

MC74VHC1G125

Noninverting 3-State Buffer

The MC74VHC1G125 is an advanced high speed CMOS noninverting 3-state buffer fabricated with silicon gate CMOS technology. It achieves high speed operation similar to equivalent Bipolar Schottky TTL while maintaining CMOS low power dissipation.

The internal circuit is composed of three stages, including a buffered 3-state output which provides high noise immunity and stable output.

The MC74VHC1G125 input structure provides protection when voltages up to 7.0 V are applied, regardless of the supply voltage. This allows the MC74VHC1G125 to be used to interface 5.0 V circuits to 3.0 V circuits.

Features

- These are Pb-Free Devices
- High Speed: $t_{PD} = 3.5$ ns (Typ) at $V_{CC} = 5.0$ V
- Low Power Dissipation: $I_{CC} = 1$ μ A (Max) at $T_A = 25^\circ$ C
- Power Down Protection Provided on Inputs
- Balanced Propagation Delays
- Pin and Function Compatible with Other Standard Logic Families
- Chip Complexity: FETs = 58; Equivalent Gates = 15

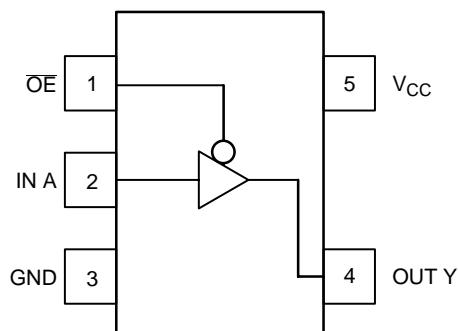

Figure 1. Pinout (Top View)

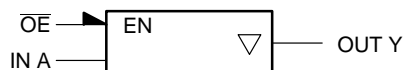

Figure 2. Logic Symbol



ON Semiconductor®

<http://onsemi.com>

MARKING DIAGRAMS

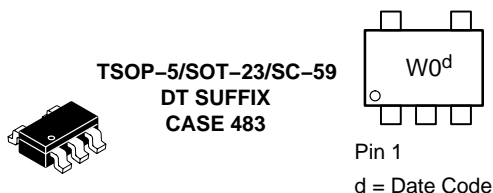
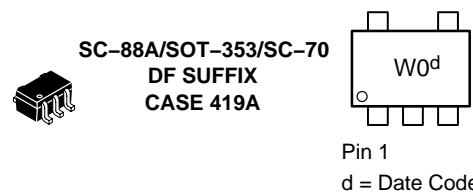

PIN ASSIGNMENT	
1	\overline{OE}
2	IN A
3	GND
4	OUT Y
5	V_{CC}

FUNCTION TABLE		
A Input	\overline{OE} Input	Y Output
L	L	L
H	L	H
X	H	Z

ORDERING INFORMATION

See detailed ordering and shipping information in the package dimensions section on page 4 of this data sheet.

MC74VHC1G125

MAXIMUM RATINGS

Symbol	Characteristics	Value	Unit
V _{CC}	DC Supply Voltage	-0.5 to +7.0	V
V _{IN}	DC Input Voltage	-0.5 to +7.0	V
V _{OUT}	DC Output Voltage V _{CC} = 0 High or Low State	-0.5 to 7.0 -0.5 to V _{CC} + 0.5	V
I _{IK}	Input Diode Current	-20	mA
I _{OK}	Output Diode Current V _{OUT} < GND; V _{OUT} > V _{CC}	+20	mA
I _{OUT}	DC Output Current, per Pin	+25	mA
I _{CC}	DC Supply Current, V _{CC} and GND	+50	mA
P _D	Power Dissipation in Still Air SC-88A, TSOP-5	200	mW
θ _{JA}	Thermal Resistance SC-88A, TSOP-5	333	°C/W
T _L	Lead Temperature, 1 mm from Case for 10 s	260	°C
T _J	Junction Temperature Under Bias	+150	°C
T _{stg}	Storage Temperature	-65 to +150	°C
V _{ESD}	ESD Withstand Voltage Human Body Model (Note 1) Machine Model (Note 2) Charged Device Model (Note 3)	> 2000 > 200 N/A	V
I _{LatchUp}	LatchUp Performance Above V _{CC} and Below GND at 125°C (Note 4)	± 500	mA

Maximum ratings are those values beyond which device damage can occur. Maximum ratings applied to the device are individual stress limit values (not normal operating conditions) and are not valid simultaneously. If these limits are exceeded, device functional operation is not implied, damage may occur and reliability may be affected.

1. Tested to EIA/JESD22-A114-A.
2. Tested to EIA/JESD22-A115-A.
3. Tested to JESD22-C101-A.
4. Tested to EIA/JESD78.

RECOMMENDED OPERATING CONDITIONS

Symbol	Characteristics	Min	Max	Unit
V _{CC}	DC Supply Voltage	2.0	5.5	V
V _{IN}	DC Input Voltage	0.0	5.5	V
V _{OUT}	DC Output Voltage	0.0	V _{CC}	V
T _A	Operating Temperature Range	-55	+125	°C
t _r , t _f	Input Rise and Fall Time V _{CC} = 3.3 V ± 0.3 V V _{CC} = 5.0 V ± 0.5 V	0	100 20	ns/V

Device Junction Temperature versus Time to 0.1% Bond Failures

Junction Temperature °C	Time, Hours	Time, Years
80	1,032,200	117.8
90	419,300	47.9
100	178,700	20.4
110	79,600	9.4
120	37,000	4.2
130	17,800	2.0
140	8,900	1.0

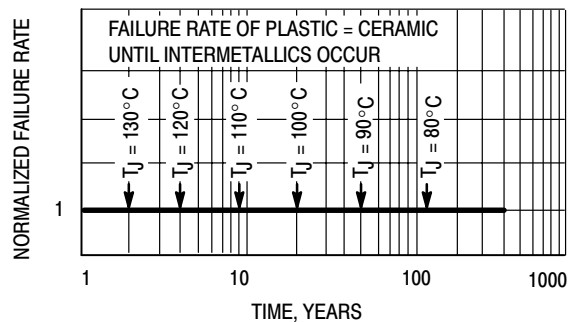

Figure 3. Failure Rate vs. Time Junction Temperature

MC74VHC1G125

DC ELECTRICAL CHARACTERISTICS

Symbol	Parameter	Test Conditions	V _{CC} (V)	T _A = 25°C			T _A ≤ 85°C		-55 ≤ T _A ≤ 125°C		Unit
				Min	Typ	Max	Min	Max	Min	Max	
V _{IH}	Minimum High-Level Input Voltage		2.0 3.0 4.5 5.5	1.5 2.1 3.15 3.85			1.5 2.1 3.15 3.85		1.5 2.1 3.15 3.85	V	
V _{IL}	Maximum Low-Level Input Voltage		2.0 3.0 4.5 5.5			0.5 0.9 1.35 1.65		0.5 0.9 1.35 1.65		0.5 0.9 1.35 1.65	V
V _{OH}	Minimum High-Level Output Voltage V _{IN} = V _{IH} or V _{IL}	V _{IN} = V _{IH} or V _{IL} I _{OH} = -50 μA	2.0 3.0 4.5	1.9 2.9 4.4	2.0 3.0 4.5		1.9 2.9 4.4		1.9 2.9 4.4	V	
		V _{IN} = V _{IH} or V _{IL} I _{OH} = -4 mA I _{OH} = -8 mA	3.0 4.5	2.58 3.94			2.48 3.80		2.34 3.66	V	
V _{OL}	Maximum Low-Level Output Voltage V _{IN} = V _{IH} or V _{IL}	V _{IN} = V _{IH} or V _{IL} I _{OL} = 50 μA	2.0 3.0 4.5		0.0 0.0 0.0	0.1 0.1 0.1		0.1 0.1 0.1		0.1 0.1 0.1	V
		V _{IN} = V _{IH} or V _{IL} I _{OL} = 4 mA I _{OL} = 8 mA	3.0 4.5			0.36 0.36	0.44 0.44		0.52 0.52	V	
I _{OZ}	Maximum 3-State Leakage Current	V _{IN} = V _{IH} or V _{IL} V _{OUT} = V _{CC} or GND	5.5			±0.25		±2.5		±2.5	μA
I _{IN}	Maximum Input Leakage Current	V _{IN} = 5.5 V or GND	0 to 5.5			±0.1		±1.0		±1.0	μA
I _{CC}	Maximum Quiescent Supply Current	V _{IN} = V _{CC} or GND	5.5			1.0		20		40	μA

AC ELECTRICAL CHARACTERISTICS C_{load} = 50 pF, Input t_r = t_f = 3.0 ns

Symbol	Parameter	Test Conditions	T _A = 25°C			T _A ≤ 85°C		-55 ≤ T _A ≤ 125°C		Unit
			Min	Typ	Max	Min	Max	Min	Max	
t _{PLH} , t _{PHL}	Maximum Propagation Delay, Input A to Y (Figures 3 and 4)	V _{CC} = 3.3 ± 0.3 V C _L = 15 pF C _L = 50 pF		4.5 6.4	8.0 11.5		9.5 13.0		12.0 16.0	ns
		V _{CC} = 5.0 ± 0.5 V C _L = 15 pF C _L = 50 pF		3.5 4.5	5.5 7.5		6.5 8.5		8.5 10.5	
t _{PZL} , t _{PZH}	Maximum Output Enable Time, Input OE to Y (Figures 4 and 5)	V _{CC} = 3.3 ± 0.3 V C _L = 15 pF R _L = 1000 Ω C _L = 50 pF		4.5 6.4	8.0 11.5		9.5 13.0		11.5 15.0	ns
		V _{CC} = 5.0 ± 0.5 V C _L = 15 pF R _L = 1000 Ω C _L = 50 pF		3.5 4.5	5.1 7.1		6.0 8.0		8.5 10.5	
t _{PLZ} , t _{PHZ}	Maximum Output Disable Time, Input OE to Y (Figures 4 and 5)	V _{CC} = 3.3 ± 0.3 V C _L = 15 pF R _L = 1000 Ω C _L = 50 pF		6.5 8.0	9.7 13.2		11.5 15.0		14.5 18.0	ns
		V _{CC} = 5.0 ± 0.5 V C _L = 15 pF R _L = 1000 Ω C _L = 50 pF		4.8 7.0	6.8 8.8		8.0 10.0		10.0 12.0	
C _{IN}	Maximum Input Capacitance			4.0	10		10		10	pF
C _{OUT}	Maximum 3-State Output Capacitance (Output in High Impedance State)			6.0						pF

C _{PD}	Power Dissipation Capacitance (Note 5)	Typical @ 25°C, V_{CC} = 5.0 V	pF
		8.0	

5. C_{PD} is defined as the value of the internal equivalent capacitance which is calculated from the operating current consumption without load. Average operating current can be obtained by the equation: I_{CC(OPR)} = C_{PD} • V_{CC} • f_{in} + I_{CC}. C_{PD} is used to determine the no-load dynamic power consumption; P_D = C_{PD} • V_{CC}² • f_{in} + I_{CC} • V_{CC}.

MC74VHC1G125

SWITCHING WAVEFORMS

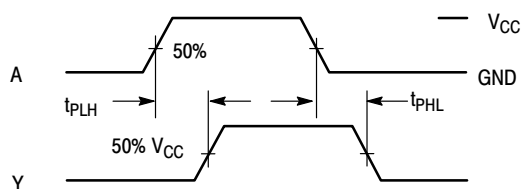

Figure 4. Switching Wave Forms

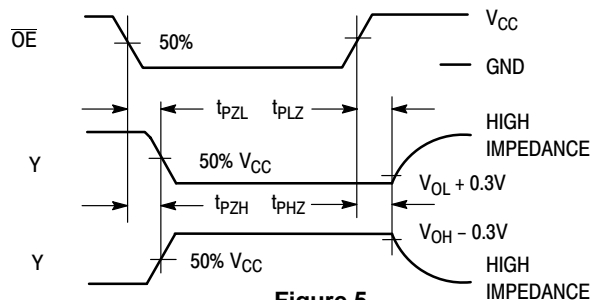
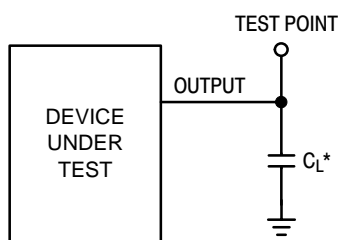
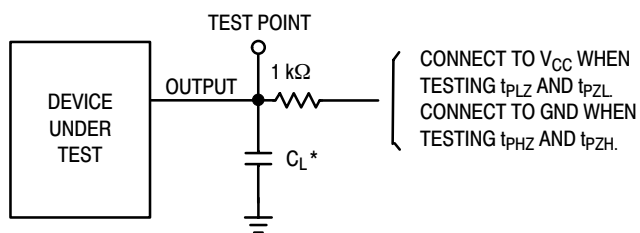

Figure 5.



*Includes all probe and jig capacitance

Figure 6. Test Circuit



*Includes all probe and jig capacitance

Figure 7. Test Circuit

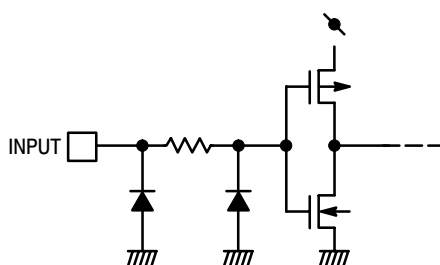

Figure 8. Input Equivalent Circuit

DEVICE ORDERING INFORMATION

Device Order Number	Device Nomenclature						Package Type (Name/SOT#/Common Name)	Tape and Reel Size†
	Circuit Indicator	Temp Range Identifier	Technology	Device Function	Package Suffix	Tape & Reel Suffix		
MC74VHC1G125DFT1	MC	74	VHC1G	125	DF	T1	SC-88A/SOT-353 /SC-70	178 mm (7") 3000 Unit
MC74VHC1G125DFT1G	MC	74	VHC1G	125	DF	T1	SC-88A/SOT-353 /SC-70 (Pb-Free)	178 mm (7") 3000 Unit
MC74VHC1G125DFT2	MC	74	VHC1G	125	DF	T2	SC-88A/SOT-353 /SC-70	178 mm (7") 3000 Unit
MC74VHC1G125DFT2G	MC	74	VHC1G	125	DF	T2	TSC-88A/SOT-353 /SC-70 (Pb-Free)	178 mm (7") 3000 Unit
MC74VHC1G125DTT1	MC	74	VHC1G	125	DT	T1	TSOP-5/SOT-23 /SC-59	178 mm (7") 3000 Unit
MC74VHC1G125DTT1G	MC	74	VHC1G	125	DT	T1	TSOP-5/SOT-23 /SC-59 (Pb-Free)	178 mm (7") 3000 Unit

†For information on tape and reel specifications, including part orientation and tape sizes, please refer to our Tape and Reel Packaging Specifications Brochure, BRD8011/D.

MC74VHC1G125

PACKAGE DIMENSIONS

SC70-5/SC-88A/SOT-353
 DF SUFFIX
 5-LEAD PACKAGE
 CASE 419A-02
 ISSUE G

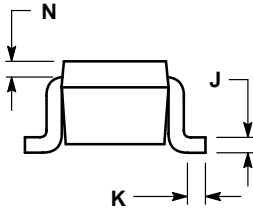
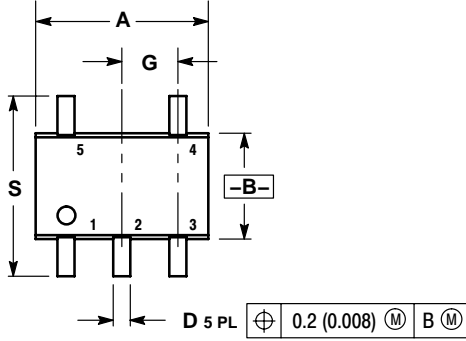

NOTES:

1. DIMENSIONING AND TOLERANCING PER ANSI Y14.5M, 1982.
2. CONTROLLING DIMENSION: INCH.
3. 419A-01 OBSOLETE. NEW STANDARD 419A-02.
4. DIMENSIONS A AND B DO NOT INCLUDE MOLD FLASH, PROTRUSIONS, OR GATE BURRS.

DIM	INCHES		MILLIMETERS	
	MIN	MAX	MIN	MAX
A	0.071	0.087	1.80	2.20
B	0.045	0.053	1.15	1.35
C	0.031	0.043	0.80	1.10
D	0.004	0.012	0.10	0.30
G	0.026 BSC		0.65 BSC	
H	---	0.004	---	0.10
J	0.004	0.010	0.10	0.25
K	0.004	0.012	0.10	0.30
N	0.008 REF		0.20 REF	
S	0.079	0.087	2.00	2.20

SOLDERING FOOTPRINT*

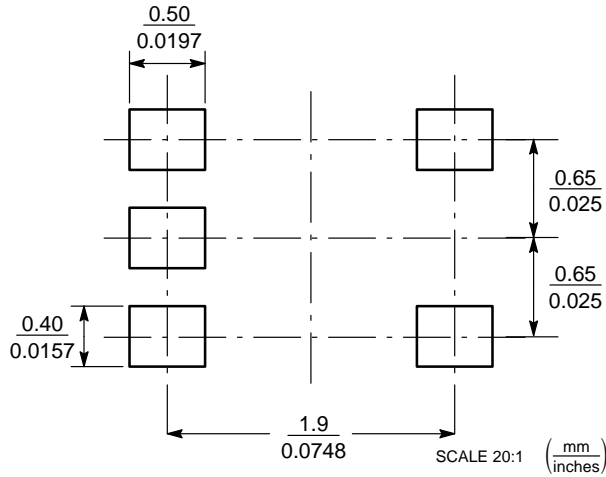

*For additional information on our Pb-Free strategy and soldering details, please download the ON Semiconductor Soldering and Mounting Techniques Reference Manual, SOLDERRM/D.

MC74VHC1G125

PACKAGE DIMENSIONS

SOT23-5/TSOP-5/SC59-5
DT SUFFIX
5-LEAD PACKAGE
CASE 483-02
ISSUE C

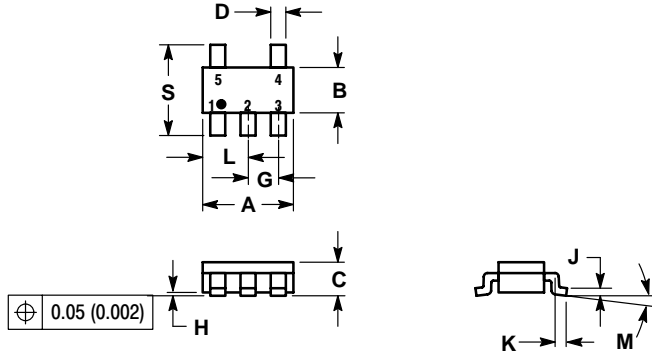

NOTES:

1. DIMENSIONING AND TOLERANCING PER ANSI Y14.5M, 1982.
2. CONTROLLING DIMENSION: MILLIMETER.
3. MAXIMUM LEAD THICKNESS INCLUDES LEAD FINISH THICKNESS. MINIMUM LEAD THICKNESS IS THE MINIMUM THICKNESS OF BASE MATERIAL.
4. A AND B DIMENSIONS DO NOT INCLUDE MOLD FLASH, PROTRUSIONS, OR GATE BURRS.

DIM	MILLIMETERS		INCHES	
	MIN	MAX	MIN	MAX
A	2.90	3.10	0.1142	0.1220
B	1.30	1.70	0.0512	0.0669
C	0.90	1.10	0.0354	0.0433
D	0.25	0.50	0.0098	0.0197
G	0.85	1.05	0.0335	0.0413
H	0.013	0.100	0.0005	0.0040
J	0.10	0.26	0.0040	0.0102
K	0.20	0.60	0.0079	0.0236
L	1.25	1.55	0.0493	0.0610
M	0	10	0	10
S	2.50	3.00	0.0985	0.1181

SOLDERING FOOTPRINT*

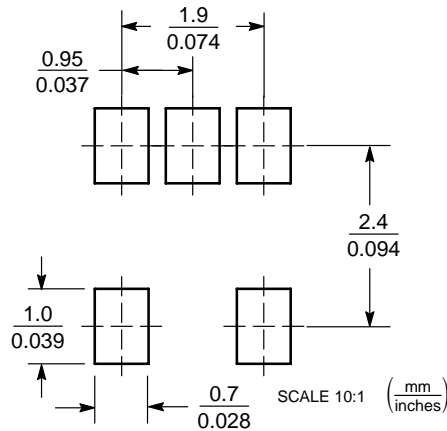

*For additional information on our Pb-Free strategy and soldering details, please download the ON Semiconductor Soldering and Mounting Techniques Reference Manual, SOLDERRM/D.

ON Semiconductor and  are registered trademarks of Semiconductor Components Industries, LLC (SCILLC). SCILLC reserves the right to make changes without further notice to any products herein. SCILLC makes no warranty, representation or guarantee regarding the suitability of its products for any particular purpose, nor does SCILLC assume any liability arising out of the application or use of any product or circuit, and specifically disclaims any and all liability, including without limitation special, consequential or incidental damages. "Typical" parameters which may be provided in SCILLC data sheets and/or specifications can and do vary in different applications and actual performance may vary over time. All operating parameters, including "Typicals" must be validated for each customer application by customer's technical experts. SCILLC does not convey any license under its patent rights nor the rights of others. SCILLC products are not designed, intended, or authorized for use as components in systems intended for surgical implant into the body, or other applications intended to support or sustain life, or for any other application in which the failure of the SCILLC product could create a situation where personal injury or death may occur. Should Buyer purchase or use SCILLC products for any such unintended or unauthorized application, Buyer shall indemnify and hold SCILLC and its officers, employees, subsidiaries, affiliates, and distributors harmless against all claims, costs, damages, and expenses, and reasonable attorney fees arising out of, directly or indirectly, any claim of personal injury or death associated with such unintended or unauthorized use, even if such claim alleges that SCILLC was negligent regarding the design or manufacture of the part. SCILLC is an Equal Opportunity/Affirmative Action Employer. This literature is subject to all applicable copyright laws and is not for resale in any manner.

PUBLICATION ORDERING INFORMATION

LITERATURE FULFILLMENT:

Literature Distribution Center for ON Semiconductor
P.O. Box 61312, Phoenix, Arizona 85082-1312 USA
Phone: 480-829-7710 or 800-344-3860 Toll Free USA/Canada
Fax: 480-829-7709 or 800-344-3867 Toll Free USA/Canada
Email: orderlit@onsemi.com

N. American Technical Support: 800-282-9855 Toll Free
USA/Canada

Japan: ON Semiconductor, Japan Customer Focus Center
2-9-1 Kamimeguro, Meguro-ku, Tokyo, Japan 153-0051
Phone: 81-3-5773-3850

ON Semiconductor Website: <http://onsemi.com>

Order Literature: <http://www.onsemi.com/litorder>

For additional information, please contact your local Sales Representative.