

Standalone Li-Ion Switch Mode Battery Charger

June 2003

FEATURES

- Wide Input Supply Range: 4.7V to 24V
- High Efficiency Current Mode PWM Controller with 500kHz Switching Frequency
- $\pm 1\%$ Charge Voltage Accuracy
- End-of-Charge Current Detection Output
- 3 Hour Charge Termination Timer
- Constant Switching Frequency for Minimum Noise
- $\pm 5\%$ Charge Current Accuracy
- Low 10 μ A Reverse Battery Drain Current
- Automatic Battery Recharge
- Automatic Shutdown When Input Supply is Removed
- Automatic Trickle Charging of Low Voltage Batteries
- Battery Temperature Sensing and Charge Qualification
- Stable with Ceramic Output Capacitor
- 8-Lead SO and 10-Lead DFN Packages

APPLICATIONS

- Portable Computers
- Charging Docks
- Handheld Instruments

DESCRIPTION

The LTC[®]4002-4.2 is a complete battery charger controller for single cell 4.2V lithium-ion batteries. With a 500kHz switching frequency, the LTC4002-4.2 provides a small, simple and efficient solution to fast charge Li-Ion batteries from a wide range of supply voltages. An external sense resistor sets the charge current with $\pm 5\%$ accuracy. An internal resistor divider and precision reference set the final float voltage to 4.2V with $\pm 1\%$ accuracy.

When the input supply is removed, the LTC4002-4.2 automatically enters a low current sleep mode, dropping the battery drain current to 10 μ A. An internal comparator detects the near end-of-charge condition while an internal timer sets the total charge time and terminates the charge cycle. After the charge cycle ends, if the battery voltage drops below 4.05V, a new charge cycle will automatically begin.

The LTC4002-4.2 is available in the 8-lead SO and 10-lead DFN packages.

 LTC and LT are registered trademarks of Linear Technology Corporation.

TYPICAL APPLICATION

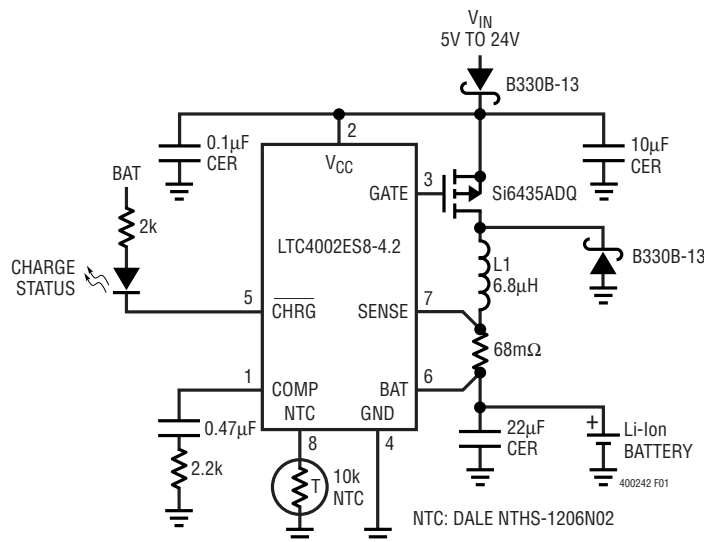
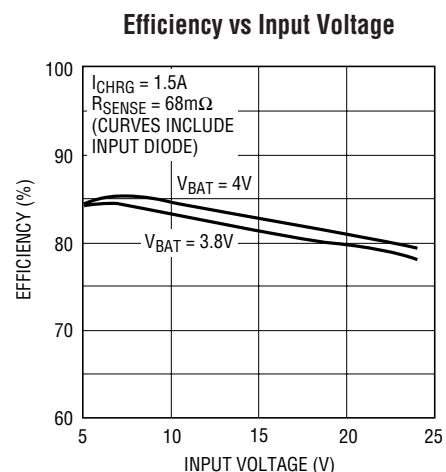

Figure 1. 1.5A Single Cell Li-Ion Battery Charger



400242 TA02

LTC4002-4.2

ABSOLUTE MAXIMUM RATINGS (Note 1)

Supply Voltage (V_{CC})	24V	Operating Temperature Range (Note 2) ..	-40°C to 85°C
GATE	$(V_{CC} - 8\text{V})$ to V_{CC}	Storage Temperature Range	-65°C to 150°C
BAT, SENSE	-0.3V to 14V	Lead Temperature (Soldering, 10 sec)	300°C
CHRG, COMP, NTC	-0.3V to 8V		

PACKAGE/ORDER INFORMATION

<p>DD PACKAGE 10-LEAD (3mm x 3mm) PLASTIC DFN $T_{JMAX} = 125^{\circ}\text{C}$, $\theta_{JA} = 43^{\circ}\text{C/W}$ EXPOSED PAD IS GND (PIN 11) MUST BE SOLDERED TO PCB</p>	ORDER PART NUMBER	<p>S8 PACKAGE 8-LEAD PLASTIC SO $T_{JMAX} = 125^{\circ}\text{C}$, $\theta_{JA} = 110^{\circ}\text{C/W}$</p>	ORDER PART NUMBER
	LTC4002EDD-4.2		LTC4002ES8-4.2
	DD PART MARKING		S8 PART MARKING
	LAGG		400242

Consult LTC Marketing for parts specified with wider operating temperature ranges.

ELECTRICAL CHARACTERISTICS

The ● denotes the specifications which apply over the full operating temperature range, otherwise specifications are at $T_A = 25^{\circ}\text{C}$. $V_{CC} = 10\text{V}$ unless otherwise noted.

SYMBOL	PARAMETER	CONDITIONS	MIN	TYP	MAX	UNITS	
V_{CC}	V_{CC} Supply Voltage		● 4.7		24	V	
I_{CC}	V_{CC} Supply Current	Current Mode		3	5	mA	
		Shutdown Mode		3	5	mA	
		Sleep Mode		10	20	μA	
V_{BAT}	Battery Regulated Float Voltage	$5\text{V} \leq V_{CC} \leq 24\text{V}$ (Note 2)	● 4.168	4.2	4.232	V	
			● 4.158		4.242	V	
$V_{SNS(CHG)}$	Constant Current Sense Voltage	$3\text{V} \leq V_{BAT} \leq 4\text{V}$ (Note 3) $0^{\circ}\text{C} \leq T_A \leq 85^{\circ}\text{C}$ $-40^{\circ}\text{C} \leq T_A \leq 85^{\circ}\text{C}$	● 93	100	107	mV	
			● 90		110	mV	
$V_{SNS(TRKL)}$	Trickle Current Sense Voltage	$V_{BAT} = 0\text{V}$ (Note 3)		5	10	15	mV
V_{TRKL}	Trickle Charge Threshold Voltage	V_{BAT} Rising		2.75	2.9	3.05	V
V_{UV}	V_{CC} Undervoltage Lockout Threshold Voltage	V_{CC} Rising		3.9	4.2	4.5	V
ΔV_{UV}	V_{CC} Undervoltage Lockout Hysteresis Voltage			200		mV	
V_{MSD}	Manual Shutdown Threshold Voltage	COMP Pin Falling		200	360	500	mV
V_{ASD}	Automatic Shutdown Threshold Voltage	$V_{CC} - V_{BAT}$		250		mV	
I_{COMP}	COMP Pin Output Current	$V_{COMP} = 1.2\text{V}$		100		μA	
I_{CHRG}	CHRG Pin Weak Pull-Down Current	$V_{CHRG} = 1\text{V}$		15	25	35	μA
V_{CHRG}	CHRG Pin Output Low Voltage	$I_{CHRG} = 1\text{mA}$		0.15	0.3	V	
R_{EOC}	End-of-Charge Ratio	$V_{SNS(EOC)}/V_{SNS(CHG)}$		10	25	32	%
t_{TIMER}	Charge Time Accuracy				10	%	

400242i

ELECTRICAL CHARACTERISTICS

The ● denotes the specifications which apply over the full operating temperature range, otherwise specifications are at $T_A = 25^\circ\text{C}$. $V_{CC} = 10\text{V}$ unless otherwise noted.

SYMBOL	PARAMETER	CONDITIONS	MIN	TYP	MAX	UNITS
I_{NTC}	NTC Pin Output Current	$V_{\text{NTC}} = 0.85\text{V}$	● 75	85	95	μA
$V_{\text{NTC-HOT}}$	NTC Pin Threshold Voltage (Hot)	V_{NTC} Falling Hysteresis	● 340	355 25	370	mV mV
$V_{\text{NTC-COLD}}$	NTC Pin Threshold Voltage (Cold)	V_{NTC} Rising Hysteresis	● 2.428	2.465 170	2.502	V mV
ΔV_{RECHRG}	Recharge Battery Voltage Offset from Full Charged Battery Voltage	$V_{\text{BAT(FULLCHARGED)}} - V_{\text{RECHRG}}$, V_{BAT} Falling	100	150	200	mV
I_{LEAK}	CHRG Pin Leakage Current	$V_{\text{CHRG}} = 8\text{V}$, Charging Stops			1	μA

Oscillator

f_{OSC}	Switching Frequency		450	500	550	kHz
DC	Maximum Duty Cycle				100	%

Gate Drive

t_r	Rise Time	$C_{\text{GATE}} = 2000\text{pF}$, 10% to 90%		20		ns
t_f	Fall Time	$C_{\text{GATE}} = 2000\text{pF}$, 90% to 10%		50		ns
ΔV_{GATE}	Output Clamp Voltage	$V_{CC} - V_{\text{GATE}}$, $V_{CC} \geq 9\text{V}$	●		8	V
ΔV_{GATEHI}	Output High Voltage	$\Delta V_{\text{GATEHI}} = V_{CC} - V_{\text{GATE}}$, $V_{CC} \geq 7\text{V}$	●		0.3	V
ΔV_{GATELO}	Output Low Voltage	$\Delta V_{\text{GATELO}} = V_{CC} - V_{\text{GATE}}$, $V_{CC} \geq 7\text{V}$	●	4.5		V

Note 1: Absolute Maximum Rating are those values beyond which the life of a device may be impaired.

Note 2: The LTC4002-4.2 is tested with Test Circuit 1.

Note 3: The LTC4002-4.2 is tested with Test Circuit 2.

TYPICAL PERFORMANCE CHARACTERISTICS

$T_A = 25^\circ\text{C}$, $V_{CC} = 10\text{V}$ unless otherwise noted.

Supply Current vs Temperature

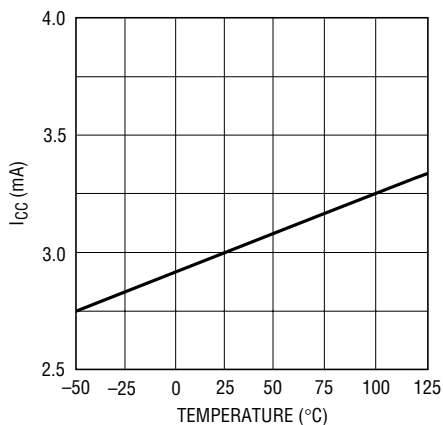

400242 G01

Supply Current vs V_{CC}

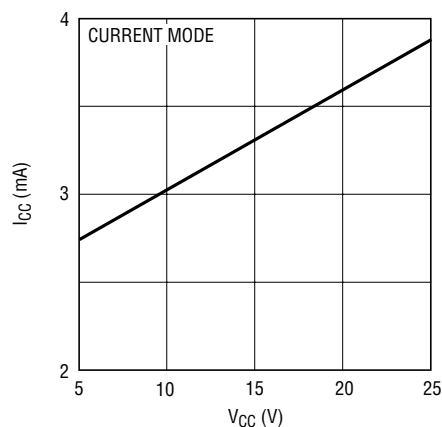

400242 G02

Oscillator Frequency vs Temperature

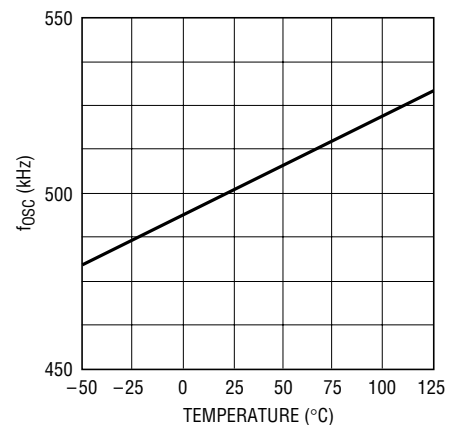

400242 G03

TYPICAL PERFORMANCE CHARACTERISTICS $T_A = 25^\circ\text{C}$, $V_{CC} = 10\text{V}$ unless otherwise noted.

Oscillator Frequency vs V_{CC}

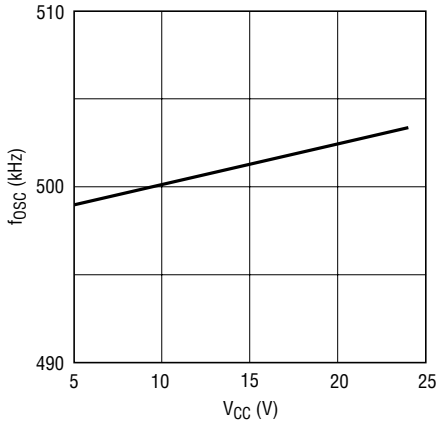

400242 G04

Current Mode Sense Voltage vs Temperature

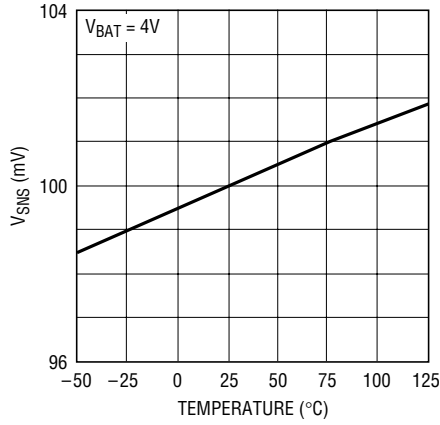

400242 G05

Current Mode Sense Voltage vs V_{CC}

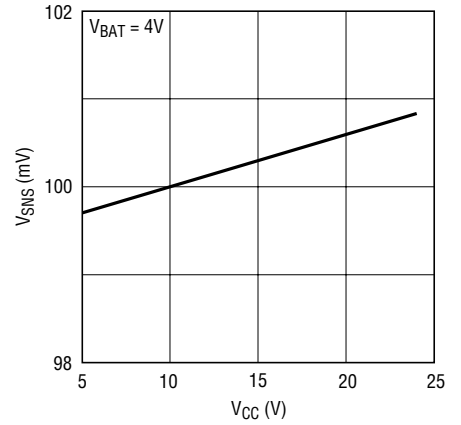

400242 G04

Trickle Charge Voltage vs Temperature

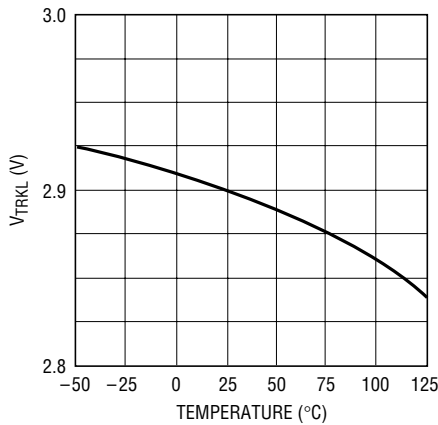

400242 G07

Trickle Charge Voltage vs V_{CC}

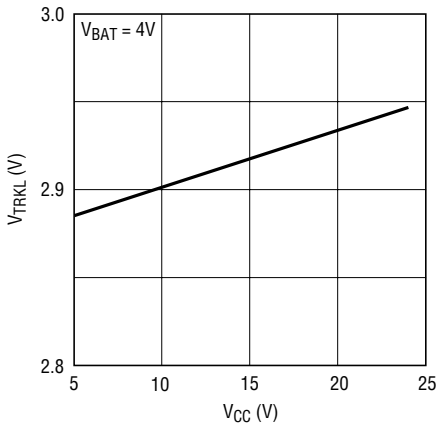

400242 G08

CHRG Pin Output Low Voltage vs V_{CC}

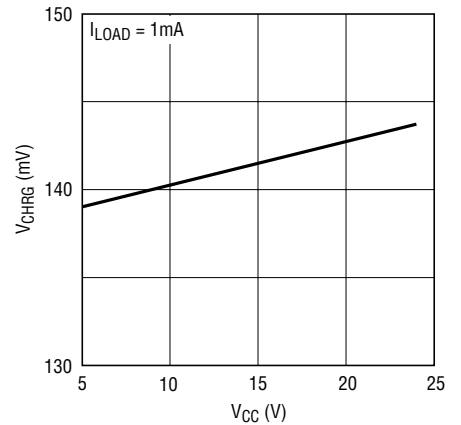

400242 G09

CHRG Pin Output Low Voltage vs Temperature

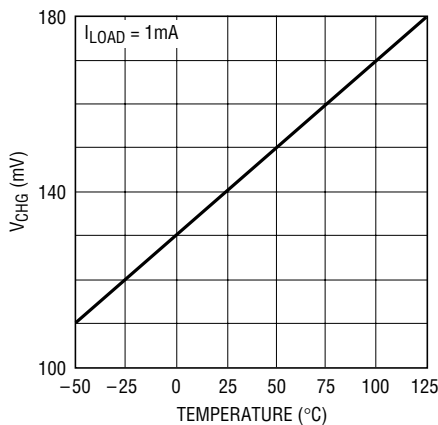

400242 G10

CHRG Pin Weak Pull-Down Current vs Temperature

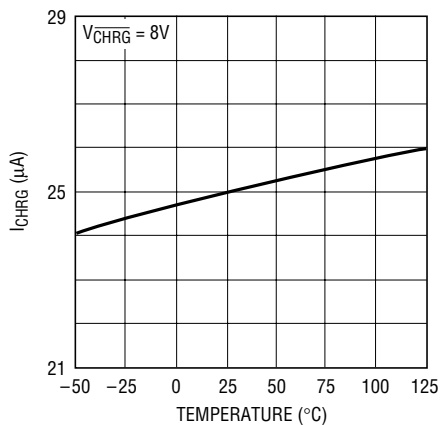

400242 G23

CHRG Output Pin Weak Pull-Down Current vs V_{CC}

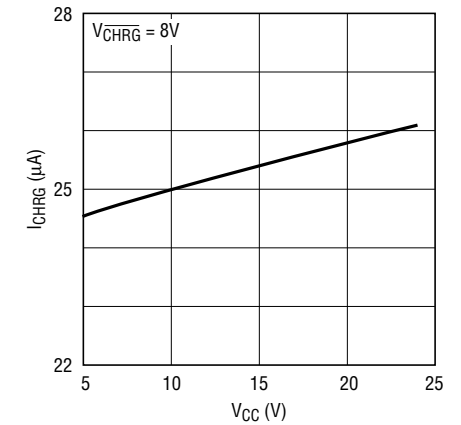

400242 G11

TYPICAL PERFORMANCE CHARACTERISTICS $T_A = 25^\circ\text{C}$, $V_{CC} = 10\text{V}$ unless otherwise noted.

Trickle Charge Sense Voltage vs Temperature

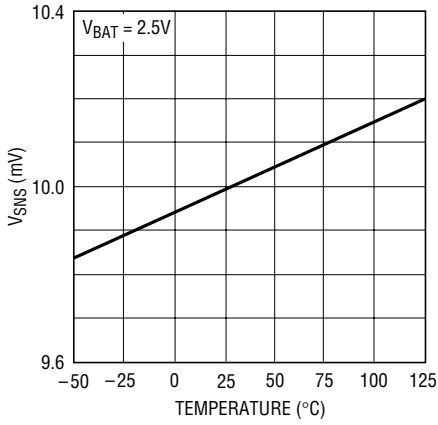

400242 G12

Trickle Charge Sense Voltage vs V_{CC}

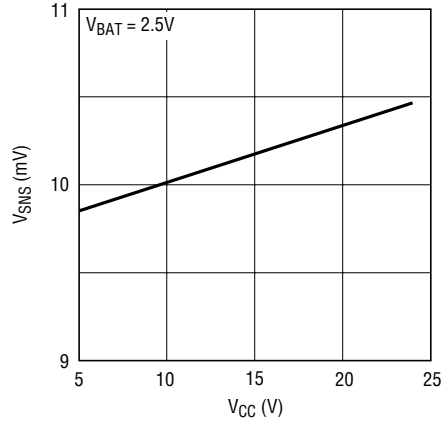

400242 G13

COMP Pin Output Current vs V_{CC}

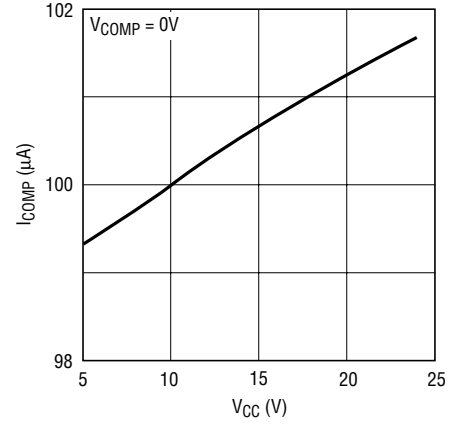

400242 G14

COMP Pin Output Current vs Temperature

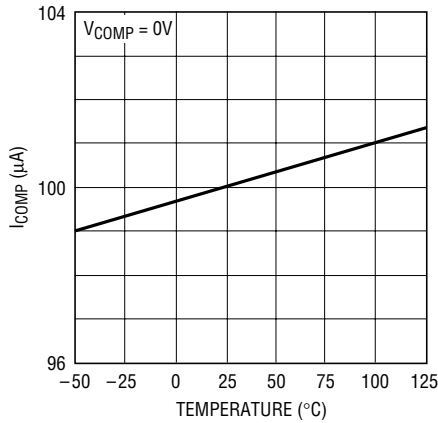

400242 G15

NTC Pin Output Current vs V_{CC}

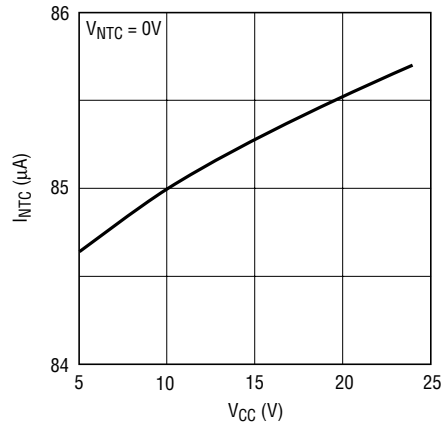

400242 G16

NTC Pin Output Current vs Temperature

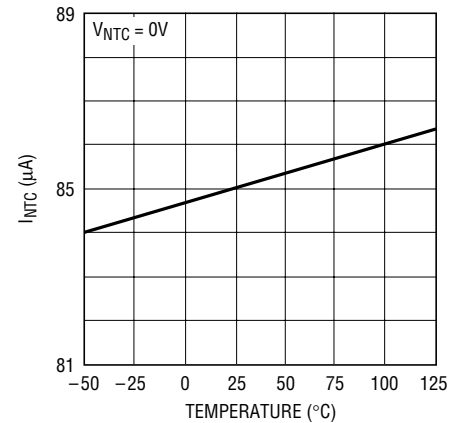

400242 G17

Recharge Voltage Offset from Full Charged Voltage vs Temperature

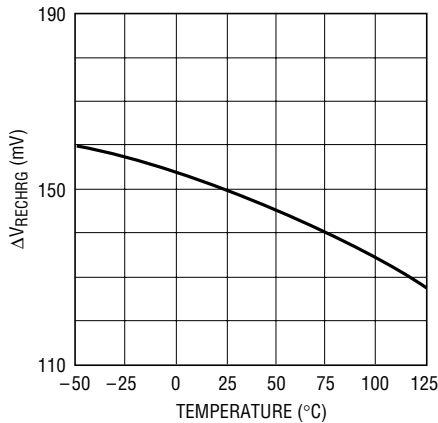

400242 G18

Recharge Voltage Offset from Full Charged Voltage vs V_{CC}

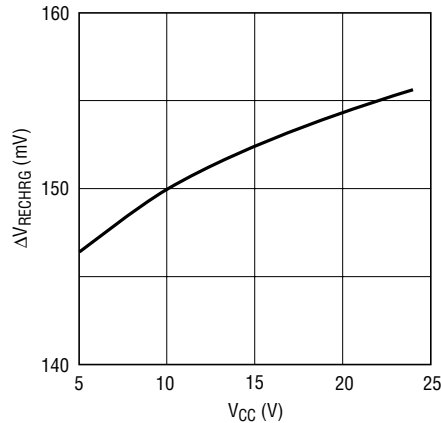

400242 G19

End-of-Charge Ratio vs Temperature

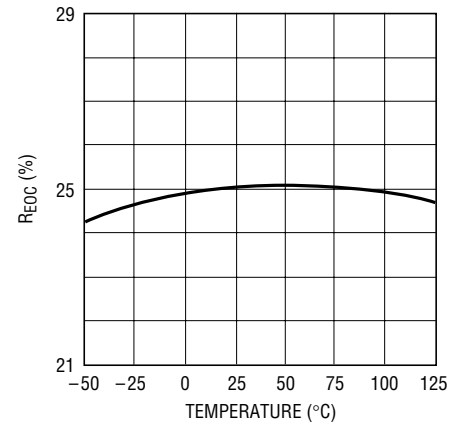

400242 G20

TYPICAL PERFORMANCE CHARACTERISTICS $T_A = 25^\circ\text{C}$, $V_{CC} = 10\text{V}$ unless otherwise noted.

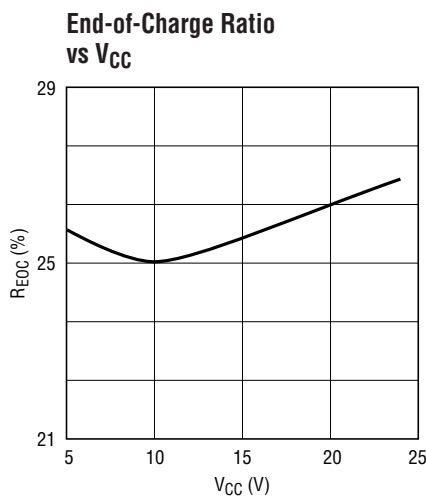

400242 G21

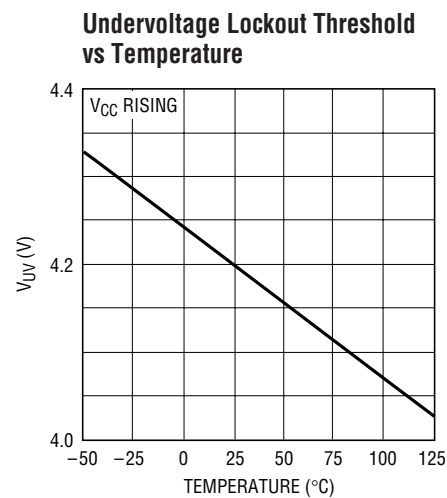

400242 G22

PIN FUNCTIONS (DFN/SO-8)

COMP (Pin 1/Pin 1): Compensation, Soft-Start and Shut-down Control Pin. The COMP pin is the control signal of the inner loop of the current mode PWM. Charging begins when the COMP pin reaches 800mV. The recommended compensation components are a 0.47 μF (or larger) capacitor and a 2.2k series resistor. A 100 μA current into the compensation capacitor also sets the soft-start slew rate. Pulling the COMP pin below 350mV will shut down the charger.

V_{CC} (Pin 2/Pin 2): Positive Supply Voltage Input. V_{CC} can range from 4.7V to 24V. A 0.1 μF or higher capacitor is required at the V_{CC} pin with the lead length kept to a minimum. A 10 μF low ESR capacitor is also required at the source pins of the power P-channel MOSFET.

GATE (Pin 3/Pin 3): Gate Drive Output. Driver Output for the P-Channel MOSFET. The voltage at this pin is internally clamped to 8V below V_{CC} , allowing a low voltage MOSFET with gate-to-source breakdown voltage of 8V or less to be used.

PGND, SGND, Exposed Pad, GND (Pins 4, 5, 11/4): IC Ground.

CHRG (Pin 6/Pin 5): Open-Drain Charge Status Output. When the battery is being charged, the CHRG pin is pulled low by an internal N-channel MOSFET. When the charge current drops to 25% of the full-scale current for more than

120 μs , the N-channel MOSFET turns off and a 25 μA current source is connected from the $\overline{\text{CHRG}}$ pin to GND. When the timer runs out or the input supply is removed, the 25 μA current source is turned off and the $\overline{\text{CHRG}}$ pin becomes high impedance.

BAT (Pin 7/Pin 6): Battery Sense Input. A bypass capacitor of 22 μF is required to minimize ripple voltage. An internal resistor divider, which is disconnected in sleep mode, sets the final float voltage at this pin. If the battery connection is opened when charging, an overvoltage circuit will limit the charger output voltage to 10% above the programmed float voltage.

When V_{BAT} is within 250mV of V_{CC} , the LTC4002-4.2 is forced into sleep mode, dropping I_{CC} to 10 μA .

SENSE (Pin 8/Pin 7): Current Amplifier Sense Input. A sense resistor, R_{SENSE} , must be connected between the SENSE and BAT pins. The maximum charge current is equal to 100mV/ R_{SENSE} .

NTC (Pin 9/Pin 8): NTC (Negative Temperature Coefficient) Thermistor Input. With an external 10k Ω NTC thermistor to ground, this pin senses the temperature of the battery pack and stops the charger when the temperature is out of range. When the voltage at this pin drops below 350mV at

PIN FUNCTIONS (DFN/SO-8)

hot temperature or rises above 2.465V at cold temperature, charging is suspended and the internal timer stops. The CHRG pin output is not affected during this hold state. To

disable the temperature qualification function, ground the NTC pin.

NC (Pin 10/NA): No Connect.

BLOCK DIAGRAM

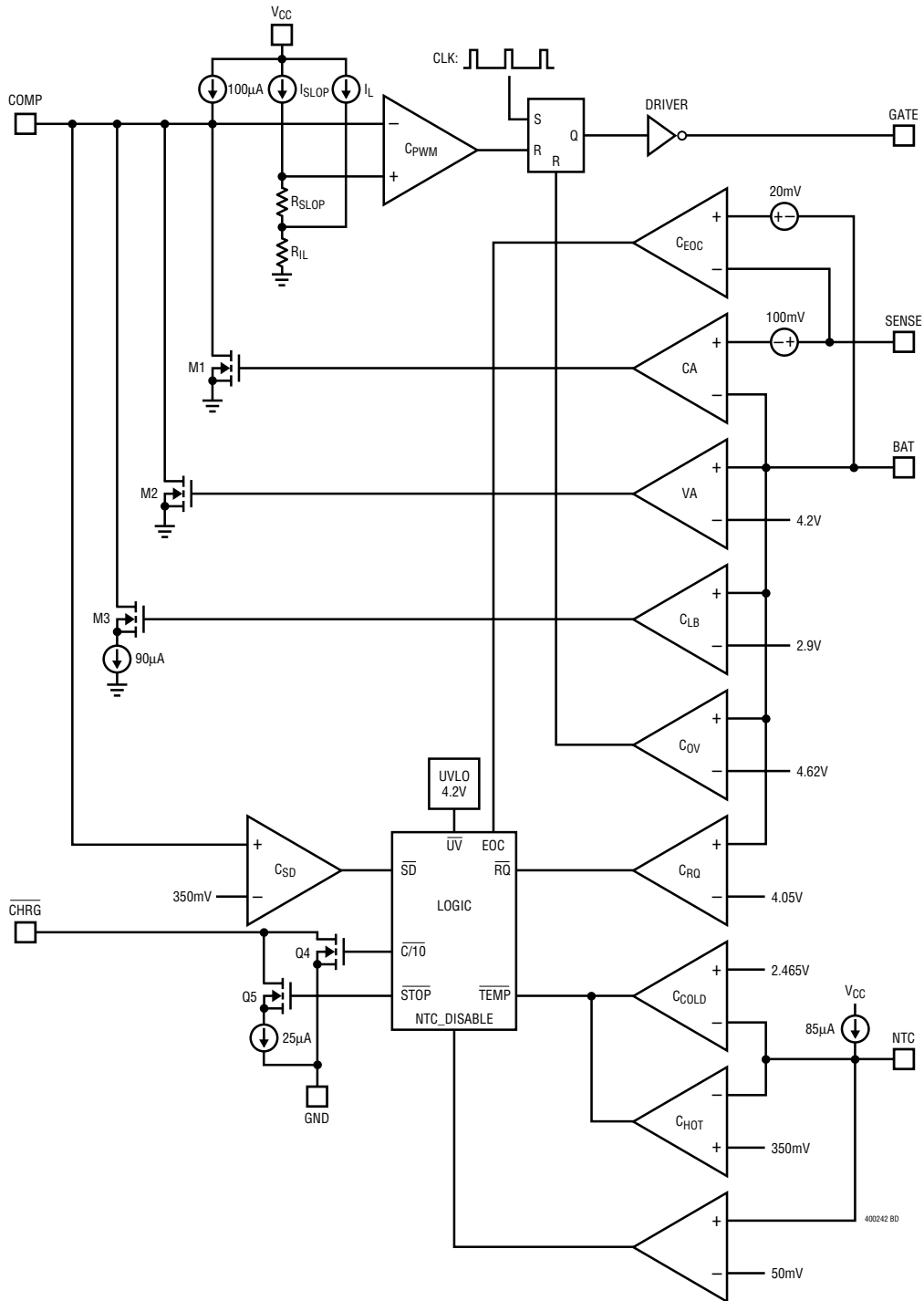

TEST CIRCUITS

Test Circuit 1

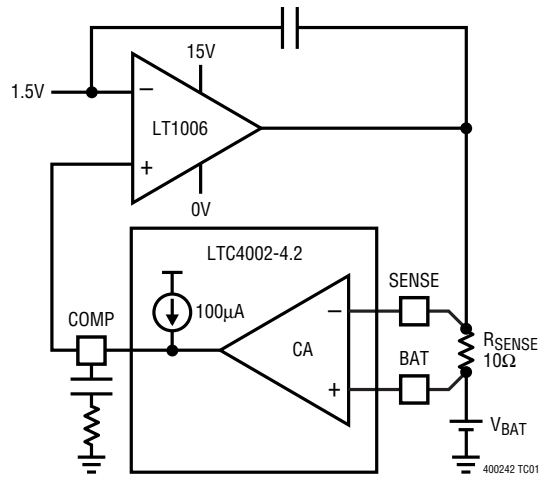

Test Circuit 2

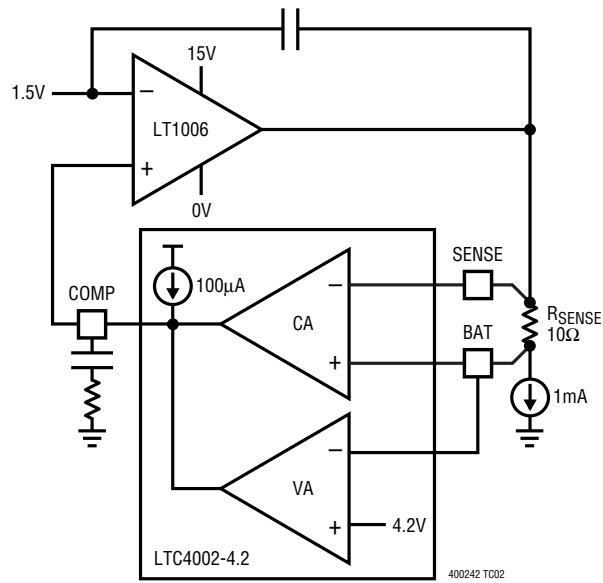

OPERATION

The LTC4002 is a constant current, constant voltage Li-Ion battery charger controller that uses a current mode PWM step-down (buck) switching architecture. The charge current is set by an external sense resistor (R_{SENSE}) across the SENSE and BAT pins. The final battery float voltage is internally set to 4.2V. For batteries like lithium-ion that require accurate final float voltage, the internal 2.465V reference, voltage amplifier and the resistor divider provide regulation with $\pm 1\%$ accuracy.

A charge cycle begins when the voltage at the V_{CC} pin rises above the UVLO level (4.2V) and is 250mV or more greater than the battery voltage. At the beginning of the charge cycle, if the battery voltage is less than 2.9V, the charger goes into trickle charge mode. The trickle charge current is internally set to 10% of the full-scale current. If the battery voltage stays low for 30 minutes, the battery is considered faulty and the charge cycle is terminated.

When the battery voltage exceeds 2.9V, the charger goes into the full-scale constant current charge mode. In constant current mode, the charge current is set by the external sense resistor R_{SENSE} and an internal 100mV reference; $I_{\text{BAT}} = 100\text{mV}/R_{\text{SENSE}}$.

When the battery voltage approaches the programmed float voltage, the charge current will start to decrease.

When the current drops to 25% of the full-scale charge current, an internal comparator turns off the internal pull-down N-channel MOSFET at the $\overline{\text{CHRG}}$ pin, and connects a weak current source to ground to indicate a near end-of-charge condition.

An internal 3 hour timer determines the total charge time. After a time out occurs, the charge cycle is terminated and the $\overline{\text{CHRG}}$ pin is forced high impedance. To restart the charge cycle, remove and reapply the input voltage or momentarily shut the charger down. Also, a new charge cycle will begin if the battery voltage drops below the recharge threshold voltage of 4.05V.

When the input voltage is present, the charger can be shut down ($I_{\text{CC}} = 3\text{mA}$) by pulling the COMP pin low. When the input voltage is not present, the charger goes into sleep mode, dropping I_{CC} to 10 μA . This will greatly reduce the current drain on the battery and increase the standby time.

A 10k Ω NTC (negative temperature coefficient) thermistor can be connected from the NTC pin to ground for battery temperature qualification. The charge cycle is suspended when the temperature is outside of the 0 $^{\circ}\text{C}$ to 50 $^{\circ}\text{C}$ window (with DALE NTHS-1206N02).

APPLICATIONS INFORMATION

Undervoltage Lockout (UVLO)

An undervoltage lockout circuit monitors the input voltage and keeps the charger off until V_{CC} rises above 4.2V and at least 250mV above the battery voltage. To prevent oscillation around the threshold voltage, the UVLO circuit has 200mV of built-in hysteresis.

Trickle Charge and Defective Battery Detection

At the beginning of a charge cycle, if the battery voltage is below 2.9V, the charger goes into trickle charge mode with the charge current reduced to 10% of the full-scale current. If the low-battery voltage persists for 30 minutes, the battery is considered defective, the charge cycle is terminated and the $\overline{\text{CHRG}}$ pin is forced to be high impedance.

Shutdown

The LTC4002 can be shut down by pulling the COMP pin to ground which pulls the GATE pin high and turns off the external P-channel MOSFET. When the COMP pin is released, the internal timer is reset and a new charge cycle starts. In shutdown, the output of the $\overline{\text{CHRG}}$ pin is high impedance and the quiescent current remains at 3mA.

Removing the input power supply will put the charger into sleep mode. If the voltage at the V_{CC} pin drops below ($V_{\text{BAT}} + 250\text{mV}$) or below the UVLO level (4.2V), the LTC4002-4.2 goes into a low current ($I_{\text{CC}} = 10\mu\text{A}$) sleep mode, reducing the battery drain current.

$\overline{\text{CHRG}}$ Status Output Pin

When a charge cycle starts, the $\overline{\text{CHRG}}$ pin is pulled to ground by an internal N-channel MOSFET which is capable of driving an LED. When the charge current drops to 25% of the full-scale current for more than 120 μs , the N-channel MOSFET turns off and a weak 25 μA current source to ground is connected to the $\overline{\text{CHRG}}$ pin. This weak 25 μA pull-down remains until the timer ends the charge cycle, or the charger is in manual shutdown or sleep mode.

After a time out occurs (charge cycle ends), the pin will go into high impedance. By using two different value resistors, a microprocessor can detect three states from this pin (charging, end-of-charge and charging stopped) see Figure 2.

To detect the charge mode, force the digital output pin, OUT, high and measure the voltage at the $\overline{\text{CHRG}}$ pin. The N-channel MOSFET will pull the pin low even with a 2k pull-up resistor. Once the charge current drops to 25% of the full-scale current, the N-channel MOSFET is turned off and a 25 μA current source is connected to the $\overline{\text{CHRG}}$ pin. The IN pin will then be pulled high by the 2k resistor connected to OUT. Now force the OUT pin into a high impedance state, the current source will pull the pin low through the 400k resistor. When the internal timer has expired, the $\overline{\text{CHRG}}$ pin changes to a high impedance state and the 400k resistor will then pull the pin high to indicate the charging has stopped.

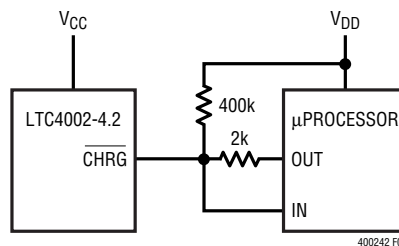

Figure 2. Microprocessor Interface

APPLICATIONS INFORMATION

Gate Drive

The LTC4002-4.2 gate driver can provide high transient currents to drive the external pass transistor. The rise and fall times are typically 20ns and 50ns respectively when driving a 2000pF load, which is typical for a P-channel MOSFET with $R_{DS(ON)}$ in the range of 50m Ω .

A voltage clamp is added to limit the gate drive to 8V below V_{CC} . For example, if V_{CC} is 10V then the GATE output will pull down to 2V max. This allows low voltage P-channel MOSFETs with superior $R_{DS(ON)}$ to be used as the pass transistor thus increasing efficiency.

Stability

Both the current loop and the voltage loop share a common, high impedance, compensation node (COMP pin). A series capacitor and resistor on this pin compensates both loops. The resistor is included to provide a zero in the loop response and boost the phase margin.

The compensation capacitor also provides a soft-start function for the charger. Upon start-up, the COMP pin voltage will quickly rise to 0.05V, due to the 2.2k series resistor, then ramp at a rate set by the internal 100 μ A pull-up current source and the external capacitor. Battery charge current starts ramping up when the COMP pin voltage reaches 0.8V and full current is achieved with the COMP pin at 1.3V. With a 0.47 μ F capacitor, time to reach full charge current is about 235ms. Capacitance can be increased up to 1 μ F if a longer start-up time is needed.

Automatic Battery Recharge

After the 3 hour charge cycle is completed and both the battery and the input power supply (wall adapter) are still connected, a new charge cycle will begin if the battery voltage drops below 4.05V due to self-discharge or external loading. This will keep the battery capacity at more than 80% at all times without manually restarting the charge cycle.

Battery Temperature Detection

A negative temperature coefficient (NTC) thermistor located close to the battery pack can be used to monitor battery temperature and will not allow charging unless the battery temperature is within an acceptable range.

Connect a 10k Ω thermistor (DALE NTHS-1206N02) from the NTC pin to ground. If the temperature rises to 50 $^{\circ}$ C, the resistance of the NTC will be approximately 4.1k Ω . With the 85 μ A pull-up current source, the Hot temperature voltage threshold is 350mV. For Cold temperature, the voltage threshold is set at 2.456V which is equal to 0 $^{\circ}$ C ($R_{NTC} \cong 28.4k\Omega$) with 85 μ A of pull-up current. If the temperature is outside the window, the GATE pin will be pulled up to V_{CC} and the timer frozen while the output status at the CHRG pin remains the same. The charge cycle begins or resumes once the temperature is within the acceptable range. Short the NTC pin to ground to disable the temperature qualification feature.

APPLICATIONS INFORMATION

Input and Output Capacitors

Since the input capacitor is assumed to absorb all input switching ripple current in the converter, it must have an adequate ripple current rating. Worst-case RMS ripple current is approximately one-half of output charge current. Actual capacitance value is not critical. Solid tantalum capacitors have a high ripple current rating in a relatively small surface mount package, but caution must be used when tantalum capacitors are used for input bypass. High input surge currents can be created when the adapter is hot-plugged to the charger and solid tantalum capacitors have a known failure mechanism when subjected to very high turn-on surge currents. Selecting the highest possible voltage rating on the capacitor will minimize problems. Consult with the manufacturer before use.

The selection of output capacitor C_{OUT} is primarily determined by the ESR required to minimize ripple voltage and load step transients. The output ripple ΔV_{OUT} is approximately bounded by:

$$\Delta V_{OUT} \leq \Delta I_L \left(ESR + \frac{1}{8f_{OSC}C_{OUT}} \right)$$

Since ΔI_L increases with input voltage, the output ripple is highest at maximum input voltage. Typically, once the ESR requirement is satisfied, the capacitance is adequate for filtering and has the necessary RMS current rating.

Switching ripple current splits between the battery and the output capacitor depending on the ESR of the output capacitor and the battery impedance. EMI considerations usually make it desirable to minimize ripple current in the battery leads. Ferrite beads or an inductor may be added to increase battery impedance at the 500kHz switching frequency. If the ESR of the output capacitor is 0.2Ω and the battery impedance is raised to 4Ω with a bead or inductor, only 5% of the current ripple will flow in the battery.

Design Example

As a design example, take a charger with the following specifications: $V_{IN} = 5V$ to $24V$, $V_{BAT} = 4V$ nominal, $I_{BAT} = 1.5A$, $f_{OSC} = 500kHz$, see Figure 1.

First, calculate the SENSE resistor :

$$R_{SENSE} = 100mV/1.5A = 68m\Omega$$

Choose the inductor for about 65% ripple current at the maximum V_{IN} :

$$L = \frac{4V}{(500kHz)(0.65)(1.5A)} \left(1 - \frac{4V}{24V} \right) = 6.838\mu H$$

Selecting a standard value of $6.8\mu H$ results in a maximum ripple current of :

$$\Delta I_L = \frac{4V}{(500kHz)(6.8\mu H)} \left(1 - \frac{4V}{24V} \right) = 980.4mA$$

APPLICATIONS INFORMATION

Next, choose the P-channel MOSFET. The Si6435ADQ in a TSSOP-8 package with $R_{DS(ON)} = 42m\Omega$ (nom), $55m\Omega$ (max) offers a small solution. The maximum power dissipation with $V_{IN} = 5V$ and $V_{BAT} = 4V$ at $50^\circ C$ ambient temperature is:

$$P_D = \frac{(1.5A)^2(55m\Omega)(4V)}{5V} = 0.099W$$

$$T_J = 50^\circ C + (0.099W)(65^\circ C/W) = 56.5^\circ C$$

C_{IN} is chosen for an RMS current rating of about 0.8A at $85^\circ C$. The output capacitor is chosen for an ESR similar to the battery impedance of about $100m\Omega$. The ripple voltage on the BAT pin is:

$$\begin{aligned} V_{OUT(RIPPLE)} &= \frac{\Delta I_{L(MAX)}(ESR)}{2} \\ &= \frac{(0.98A)(0.1\Omega)}{2} = 49mV \end{aligned}$$

C1: Taiyo Yuden TMK325BJ106MM

C2: Taiyo Yuden JMK325BJ226MM

L1: TOKO B952AS-6R8N

The Schottky diode D2 shown in Figure 1 conducts current when the pass transistor is off. In a low duty cycle case, the current rating should be the same or higher than the charge current. Also it should withstand reverse voltage as high as V_{IN} .

Board Layout Suggestions

When laying out the printed circuit board, the following considerations should be taken to ensure proper operation of the LTC4002-4.2.

GATE pin rise and fall times are 20ns and 50ns respectively (with $C_{GATE} = 2000pF$). To minimize radiation, the catch diode, pass transistor and the input bypass capacitor traces should be kept as short as possible. The positive side of the input capacitor should be close to the source of the P-channel MOSFET; it provides the AC current to the pass transistor. The connection between the catch diode and the pass transistor should also be kept as short as possible. The SENSE and BAT pins should be connected directly to the sense resistor (Kelvin sensing) for best charge current accuracy.

The compensation capacitor connected at the COMP pin should return to the ground pin of the IC or as close to it as possible. This will prevent ground noise from disrupting the loop stability. The ground pin also works as a heat sink, therefore use a generous amount of copper around the ground pin. This is especially important for high V_{CC} and/or high gate capacitance applications.

PACKAGE DESCRIPTION

DD Package
10-Lead Plastic DFN (3mm × 3mm)
 (Reference LTC DWG # 05-08-1699)

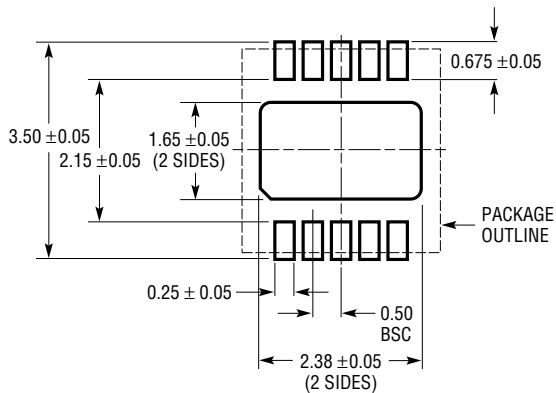

RECOMMENDED SOLDER PAD PITCH AND DIMENSIONS

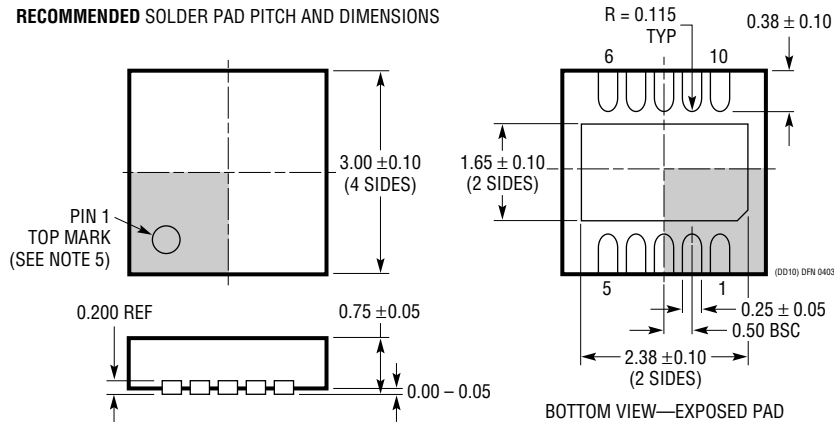

NOTE:

1. DRAWING TO BE MADE A JEDEC PACKAGE OUTLINE M0-229 VARIATION OF (WEED-2). CHECK THE LTC WEBSITE DATA SHEET FOR CURRENT STATUS OF VARIATION ASSIGNMENT
2. ALL DIMENSIONS ARE IN MILLIMETERS
3. DIMENSIONS OF EXPOSED PAD ON BOTTOM OF PACKAGE DO NOT INCLUDE MOLD FLASH. MOLD FLASH, IF PRESENT, SHALL NOT EXCEED 0.15mm ON ANY SIDE
4. EXPOSED PAD SHALL BE SOLDER PLATED
5. SHADED AREA IS ONLY A REFERENCE FOR PIN 1 LOCATION ON THE TOP AND BOTTOM OF PACKAGE

PACKAGE DESCRIPTION

S8 Package
8-Lead Plastic Small Outline (Narrow .150 Inch)
 (Reference LTC DWG # 05-08-1610)

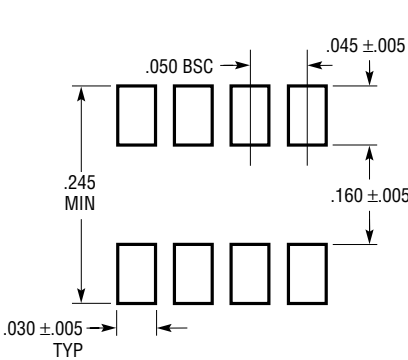

RECOMMENDED SOLDER PAD LAYOUT

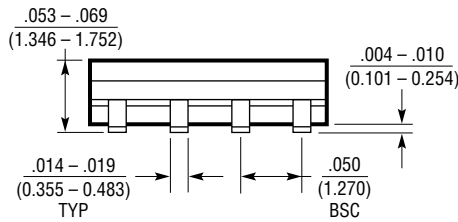
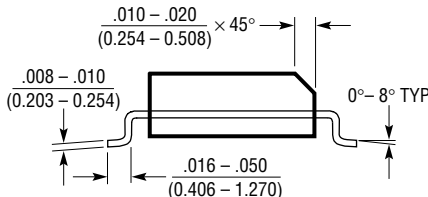
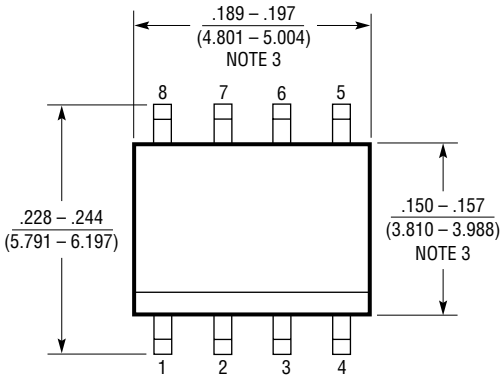

- NOTE:
 1. DIMENSIONS IN $\frac{\text{INCHES}}{\text{MILLIMETERS}}$
 2. DRAWING NOT TO SCALE
 3. THESE DIMENSIONS DO NOT INCLUDE MOLD FLASH OR PROTRUSIONS.
 MOLD FLASH OR PROTRUSIONS SHALL NOT EXCEED .006" (0.15mm)

S08 0303

TYPICAL APPLICATION

Single Cell 4.2V, 2A Li-Ion Battery Charger

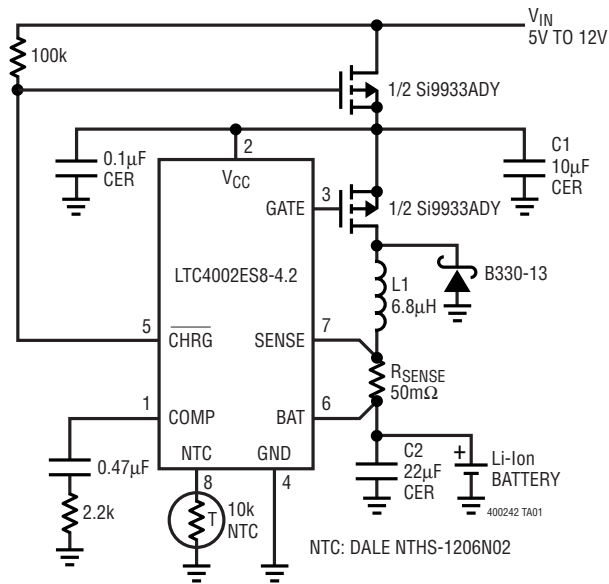

RELATED PARTS

PART NUMBER	DESCRIPTION	COMMENTS
LTC1732/LTC4050	Constant Voltage/Constant Current Li-Ion Linear Battery Chargers	Standalone Battery Charger, No uC or Firmware Required, Auto Recharge of Low Battery, 10-Pin MSOP, Input Supply Detection
LTC1733	Li-Ion Battery Charger with Thermal Regulation	Standalone Charger, Constant-Current/Constant-Voltage/Constant-Temperature, Integrated MOSFET, No External Sense Resistor or Blocking Diodes
LTC1734/LTC1734L	SOT-23 Li-Ion Battery Chargers	Need Only Two External Components, Monitors Charge Current, No Reverse Diode or Sense Resistor Required, 50mA to 700mA
LTC1980	Combination Battery Charger and DC/DC Converter	Wall Adapter May Be Above or Below Battery Voltage, Standalone, 1-, 2-Cell Li-Ion, Also for Charging NiMH and NiCd Batteries
LTC4006/LTC4007 LTC4008	4A Multiple Cell Li-Ion, NiCd, NiMH, Lead Acid Battery Chargers	$6V \leq V_{IN} \leq 28V$, High Efficiency $\geq 90\%$, $V_{OUT} \leq 28V$, Digital Interface I/O, Small Inductor
LTC4052/LTC1730	Integrated Pulse Chargers for a 1-Cell Li-Ion Battery	0.35Ω Internal N-FET Requires No Blocking Diode, Current Limit for Safety
LTC4053	USB Compatible Li-Ion Linear Battery Charger	Charges from USB Input or AC/DC, 100mA/500mA Up to 1.25A, Thermal Regulation, Fully Integrated
LTC4054	Standalone Linear Li-Ion Battery Charger with Integrated Pass Transistor in ThinSOT™	Thermal Regulation Prevents Overheating, C/10 Termination, C/10 Indicator
LTC4056	Standalone SOT-23 Li-Ion Linear Battery Charger	Charge Termination Included, $I_{CH} \leq 700mA$, 8-Lead ThinSOT Package
LTC4412	Low Loss PowerPath™ Controller in ThinSOT	Automatic Switching Between DC Sources, Simplified Load Sharing

PowerPath and ThinSOT are trademarks of Linear Technology Corporation.