

IRFPS40N60K

HEXFET® Power MOSFET

Applications

- Hard Switching Primary or PFC Switch
- Switch Mode Power Supply (SMPS)
- Uninterruptible Power Supply
- High Speed Power Switching
- Motor Drive

V_{DSS}	$R_{DS(on)}$ typ.	I_D
600V	0.110 Ω	40A

Benefits

- Low Gate Charge Q_g results in Simple Drive Requirement
- Improved Gate, Avalanche and Dynamic dv/dt Ruggedness
- Fully Characterized Capacitance and Avalanche Voltage and Current
- Enhanced Body Diode dv/dt Capability

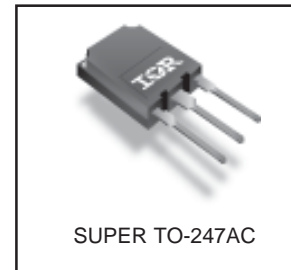

Absolute Maximum Ratings

	Parameter	Max.	Units
I_D @ $T_C = 25^\circ\text{C}$	Continuous Drain Current, V_{GS} @ 10V	40	A
I_D @ $T_C = 100^\circ\text{C}$	Continuous Drain Current, V_{GS} @ 10V	24	
I_{DM}	Pulsed Drain Current ①	160	
P_D @ $T_C = 25^\circ\text{C}$	Power Dissipation	570	W
	Linear Derating Factor	4.5	W/ $^\circ\text{C}$
V_{GS}	Gate-to-Source Voltage	± 30	V
dv/dt	Peak Diode Recovery dv/dt ③	7.5	V/ns
T_J	Operating Junction and Storage Temperature Range	-55 to + 150	°C
T_{STG}			

Avalanche Characteristics

Symbol	Parameter	Typ.	Max.	Units
E_{AS}	Single Pulse Avalanche Energy②	—	600	mJ
I_{AR}	Avalanche Current①	—	40	A
E_{AR}	Repetitive Avalanche Energy①	—	57	mJ

Thermal Resistance

Symbol	Parameter	Typ.	Max.	Units
$R_{\theta JC}$	Junction-to-Case④	—	0.22	°C/W
$R_{\theta CS}$	Case-to-Sink, Flat, Greased Surface	0.24	—	
$R_{\theta JA}$	Junction-to-Ambient④	—	40	

IRFPS40N60K

International
IR Rectifier

Static @ $T_J = 25^\circ\text{C}$ (unless otherwise specified)

Symbol	Parameter	Min.	Typ.	Max.	Units	Conditions
$V_{(BR)DSS}$	Drain-to-Source Breakdown Voltage	600	—	—	V	$V_{GS} = 0V, I_D = 250\mu A$
$\Delta V_{(BR)DSS}/\Delta T_J$	Breakdown Voltage Temp. Coefficient	—	0.63	—	V/ $^\circ\text{C}$	Reference to $25^\circ\text{C}, I_D = 1\text{mA}$ Ⓞ
$R_{DS(on)}$	Static Drain-to-Source On-Resistance	—	0.110	0.130	Ω	$V_{GS} = 10V, I_D = 24A$ Ⓞ
$V_{GS(th)}$	Gate Threshold Voltage	3.0	—	5.0	V	$V_{DS} = V_{GS}, I_D = 250\mu A$
I_{DSS}	Drain-to-Source Leakage Current	—	—	50	μA	$V_{DS} = 600V, V_{GS} = 0V$
		—	—	250		$V_{DS} = 480V, V_{GS} = 0V, T_J = 125^\circ\text{C}$
I_{GSS}	Gate-to-Source Forward Leakage	—	—	100	nA	$V_{GS} = 30V$
	Gate-to-Source Reverse Leakage	—	—	-100		$V_{GS} = -30V$

Dynamic @ $T_J = 25^\circ\text{C}$ (unless otherwise specified)

Symbol	Parameter	Min.	Typ.	Max.	Units	Conditions
g_{fs}	Forward Transconductance	21	—	—	S	$V_{DS} = 50V, I_D = 24A$
Q_g	Total Gate Charge	—	—	330	nC	$I_D = 38A$
Q_{gs}	Gate-to-Source Charge	—	—	84		$V_{DS} = 480V$
Q_{gd}	Gate-to-Drain ("Miller") Charge	—	—	150		$V_{GS} = 10V$, See Fig. 6 and 13 Ⓞ
$t_{d(on)}$	Turn-On Delay Time	—	47	—	ns	$V_{DD} = 300V$
t_r	Rise Time	—	110	—		$I_D = 38A$
$t_{d(off)}$	Turn-Off Delay Time	—	97	—		$R_G = 4.3\Omega$
t_f	Fall Time	—	60	—		$V_{GS} = 10V$, See Fig. 10 Ⓞ
C_{iss}	Input Capacitance	—	7970	—	pF	$V_{GS} = 0V$
C_{oss}	Output Capacitance	—	750	—		$V_{DS} = 25V$
C_{riss}	Reverse Transfer Capacitance	—	75	—		$f = 1.0\text{MHz}$, See Fig. 5
C_{oss}	Output Capacitance	—	9440	—		$V_{GS} = 0V, V_{DS} = 1.0V, f = 1.0\text{MHz}$
C_{oss}	Output Capacitance	—	200	—		$V_{GS} = 0V, V_{DS} = 480V, f = 1.0\text{MHz}$
$C_{oss \text{ eff.}}$	Effective Output Capacitance	—	260	—		$V_{GS} = 0V, V_{DS} = 0V \text{ to } 480V$ Ⓞ

Diode Characteristics

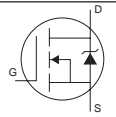
Symbol	Parameter	Min.	Typ.	Max.	Units	Conditions
I_S	Continuous Source Current (Body Diode)	—	—	40	A	MOSFET symbol showing the integral reverse p-n junction diode. 
I_{SM}	Pulsed Source Current (Body Diode) Ⓚ	—	—	160		
V_{SD}	Diode Forward Voltage	—	—	1.5	V	$T_J = 25^\circ\text{C}, I_S = 38A, V_{GS} = 0V$ Ⓞ
t_{rr}	Reverse Recovery Time	—	630	950	ns	$T_J = 25^\circ\text{C}$
		—	730	1090		$T_J = 125^\circ\text{C}$
Q_{rr}	Reverse Recovery Charge	—	14	20	μC	$T_J = 25^\circ\text{C}$
		—	17	25		$T_J = 125^\circ\text{C}$
I_{RRM}	Reverse Recovery Current	—	39	58	A	$T_J = 25^\circ\text{C}$
t_{on}	Forward Turn-On Time	Intrinsic turn-on time is negligible (turn-on is dominated by L_S+L_D)				

Notes:

- Ⓚ Repetitive rating; pulse width limited by max. junction temperature. (See Fig. 11)
- Ⓛ Starting $T_J = 25^\circ\text{C}$, $L = 0.84\text{mH}$, $R_G = 25\Omega$, $I_{AS} = 38A$, (See Figure 12a)
- Ⓜ $I_{SD} \leq 38A$, $di/dt \leq 224A/\mu\text{s}$, $V_{DD} \leq V_{(BR)DSS}$, $T_J \leq 150^\circ\text{C}$
- Ⓨ Pulse width $\leq 300\mu\text{s}$; duty cycle $\leq 2\%$.
- Ⓩ $C_{oss \text{ eff.}}$ is a fixed capacitance that gives the same charging time as C_{oss} while V_{DS} is rising from 0 to 80% V_{DSS}
- ⓐ R_θ is measured at T_J approximately 90°C

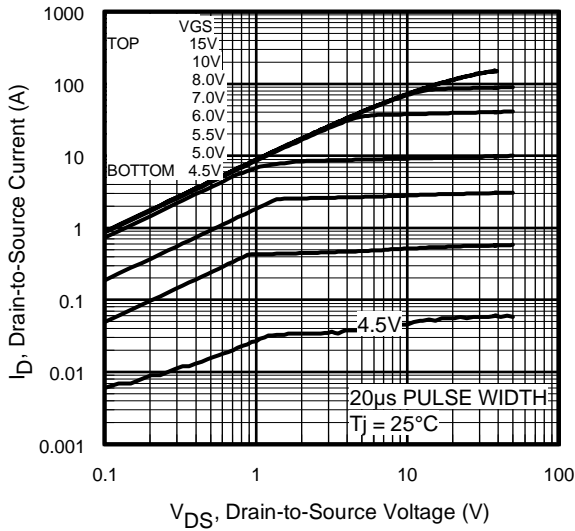

Fig 1. Typical Output Characteristics

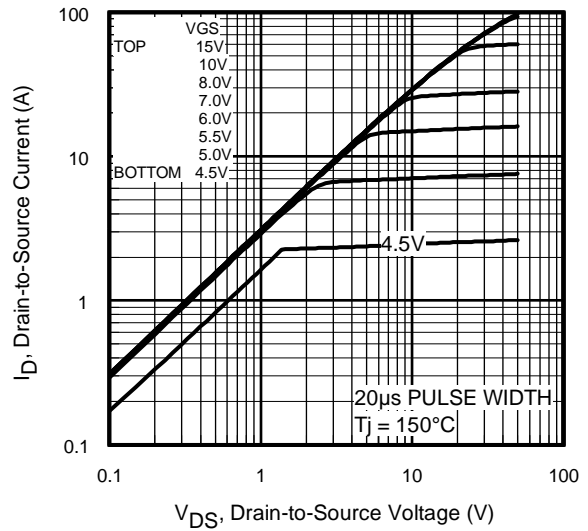

Fig 2. Typical Output Characteristics

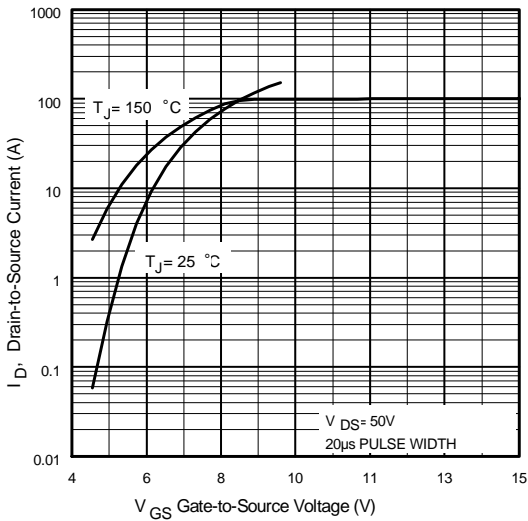

Fig 3. Typical Transfer Characteristics

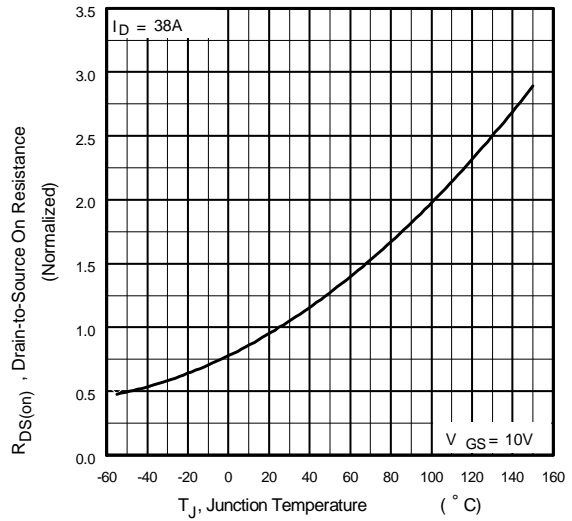

Fig 4. Normalized On-Resistance Vs. Temperature

IRFPS40N60K

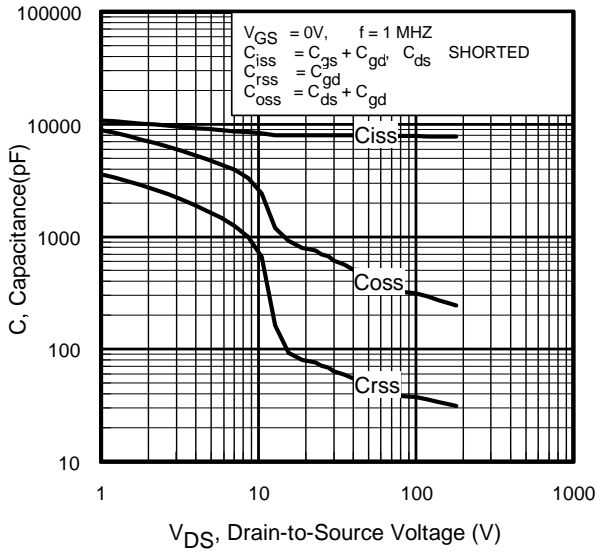

Fig 5. Typical Capacitance Vs. Drain-to-Source Voltage

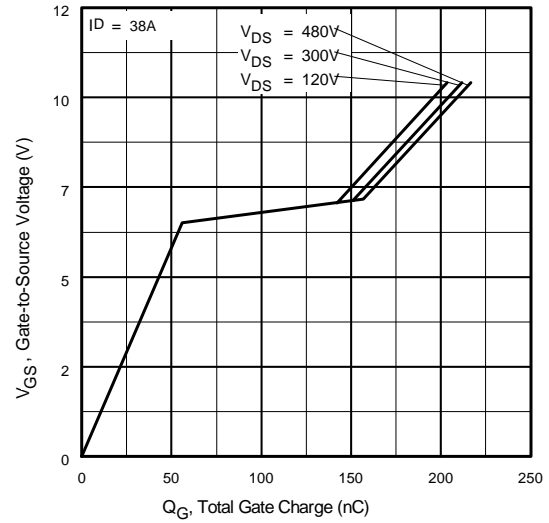

Fig 6. Typical Gate Charge Vs. Gate-to-Source Voltage

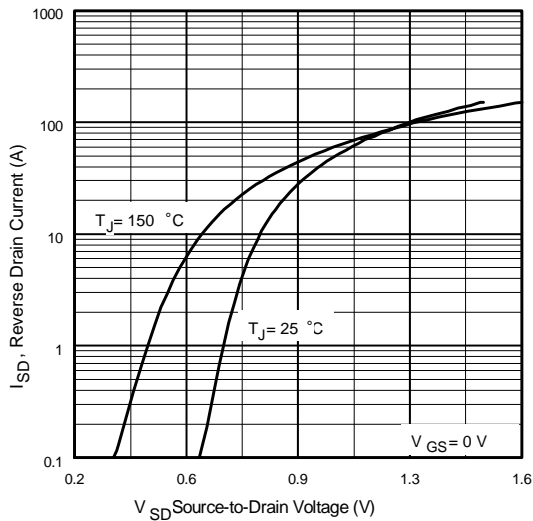

Fig 7. Typical Source-Drain Diode Forward Voltage

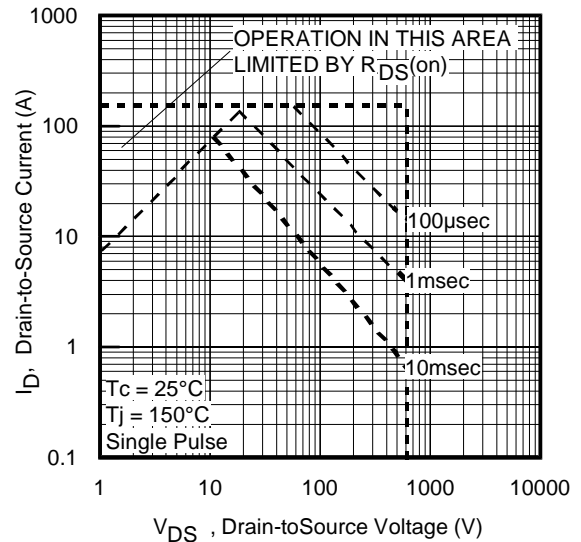

Fig 8. Maximum Safe Operating Area

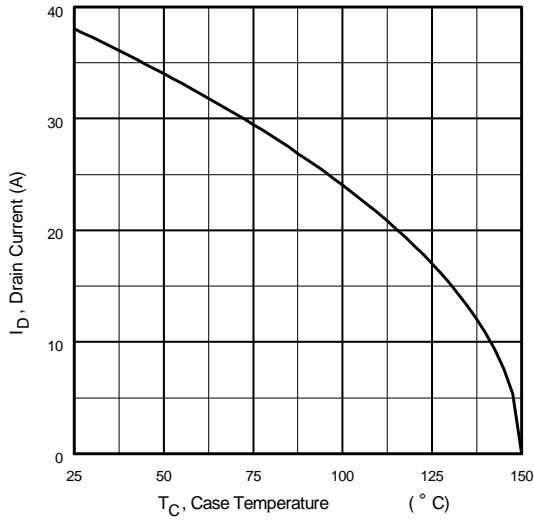

Fig 9. Maximum Drain Current Vs. Case Temperature



Fig 10a. Switching Time Test Circuit

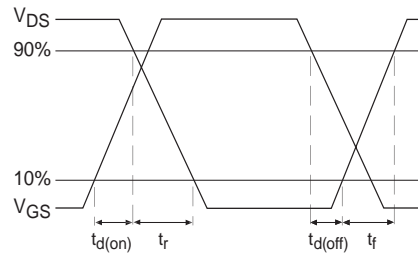

Fig 10b. Switching Time Waveforms

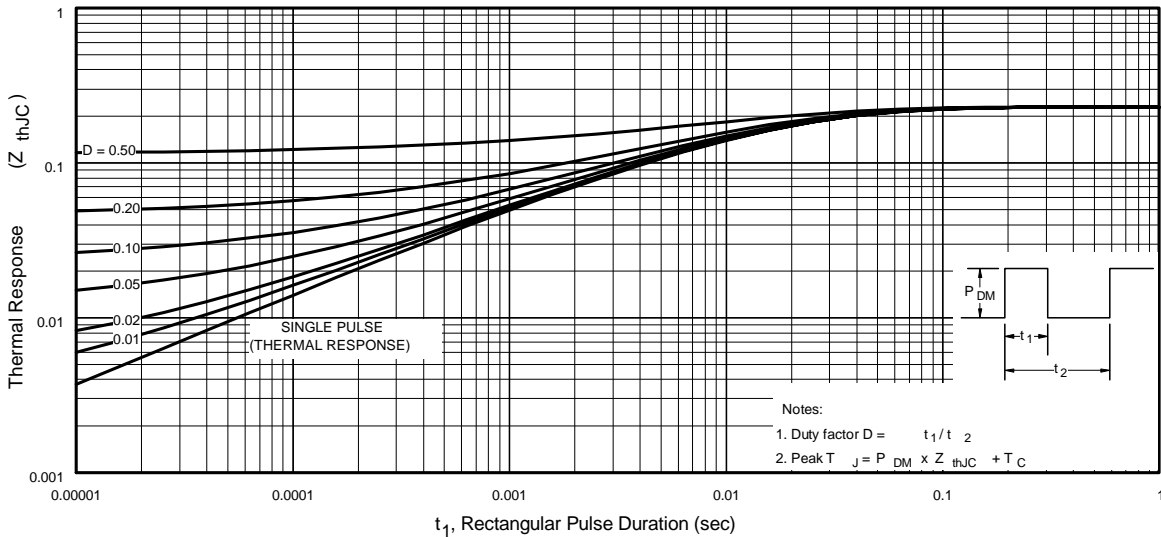

Fig 11. Maximum Effective Transient Thermal Impedance, Junction-to-Case

IRFPS40N60K

International
IR Rectifier

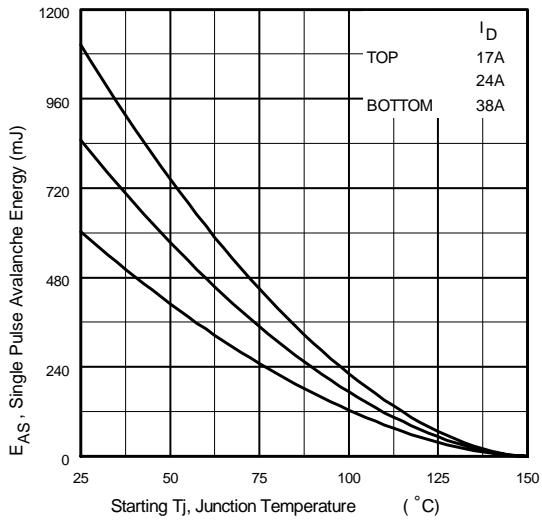

Fig 12a. Maximum Avalanche Energy Vs. Drain Current

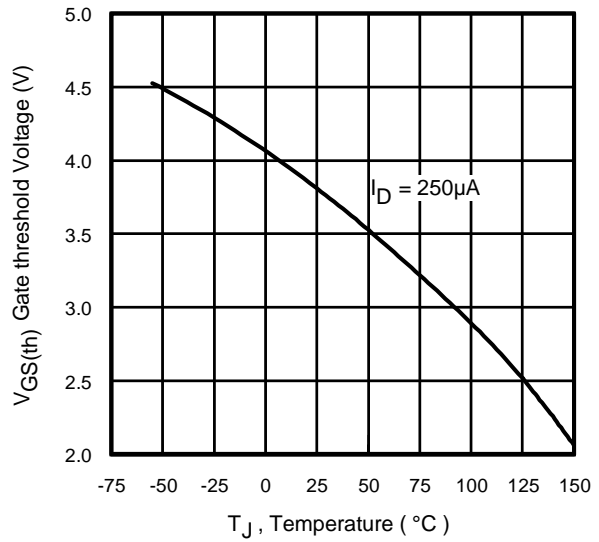

Fig 14. Threshold Voltage Vs. Temperature

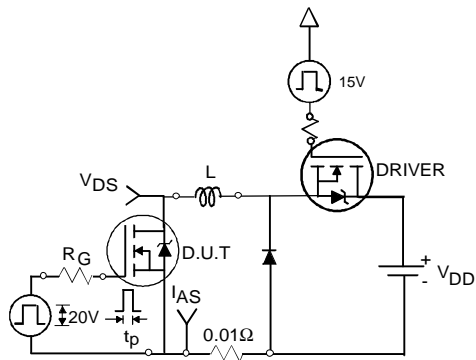

Fig 12b. Unclamped Inductive Test Circuit

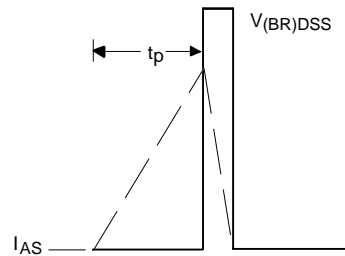

Fig 12c. Unclamped Inductive Waveforms

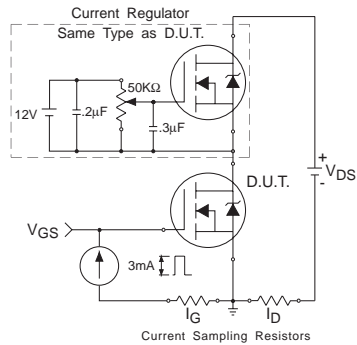

Fig 13a. Gate Charge Test Circuit

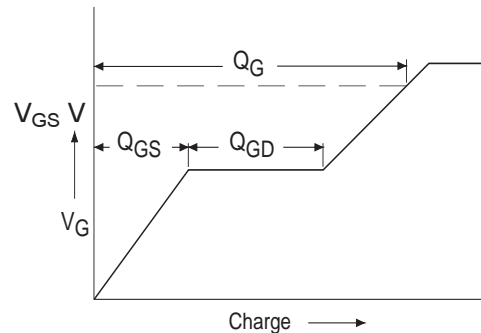
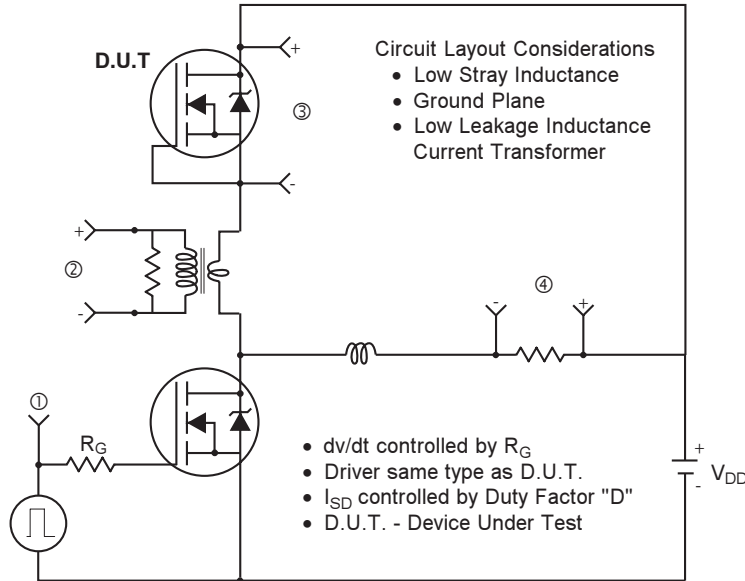

Fig 13b. Basic Gate Charge Waveform

www.irf.com

Peak Diode Recovery dv/dt Test Circuit



* $V_{GS} = 5V$ for Logic Level Devices

Fig 14. For N-Channel HEXFET® Power MOSFETs

IRFPS40N60K

International
IR Rectifier

SUPER TO-247AC Package Outline

Dimensions are shown in millimeters (inches)

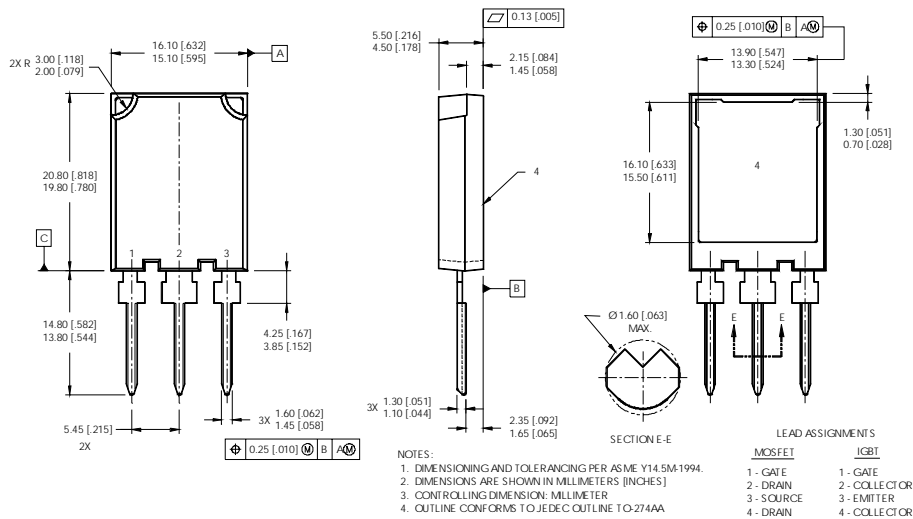

Super-247™ Part Marking Information

EXAMPLE: THIS IS AN IRFPS37N50A WITH
ASSEMBLY LOT CODE A8B9

INTERNATIONAL RECTIFIER
LOGO

ASSEMBLY LOT CODE

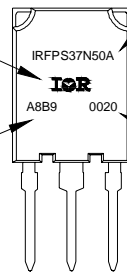

TOP

PART NUMBER

DATE CODE
(YYWW)
YY = YEAR
WW = WEEK

Data and specifications subject to change without notice.
This product has been designed and qualified for the Industrial market.
Qualification Standards can be found on IR's Web site.

International
IR Rectifier

IR WORLD HEADQUARTERS: 233 Kansas St., El Segundo, California 90245, USA Tel: (310) 252-7105
TAC Fax: (310) 252-7903

Visit us at www.irf.com for sales contact information.10/04

www.irf.com