



## MOSMIC<sup>®</sup> for TV-Tuner Prestage with 5 V Supply Voltage

MOSMIC - MOS Monolithic Integrated Circuit

Electrostatic sensitive device.  
Observe precautions for handling.



### Applications

Low noise gain controlled input stages in UHF-and VHF- tuner with 5 V supply voltage.

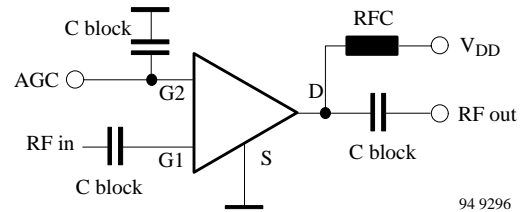

### Features

- Integrated gate protection diodes
- Low noise figure
- High gain
- Biasing network on chip
- Improved cross modulation at gain reduction
- High AGC-range
- SMD package

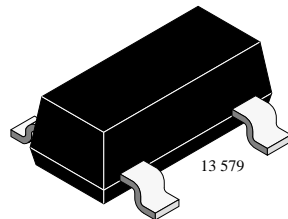
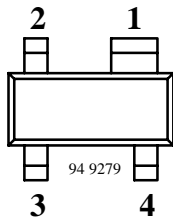

S595T Marking: 595  
Plastic case (SOT 143)  
1 = Source, 2 = Drain, 3 = Gate 2, 4 = Gate 1

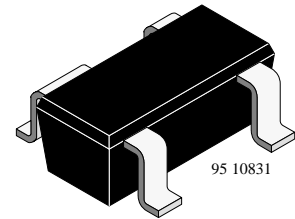
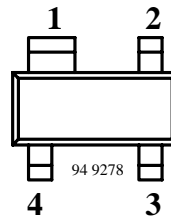

S595TR Marking: 59R  
Plastic case (SOT 143R)  
1 = Source, 2 = Drain, 3 = Gate 2, 4 = Gate 1

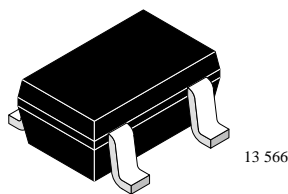
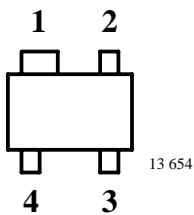

S595TRW Marking: W59  
Plastic case (SOT 343R)  
1 = Source, 2 = Drain, 3 = Gate 2, 4 = Gate 1

### Absolute Maximum Ratings

$T_{amb} = 25^{\circ}\text{C}$ , unless otherwise specified

Parameter	Test Conditions	Symbol	Value	Unit
Drain - source voltage		$V_{DS}$	8	V
Drain current		$I_D$	30	mA
Gate 1/Gate 2 - source peak current		$\pm I_{G1/G2SM}$	10	mA
Gate 1/Gate 2 - source voltage		$\pm V_{G1/G2SM}$	6	V
Total power dissipation	$T_{amb} \leq 60^{\circ}\text{C}$	$P_{tot}$	200	mW
Channel temperature		$T_{Ch}$	150	$^{\circ}\text{C}$
Storage temperature range		$T_{stg}$	-55 to +150	$^{\circ}\text{C}$

### Maximum Thermal Resistance

$T_{amb} = 25^{\circ}\text{C}$ , unless otherwise specified

Parameter	Test Conditions	Symbol	Value	Unit
Channel ambient	on glass fibre printed board (25 x 20 x 1.5) mm <sup>3</sup> plated with 35 $\mu\text{m}$ Cu	$R_{thChA}$	450	K/W

### Electrical DC Characteristics

$T_{amb} = 25^{\circ}\text{C}$ , unless otherwise specified

Parameter	Test Conditions	Symbol	Min	Typ	Max	Unit
Gate 1 - source breakdown voltage	$\pm I_{G1S} = 10\text{ mA}$ , $V_{G2S} = V_{DS} = 0$	$\pm V_{(BR)G1SS}$	7		10	V
Gate 2 - source breakdown voltage	$\pm I_{G2S} = 10\text{ mA}$ , $V_{G1S} = V_{DS} = 0$	$\pm V_{(BR)G2SS}$	7		10	V
Gate 1 - source leakage current	$+V_{G1S} = 5\text{ V}$ , $V_{G2S} = V_{DS} = 0$	$+I_{G1SS}$			50	$\mu\text{A}$
	$-V_{G1S} = 5\text{ V}$ , $V_{G2S} = V_{DS} = 0$	$-I_{G1SS}$			100	$\mu\text{A}$
Gate 2 - source leakage current	$\pm V_{G2S} = 5\text{ V}$ , $V_{G1S} = V_{DS} = 0$	$\pm I_{G2SS}$			20	nA
Drain current	$V_{DS} = 5\text{ V}$ , $V_{G1S} = 0$ , $V_{G2S} = 4\text{ V}$	$I_{DSS}$	50		500	$\mu\text{A}$
Self-biased operating current	$V_{DS} = 5\text{ V}$ , $V_{G1S} = \text{nc}$ , $V_{G2S} = 4\text{ V}$	$I_{DSP}$	9	13	18	mA
Gate 2 - source cut-off voltage	$V_{DS} = 5\text{ V}$ , $V_{G1S} = \text{nc}$ , $I_D = 20\text{ }\mu\text{A}$	$V_{G2S(OFF)}$		1.0		V

### Caution for Gate 1 switch-off mode:

No external DC-voltage on Gate 1 in active mode!

Switch-off at Gate 1 with  $V_{G1S} < 0.7\text{ V}$  is feasible.

Using open collector switching transistor (inside of PLL), insert 10 k $\Omega$  collector resistor.



**Electrical AC Characteristics**

$V_{DS} = 5\text{ V}$ ,  $V_{G2S} = 4\text{ V}$ ,  $f = 1\text{ MHz}$ ,  $T_{amb} = 25^\circ\text{C}$ , unless otherwise specified

Parameter	Test Conditions	Symbol	Min	Typ	Max	Unit
Forward transadmittance		$ Y_{21s} $	28	30	35	mS
Gate 1 input capacitance		$C_{issg1}$		2.3	2.7	pF
Feedback capacitance		$C_{rss}$		25		fF
Output capacitance		$C_{oss}$		1.1		pF
Power gain	$G_S = 2\text{ mS}$ , $G_L = 0.5\text{ mS}$ , $f = 200\text{ MHz}$	$G_{ps}$		28		dB
	$G_S = 3,3\text{ mS}$ , $G_L = 1\text{ mS}$ , $f = 800\text{ MHz}$	$G_{ps}$	17	21		dB
AGC range	$V_{DS} = 5\text{ V}$ , $V_{G2S} = 1\text{ to }4\text{ V}$ , $f = 800\text{ MHz}$	$\Delta G_{ps}$	45			dB
Noise figure	$G_S = 2\text{ mS}$ , $G_L = 0.5\text{ mS}$ , $f = 200\text{ MHz}$	F		1		dB
	$G_S = 3,3\text{ mS}$ , $G_L = 1\text{ mS}$ , $f = 800\text{ MHz}$	F		1.3		dB

**Common Source S-Parameters**

$V_{DS} = 5\text{ V}$ ,  $V_{G2S} = 4\text{ V}$ ,  $Z_0 = 50\ \Omega$ ,  $T_{amb} = 25^\circ\text{C}$ , unless otherwise specified

f/MHz	S11		S21		S12		S22	
	LOG MAG	ANG	LOG MAG	ANG	LOG MAG	ANG	LOG MAG	ANG
	dB	deg	dB	deg	dB	deg	dB	deg
50	-0.01	-4.6	9.61	174.3	-63.13	88.0	-0.08	-2.1
100	-0.03	-9.2	9.56	167.9	-56.88	85.3	-0.10	-4.3
150	-0.11	-13.8	9.44	161.3	-53.46	82.8	-0.14	-6.4
200	-0.19	-18.1	9.30	155.1	-51.38	80.7	-0.16	-8.6
250	-0.28	-22.6	9.15	148.4	-49.76	78.3	-0.22	-11.0
300	-0.40	-26.8	9.00	142.7	-48.70	77.3	-0.26	-12.9
350	-0.51	-31.1	8.79	136.8	-47.92	76.4	-0.30	-15.1
400	-0.64	-35.2	8.62	130.7	-47.45	76.2	-0.38	-17.1
450	-0.78	-39.3	8.35	125.3	-47.23	76.7	-0.43	-18.8
500	-0.93	-43.2	8.17	119.7	-47.10	78.4	-0.49	-20.6
550	-1.07	-47.1	7.94	114.2	-47.22	82.3	-0.55	-22.6
600	-1.22	-50.8	7.71	108.7	-46.92	88.6	-0.60	-24.6
650	-1.36	-54.4	7.50	104.1	-46.68	92.6	-0.66	-26.1
700	-1.49	-58.2	7.26	99.1	-46.47	98.8	-0.70	-27.9
750	-1.65	-61.5	7.08	94.1	-46.45	107.2	-0.73	-29.8
800	-1.79	-65.2	6.86	89.2	-45.89	116.7	-0.78	-31.7
850	-1.94	-68.6	6.68	84.5	-44.77	125.9	-0.80	-33.4
900	-2.04	-72.0	6.44	79.3	-43.51	133.0	-0.85	-35.4
950	-2.17	-75.3	6.27	74.4	-41.91	137.1	-0.87	-37.2
1000	-2.29	-78.7	6.09	70.4	-40.66	138.5	-0.89	-39.1
1050	-2.42	-82.2	5.93	65.8	-39.81	140.6	-0.90	-41.1
1100	-2.58	-85.2	5.67	61.1	-38.89	143.6	-0.92	-42.6
1150	-2.70	-88.4	5.55	56.1	-37.91	145.8	-0.93	-44.6
1200	-2.78	-91.6	5.41	51.8	-36.76	148.3	-0.94	-46.7
1250	-2.89	-94.8	5.38	47.1	-35.65	149.7	-0.93	-49.1
1300	-3.00	-97.7	5.17	42.0	-34.63	150.1	-0.92	-51.0

## Typical Characteristics ( $T_{amb} = 25^{\circ}\text{C}$ unless otherwise specified)

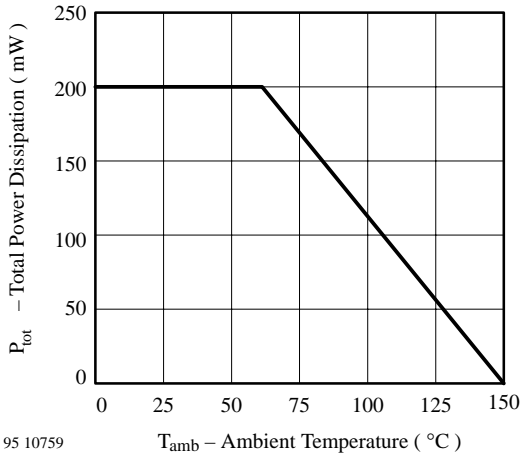

Figure 1. Total Power Dissipation vs. Ambient Temperature

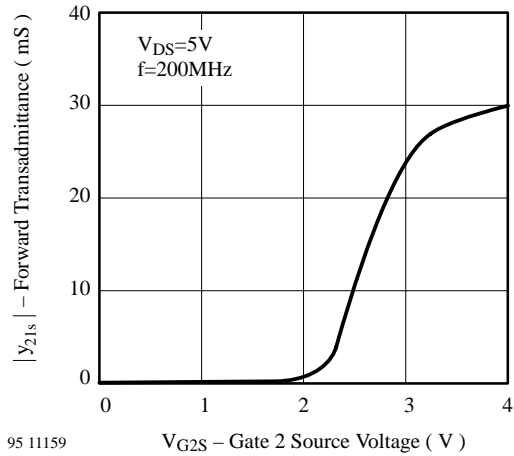

Figure 4. Forward Transadmittance vs. Gate 2 Source Voltage

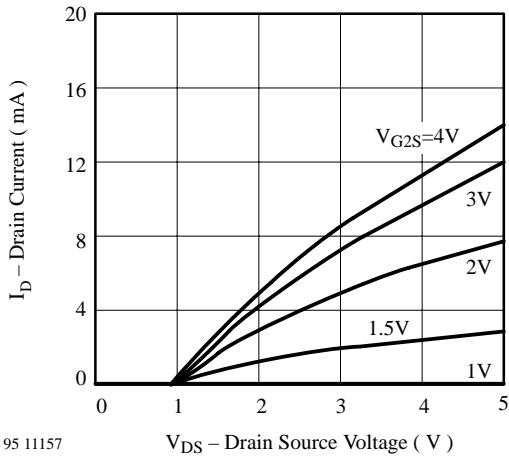

Figure 2. Drain Current vs. Drain Source Voltage

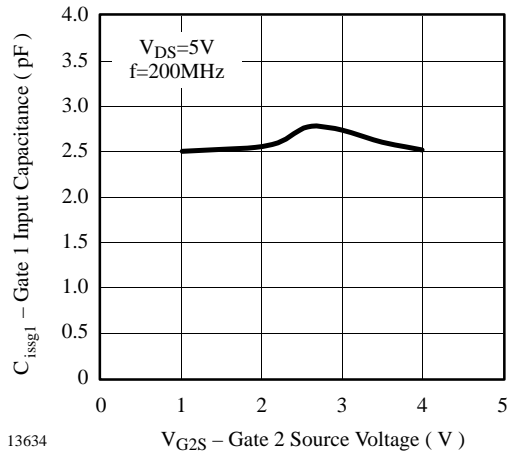

Figure 5. Gate 1 Input Capacitance vs. Gate 2 Source Voltage

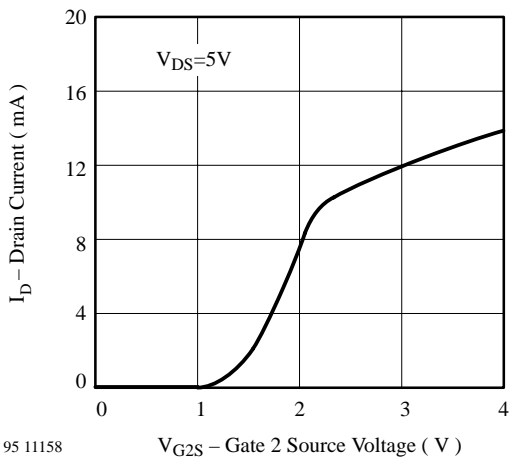

Figure 3. Drain Current vs. Gate 2 Source Voltage

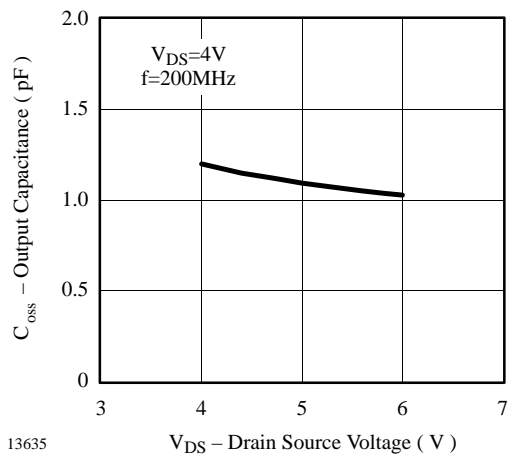
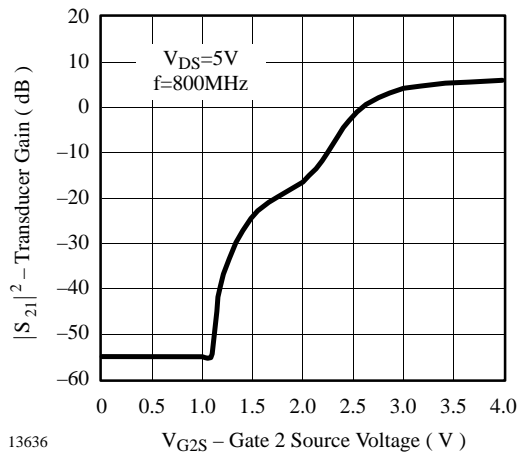
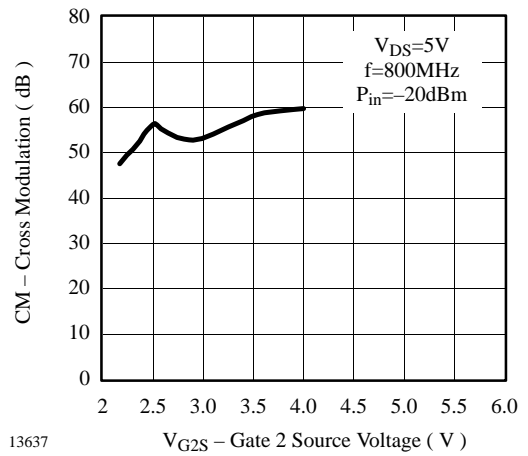

Figure 6. Output Capacitance vs. Drain Source Voltage



13636

Figure 7. Transducer Gain vs. Gate 2 Source Voltage



13637

Figure 8. Cross Modulation vs. Gate 2 Source Voltage

$V_{DS} = 5\text{ V}$ ,  $V_{G2S} = 4\text{ V}$ ,  $Z_0 = 50\ \Omega$

$S_{11}$

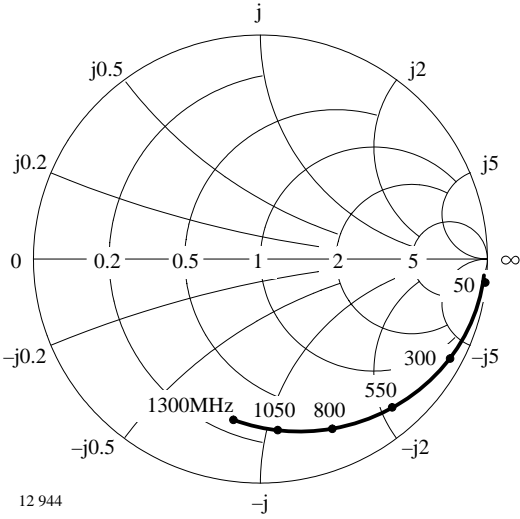

Figure 9. Input reflection coefficient

$S_{12}$

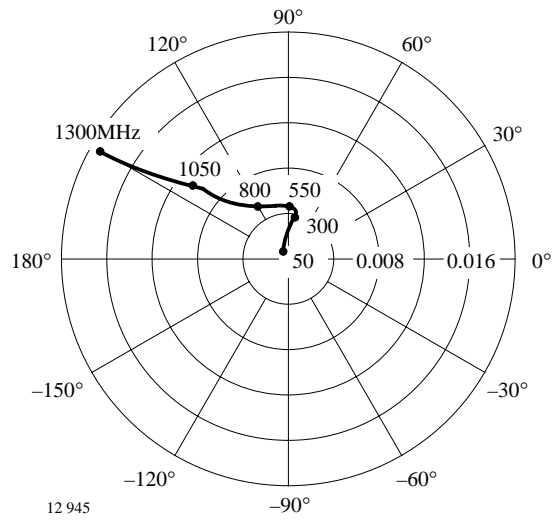

Figure 11. Reverse transmission coefficient

$S_{21}$

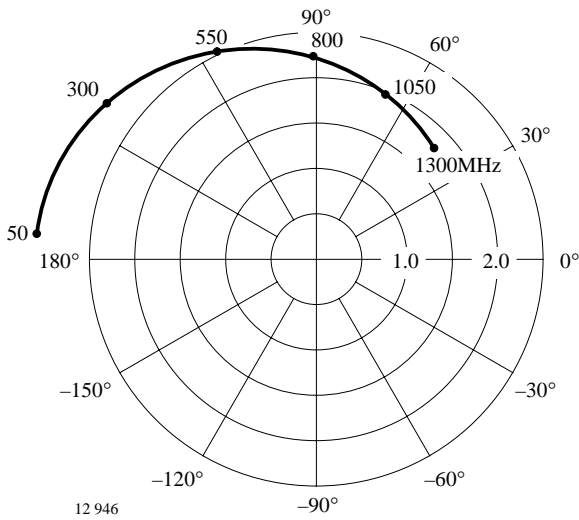

Figure 10. Forward transmission coefficient

$S_{22}$

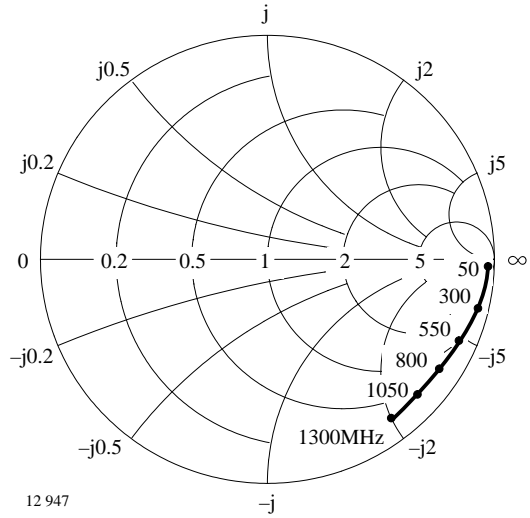
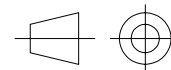
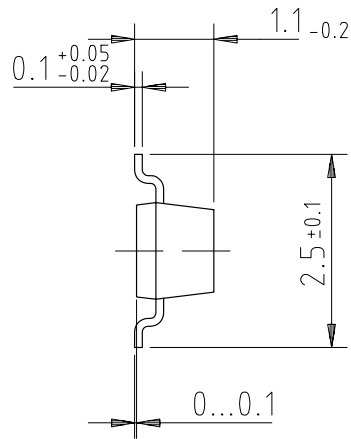
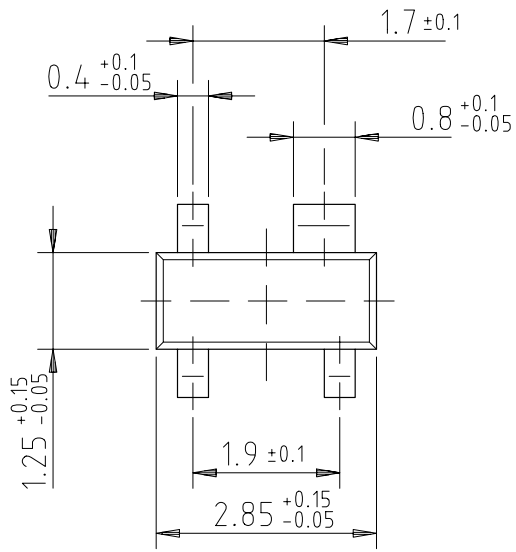

Figure 12. Output reflection coefficient

## Dimensions of S595T in mm



96 12240

technical drawings  
according to DIN  
specifications

## Dimensions of S595TR in mm

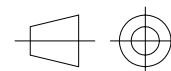
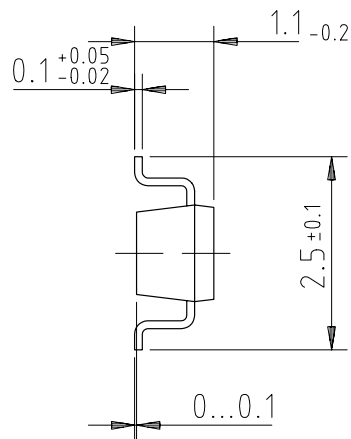
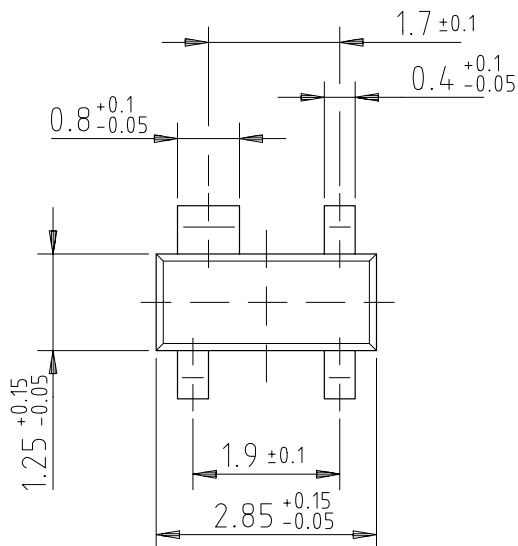

96 12239

technical drawings  
according to DIN  
specifications

### Dimensions of S595TRW in mm

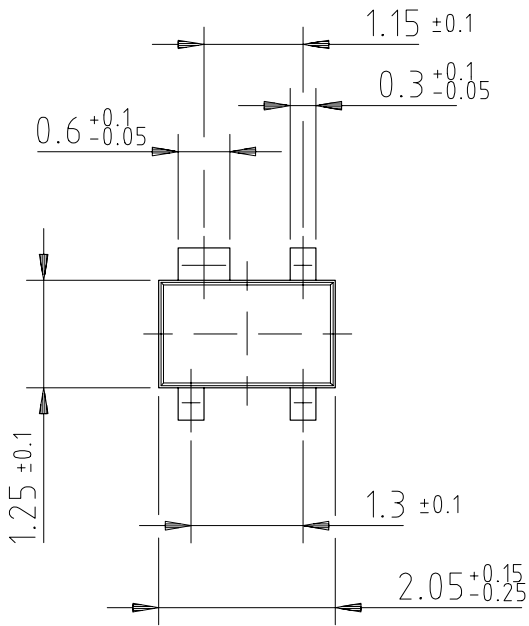

96 12238

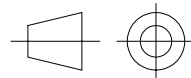

technical drawings  
according to DIN  
specifications





## **Ozone Depleting Substances Policy Statement**

It is the policy of **Vishay Semiconductor GmbH** to

1. Meet all present and future national and international statutory requirements.
2. Regularly and continuously improve the performance of our products, processes, distribution and operating systems with respect to their impact on the health and safety of our employees and the public, as well as their impact on the environment.

It is particular concern to control or eliminate releases of those substances into the atmosphere which are known as ozone depleting substances (ODSs).

The Montreal Protocol (1987) and its London Amendments (1990) intend to severely restrict the use of ODSs and forbid their use within the next ten years. Various national and international initiatives are pressing for an earlier ban on these substances.

**Vishay Semiconductor GmbH** has been able to use its policy of continuous improvements to eliminate the use of ODSs listed in the following documents.

1. Annex A, B and list of transitional substances of the Montreal Protocol and the London Amendments respectively
2. Class I and II ozone depleting substances in the Clean Air Act Amendments of 1990 by the Environmental Protection Agency (EPA) in the USA
3. Council Decision 88/540/EEC and 91/690/EEC Annex A, B and C (transitional substances) respectively.

**Vishay Semiconductor GmbH** can certify that our semiconductors are not manufactured with ozone depleting substances and do not contain such substances.

**We reserve the right to make changes to improve technical design and may do so without further notice.**

Parameters can vary in different applications. All operating parameters must be validated for each customer application by the customer. Should the buyer use Vishay-Telefunken products for any unintended or unauthorized application, the buyer shall indemnify Vishay-Telefunken against all claims, costs, damages, and expenses, arising out of, directly or indirectly, any claim of personal damage, injury or death associated with such unintended or unauthorized use.

Vishay Semiconductor GmbH, P.O.B. 3535, D-74025 Heilbronn, Germany  
Telephone: 49 (0) 7131 67 2831, Fax number: 49 (0) 7131 67 2423