

**SANYO**

No.3042

**LC7821N,7822N,7823N**

CMOS LSI

Analog Function Switch

**Use**

- Serial data-controlled function select switch suited for use in amplifiers, receivers.

**Features**

- Analog switches of 8 channels × 2 (LC7823N : 7 channels × 2) are contained. Three types are available according to the internal connection.
- Control is exercised by serial data. The LC7821N,7822N,7823N may be interfaced with a microcomputer (5V supply) easily.
- Even if two ICs of the same type are used, they may be connected to the common bus line because the S (selector) pin is provided.
- Reset pin used to turn OFF all analog switches
- Wide dynamic range because of ±20V breakdown voltage

**Absolute Maximum Ratings at Ta = 25°C**

Parameter	Symbol	Value	Unit
Maximum Supply Voltage	V <sub>DD</sub> max	V <sub>DD</sub> -0.3 to +20	V
	V <sub>EE</sub> max	V <sub>EE</sub> -20 to +0.3	V
Maximum Input Voltage	V <sub>I1</sub>	D1, CL, CE, S, RES	-0.3 to +20 V
	V <sub>I2</sub>	L1 to L8, R1 to R8, LCOM1 to LCOM4, RCOM1 to RCOM4	V <sub>EE</sub> -0.3 to V <sub>DD</sub> +0.3 V
Analog Switch ON-State Voltage Difference	ΔV <sub>ON</sub>	Switch ON	0.5 V
Allowable Power Dissipation	P <sub>d</sub> max	Ta ≤ 75°C	100 mW
Operating Temperature	T <sub>opg</sub>		-30 to +75 °C
Storage Temperature	T <sub>stg</sub>		-40 to +125 °C

**Pin Assignment**

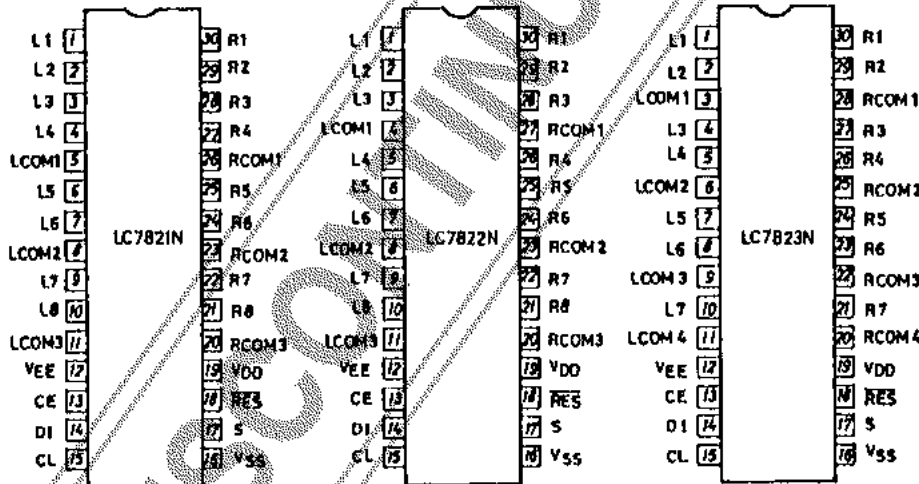

Case Outline 3047A-D30SIC (unit: mm)

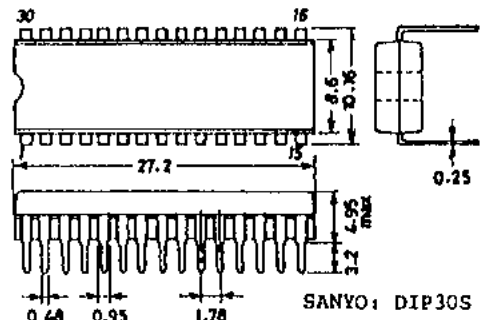

The application circuit diagrams and circuit constants herein are included as an example and provide no guarantee for designing equipment to be mass-produced. The information herein is believed to be accurate and reliable. However, no responsibility is assumed by SANYO for its use; nor for any infringements of patents or other rights of third parties which may result from its use.

Specifications and information herein are subject to change without notice.

**SANYO Electric Co., Ltd. Semiconductor Overseas Marketing Div.**  
 Natsume Bldg., 18-6, 2 chome, Yushima, Bunkyo-ku, TOKYO 113 JAPAN

2109YT, TS No.3042-1/6

LC7821N,7822N,7823N

Allowable Operating Conditions at $T_a = 25^\circ\text{C}, V_{SS} = 0\text{V},  V_{DD}  \geq  V_{EE} $			min	typ	max	unit
Maximum Supply Voltage	$V_{DD}$	$V_{DD} - V_{EE} \geq 12\text{V} : V_{DD}$	6.0		18.5	V
	$V_{EE}$	$V_{DD} - V_{EE} \geq 12\text{V} : V_{EE}$	-18.5		0	V
Input "H"-Level Voltage	$V_{IH1}$	DI, CL, CE, S	4.0		18.5	V
	$V_{IH2}$	RES	$0.7V_{DD}$		$V_{DD}$	V
Input "L"-Level Voltage	$V_{IL1}$	DI, CL, CE, S	0		0.7	V
	$V_{IL2}$	RES	0	$0.3V_{DD}$		V
(Analog Switch Input Voltage Range	$V_{IN}$	L1 to L8, R1 to R8, LCOM1 to LCOM4, RCOM1 to RCOM4	$V_{EE}$		$V_{DD}$	V
"L"-Level Clock Pulse Width	$t_{\phi L}$	CL	0.5			$\mu\text{sec}$
"H"-Level Clock Pulse Width	$t_{\phi H}$	CL	0.5			$\mu\text{sec}$
Setup Time	$t_{\text{setup}}$	CL, DI	0.5			$\mu\text{sec}$
	$t_1^*$	CL, CE	0.5			$\mu\text{sec}$
	$t_2^*$	CL, CE	0.5			$\mu\text{sec}$
	$t_3^*$	CL, CE	0.5			$\mu\text{sec}$
	Reset Minimum Pulse Width	$t_{wRES}$	$V_{DD} \geq 6\text{V} : \overline{\text{RES}}$	1.0		
Hysteresis Width	$V_{H1}$	CL, CE, DI	0.3			V

\* : CE, CL, DI waveforms

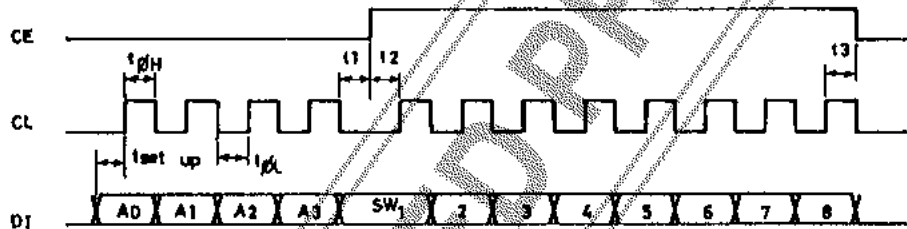

Electrical Characteristics at $T_a = 25^\circ\text{C}, V_{SS} = 0\text{V}$			min	typ	max	unit
Analog Switch ON-State Resistance	$R_{ON1}$	$I = 1\text{mA}, V_{DD} - V_{EE} = 12\text{V} : \text{L1 to L8, R1 to R8, LCOM1 to LCOM4, RCOM1 to RCOM4}$		150		$\Omega$
	$R_{ON2}$	$I = 1\text{mA}, V_{DD} - V_{EE} = 37\text{V} : \text{L1 to L8, R1 to R8, LCOM1 to LCOM4, RCOM1 to RCOM4}$		70		$\Omega$
Total Harmonic Distortion	THD1	$V_{IN} = 1\text{V}_{\text{rms}}, f = 1\text{kHz}, V_{DD} - V_{EE} = 37\text{V} : \text{L1 to L8, R1 to R8, LCOM1 to LCOM4, RCOM1 to RCOM4}$		0.0015	0.01	%
	THD2	$V_{IN} = 0.1\text{V}_{\text{rms}}, f = 1\text{kHz}, V_{DD} - V_{EE} = 37\text{V} : \text{L1 to L8, R1 to R8, LCOM1 to LCOM4, RCOM1 to RCOM4}$		0.01	0.05	%
Feedthrough	$F_{TH}$	$V_{IN} = 0\text{dBV}, f = 10\text{kHz}, V_{DD} - V_{EE} = 37\text{V} : \text{L1 to L8, R1 to R8, LCOM1 to LCOM4, RCOM1 to RCOM4}$		65		dB
Crosstalk	CT	$V_{IN} = 0\text{dBV}, f = 10\text{kHz}, V_{DD} - V_{EE} = 37\text{V} : \text{L1 to L8, R1 to R8, LCOM1 to LCOM4, RCOM1 to RCOM4}$		75		dB
Input "H"-Level Current	$I_{IH}$	$V_I = 18.5\text{V} : \text{DI, CL, CE, S, RES}$			10	$\mu\text{A}$
Input "L"-Level Current	$I_{IL}$	$V_I = 0\text{V} : \text{DI, CL, CE, S, RES}$	-10			$\mu\text{A}$
(Analog Switch OFF-State Leakage Current	$I_{OFF}$	$V_I = V_{EE} \text{ to } V_{EE} + 37\text{V} : \text{L1 to L8, R1 to R8, LCOM1 to LCOM4, RCOM1 to RCOM4}$	-10		10	$\mu\text{A}$
Current Dissipation	$I_{DD}$	$V_{DD}$			1.0	mA

# LC7821N,7822N,7823N

## Equivalent Circuit Block Diagram

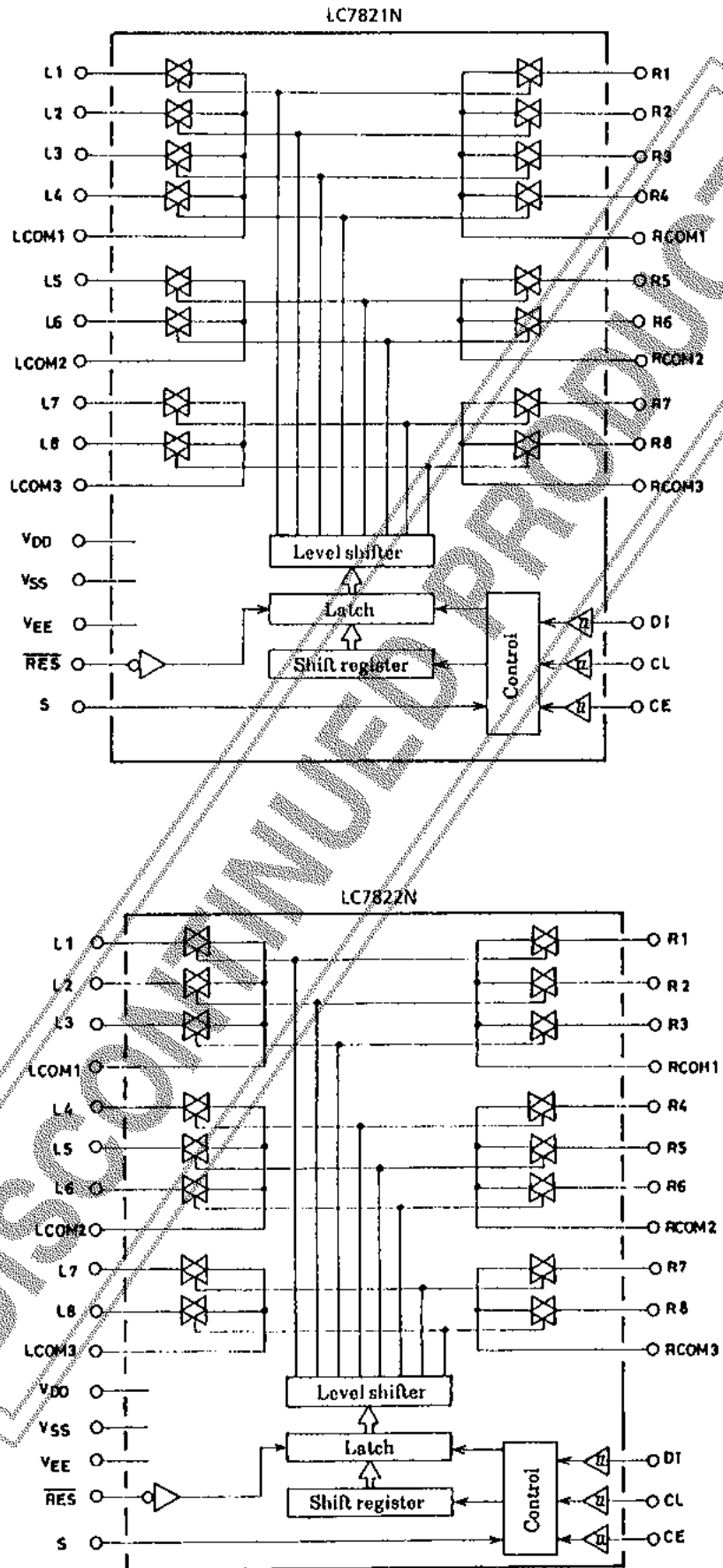

LC7821N,7822N,7823N

Equivalent Circuit Block Diagram

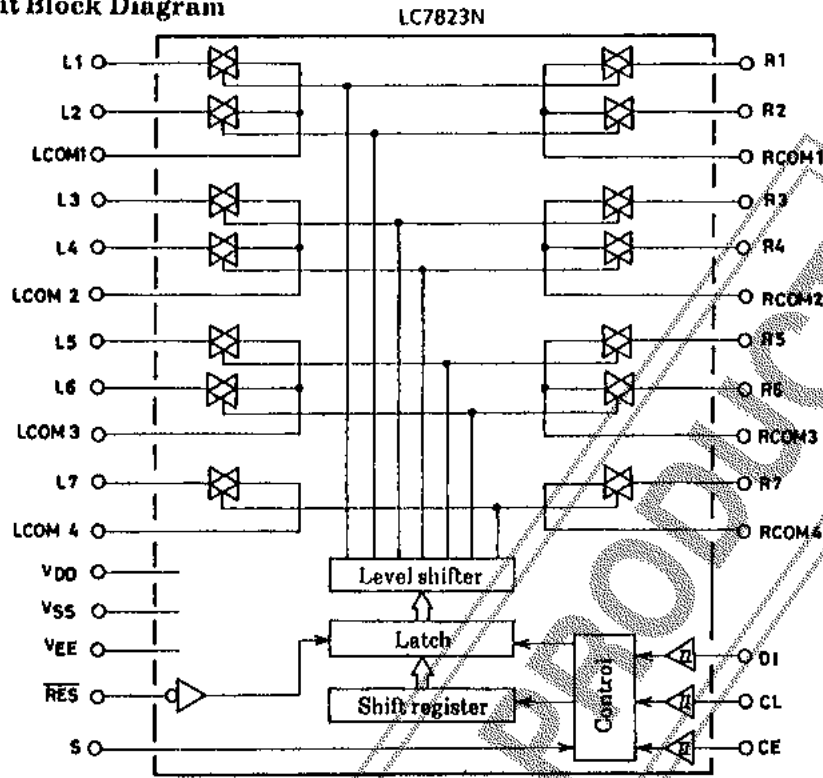

Pin Description

Pin Name	I/O	Internal Equivalent Circuit	Function																																											
V <sub>DD</sub> , V <sub>SS</sub> , V <sub>EE</sub>			Power supply pins																																											
L1 to L8, R1 to R8, LCOM1 to LCOM4, RCOM1 to RCOM4		See Block Diagram.	Input/output pins for analog switches.																																											
CL, DI, CE	I		Serial data input pins (Schmitt buffer) CL---Clock input pin DI---Data input pin CE---Chip enable pin																																											
S	I		Select pin in the two ICs-used mode When the S pin is brought to "L" or "H" level, the address will become as shown below. <table border="1" data-bbox="986 1630 1385 1904"> <thead> <tr> <th rowspan="2">Type No.</th> <th rowspan="2">S Pin</th> <th colspan="4">Address</th> </tr> <tr> <th>A0</th> <th>A1</th> <th>A2</th> <th>A3</th> </tr> </thead> <tbody> <tr> <td rowspan="2">LC7821N</td> <td>L</td> <td>0</td> <td>1</td> <td>0</td> <td>1</td> </tr> <tr> <td>H</td> <td>1</td> <td>1</td> <td>0</td> <td>1</td> </tr> <tr> <td rowspan="2">LC7822N</td> <td>L</td> <td>0</td> <td>0</td> <td>1</td> <td>1</td> </tr> <tr> <td>H</td> <td>1</td> <td>0</td> <td>1</td> <td>1</td> </tr> <tr> <td rowspan="2">LC7823N</td> <td>L</td> <td>0</td> <td>1</td> <td>1</td> <td>1</td> </tr> <tr> <td>H</td> <td>1</td> <td>1</td> <td>1</td> <td>1</td> </tr> </tbody> </table>	Type No.	S Pin	Address				A0	A1	A2	A3	LC7821N	L	0	1	0	1	H	1	1	0	1	LC7822N	L	0	0	1	1	H	1	0	1	1	LC7823N	L	0	1	1	1	H	1	1	1	1
Type No.	S Pin	Address																																												
		A0	A1	A2	A3																																									
LC7821N	L	0	1	0	1																																									
	H	1	1	0	1																																									
LC7822N	L	0	0	1	1																																									
	H	1	0	1	1																																									
LC7823N	L	0	1	1	1																																									
	H	1	1	1	1																																									
$\overline{\text{RES}}$	I		Reset pin When power is applied, the state of the analog switches will be indeterminate. When this pin is brought to "L" level, all analog switches will be turned OFF.																																											

# LC7821N,7822N,7823N

## Operation Description

### 1. Data input method

The LC7821N,7822N,7823N are controlled by inputting serial data to the CI, DI, CE pins. Data consists of 12bits in all (address : 4 bits, data : 8 bits).

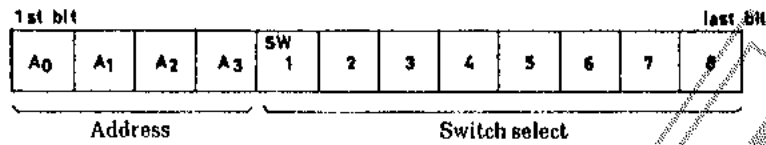

Each switch No. corresponds to analog switches L1 to L8, R1 to R8.  
Set the bit of a switch to be turned ON to 1.

0 ----- OFF  
1 ----- ON

The address is used for chip select when connected to the common bus line.  
When the S pin is brought to "L" or "H" level, the transmit data will become as shown below.

Type No.	S Pin	Address			
		A0	A1	A2	A3
LC7821N	L	0	1	0	1
	H	1	1	0	1
LC7822N	L	0	0	1	1
	H	1	0	1	1
LC7823N	L	0	1	1	1
	H	1	1	1	1

Note : For the LC7823N, the bit of switch 8 becomes "don't care" (0 or 1).  
The reason for this is that the LC7823N contains 7 channels × 2 of analog switches.

### 2. Timing of DI,CI,CE pulse signals

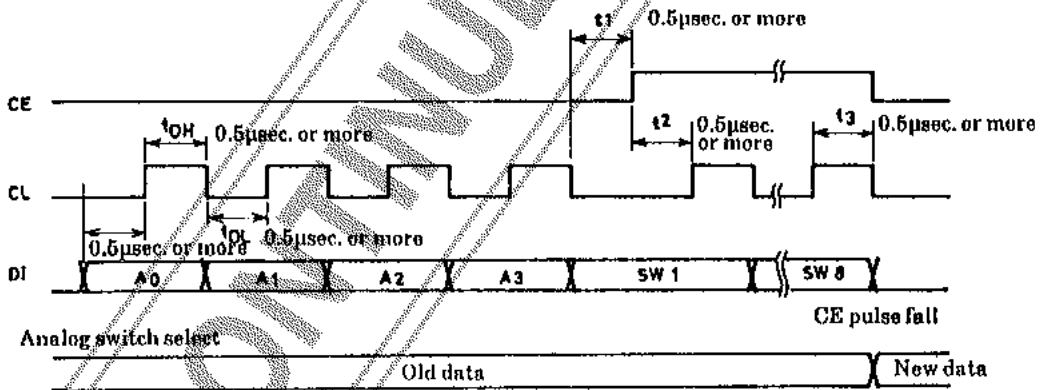

Data is fetched into the inside on the positive transition of the CL pulse and latched on the negative transition of the CE pulse.

### 3. Reset pin

When power is applied, the state of the analog switches will be indeterminate. All analog switches may be turned OFF by connecting C, R to this pin externally.

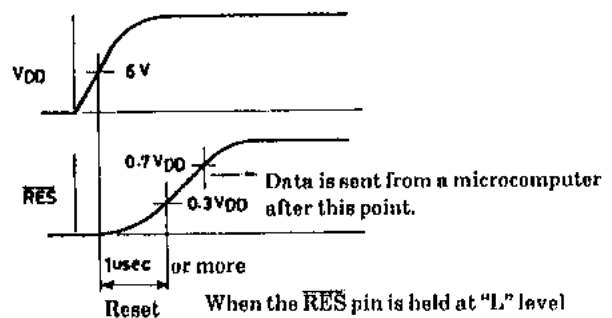
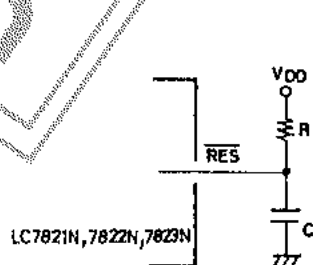

When the RES pin is held at "L" level for 1µsec. or more, all analog switches will be turned OFF.

- When the C<sup>2</sup>B is shared by plural ICs :  
The state of the LC7821N,7822N,7823N remains unchanged until they receive the address data assigned to them.

**Sample Application Circuit**

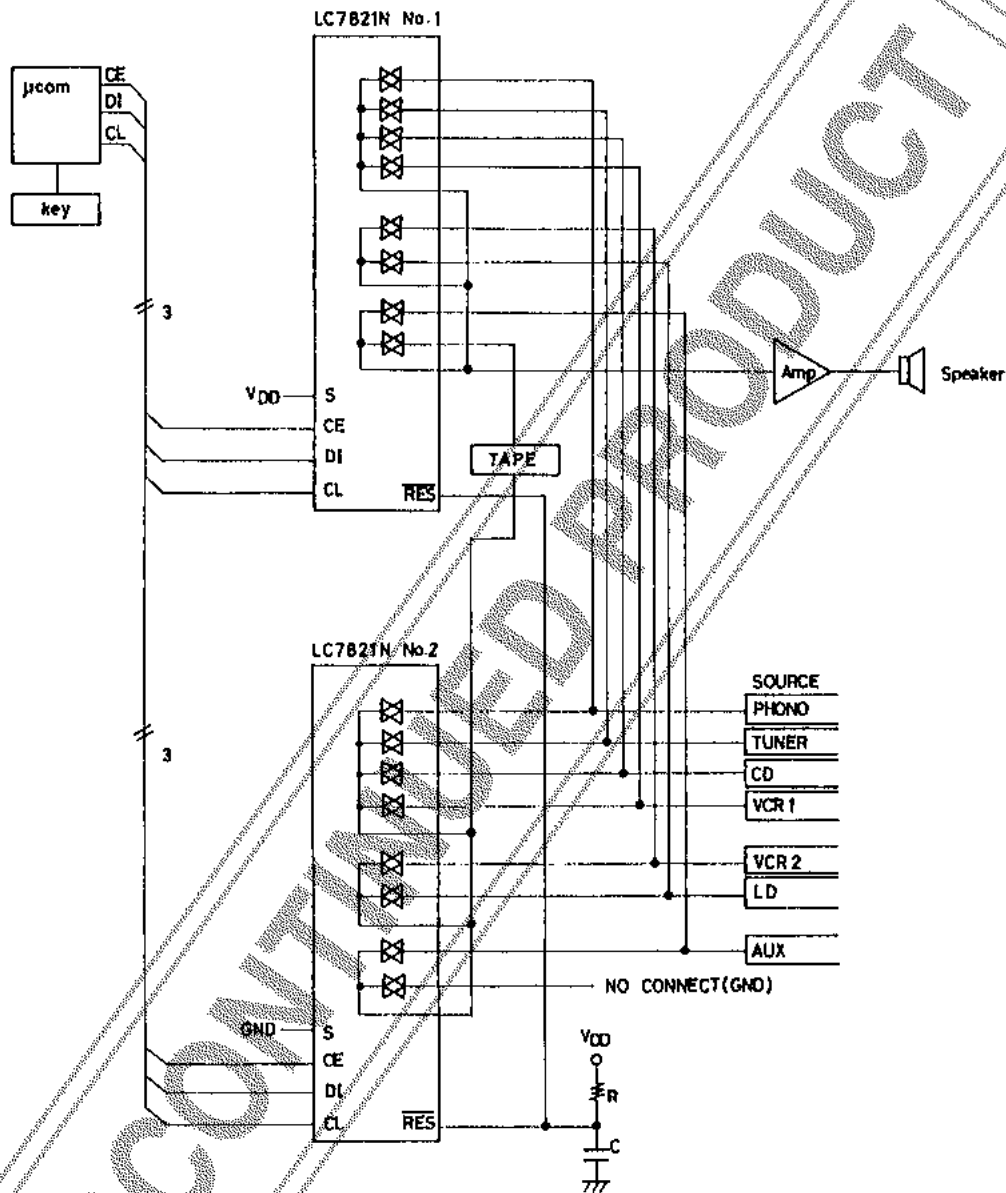

Note) The other channel also has the same connection.