

Features

- Triple amplifier topology
- 130 MHz -3 dB bandwidth ($A_V = +2$)
- 180 MHz -3 dB bandwidth ($A_V = +1$)
- Wide supply range, $\pm 2V$ to $\pm 15V$
- 80 mA output current (peak)
- Low cost
- 1500 V/ μs slew rate
- Input common mode range to within 1.5V of supplies
- 35 ns settling time to 0.1%
- Available in single (EL2160C), dual (EL2260C), and quad (EL2460C) form

Applications

- RGB amplifiers
- Video amplifiers
- Cable driver
- Test equipment amplifiers
- Current to voltage converters
- Video broadcast equipment

Ordering Information

Part No.	Temp. Range	Package	Outline #
EL2360CN	$-40^{\circ}C$ to $+85^{\circ}C$	16-Pin PDIP	MDP0031
EL2360CS	$-40^{\circ}C$ to $+85^{\circ}C$	16-Pin SOIC	MDP0027

General Description

The EL2360C is a triple current-feedback operational amplifier which achieves a -3 dB bandwidth of 130 MHz at a gain of $+2$. Built using the Elantec proprietary monolithic complementary bipolar process, these amplifiers use current mode feedback to achieve more bandwidth at a given gain than a conventional voltage feedback amplifier.

The EL2360C is designed to drive a double terminated 75Ω coax cable to video levels. It's fast slew rate of 1500 V/ μs , combined with the triple amplifier topology, makes its ideal for RGB video applications.

This amplifier can operate on any supply voltage from 4V ($\pm 2V$) to 33V ($\pm 16.5V$), yet consume only 8 mA per amplifier at any supply voltage. The EL2360C is available in 16-pin PDIP and SOIC packages.

For Single, Dual, or Quad applications, consider the EL2160C, EL2260C, or EL2460C all in industry standard pin outs. For Single applications with a power down feature, consider the EL2166C.

Connection Diagram

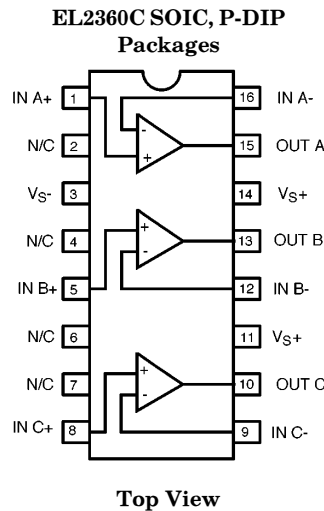

2360-1

Note: All information contained in this data sheet has been carefully checked and is believed to be accurate as of the date of publication; however, this data sheet cannot be a "controlled document". Current revisions, if any, to these specifications are maintained at the factory and are available upon your request. We recommend checking the revision level before finalization of your design documentation.

EL2360C

Triple 130 MHz Current Feedback Amplifier

Absolute Maximum Ratings ($T_A = 25^\circ\text{C}$)

Voltage between V_{S+} and V_{S-}	+33V	Output Current (continuous)	$\pm 50\text{ mA}$
Common-Mode Input Voltage	V_{S-} to V_{S+}	Operating Ambient Temperature Range	-40°C to $+85^\circ\text{C}$
Differential Input Voltage	$\pm 6\text{V}$	Operating Junction Temperature	150°C
Current into +IN or -IN	$\pm 10\text{ mA}$	Storage Temperature Range	-65°C to $+150^\circ\text{C}$
Internal Power Dissipation	See Curves		

Important Note:

All parameters having Min/Max specifications are guaranteed. The Test Level column indicates the specific device testing actually performed during production and Quality inspection. Elantec performs most electrical tests using modern high-speed automatic test equipment, specifically the LTX77 Series system. Unless otherwise noted, all tests are pulsed tests, therefore $T_J = T_C = T_A$.

Test Level	Test Procedure
I	100% production tested and QA sample tested per QA test plan QCX0002.
II	100% production tested at $T_A = 25^\circ\text{C}$ and QA sample tested at $T_A = 25^\circ\text{C}$, T_{MAX} and T_{MIN} per QA test plan QCX0002.
III	QA sample tested per QA test plan QCX0002.
IV	Parameter is guaranteed (but not tested) by Design and Characterization Data.
V	Parameter is typical value at $T_A = 25^\circ\text{C}$ for information purposes only.

DC Electrical Characteristics $V_S = \pm 15\text{V}$, $R_L = 150\Omega$, $T_A = 25^\circ\text{C}$ unless otherwise specified

Parameter	Description	Conditions	Min	Typ	Max	Test Level	Units
V_{OS}	Input Offset Voltage	$V_S = \pm 5\text{V}$, $\pm 15\text{V}$		2	10	I	mV
TCV_{OS}	Average Input Offset Voltage Drift, (Note 1)			10		V	$\mu\text{V}/^\circ\text{C}$
+ I_{IN}	+ Input Current	$V_S = \pm 5\text{V}$, $\pm 15\text{V}$		0.5	3	I	μA
- I_{IN}	- Input Current	$V_S = \pm 5\text{V}$, $\pm 15\text{V}$		5	25	I	μA
CMRR	Common Mode Rejection Ratio, (Note 2)	$V_S = \pm 5\text{V}$, $\pm 15\text{V}$	50	55		I	dB
-ICMR	- Input Current Common Mode Rejection, (Note 2)	$V_S = \pm 5\text{V}$, $\pm 15\text{V}$		0.2	5	I	$\mu\text{A}/\text{V}$
PSRR	Power Supply Rejection Ratio, (Note 3)		75	95		I	dB
-IPSR	- Input Current Power Supply Rejection, (Note 3)			0.2	5	I	$\mu\text{A}/\text{V}$
R_{OL}	Transimpedance, (Note 4)	$V_S = \pm 15\text{V}$, $R_L = 400\Omega$	500	2000		I	$\text{k}\Omega$
		$V_S = \pm 15\text{V}$, $R_L = 150\Omega$	500	1800		I	$\text{k}\Omega$
+ R_{IN}	+ Input Resistance		1.5	3		I	$\text{M}\Omega$
+ C_{IN}	+ Input Capacitance	PDIP package		1.5		V	pF
		SOIC package		1		V	pF
CMIR	Common Mode Input Range	$V_S = \pm 15\text{V}$		± 13.5		V	V
		$V_S = \pm 5\text{V}$		± 3.5		V	V

Note 1: Measured from T_{MIN} to T_{MAX} .

Note 2: $V_{CM} = \pm 10\text{V}$ for $V_S = \pm 15\text{V}$, $V_{CM} = \pm 3\text{V}$ for $V_S = \pm 5\text{V}$.

Note 3: The supplies are moved from $\pm 2.5\text{V}$ to $\pm 15\text{V}$.

Note 4: $V_{OUT} = \pm 7\text{V}$ for $V_S = \pm 15\text{V}$, $V_{OUT} = \pm 2\text{V}$ for $V_S = \pm 5\text{V}$.

EL2360C

Triple 130 MHz Current Feedback Amplifier

DC Electrical Characteristics $V_S = \pm 15V$, $R_L = 150\Omega$, $T_A = 25^\circ C$ unless otherwise specified — Contd.

Parameter	Description	Conditions	Min	Typ	Max	Test Level	Units
V_O	Output Voltage Swing	$V_S = \pm 15V$, $R_L = 400\Omega$	± 12	± 13.5		I	V
		$V_S = \pm 15V$, $R_L = 150\Omega$		± 12		V	V
		$V_S = \pm 5V$, $R_L = 150\Omega$	± 3.0	± 3.7		I	V
I_{SC}	Output Short Circuit Current, (Note 5)	$V_S = \pm 5V$, $\pm 15V$	60	100	150	I	mA
I_S	Supply Current (per amplifier)	$V_S = \pm 15V$		8.0	11.3	I	mA
		$V_S = \pm 5V$		5.7	8.8	I	mA

Note 5: A heat sink is required to keep junction temperature below absolute maximum when an output is shorted.

AC Electrical Characteristics (Note 8), $V_S = \pm 15V$, $A_V = +2$, $R_F = R_G = 560\Omega$, $R_L = 150\Omega$, $T_A = 25^\circ C$

unless otherwise specified.

Parameter	Description	Conditions	Min	Typ	Max	Test Level	Units
BW	-3 dB Bandwidth	$V_S = \pm 15V$, $A_V = +2$		130		V	MHz
		$V_S = \pm 15V$, $A_V = +1$		180		V	MHz
		$V_S = \pm 5V$, $A_V = +2$		100		V	MHz
		$V_S = \pm 5V$, $A_V = +1$		110		V	MHz
SR	Slew Rate (Note 6)	$R_L = 400\Omega$	1000	1500		IV	V/ μs
		$R_F = 1 k\Omega$, $R_G = 110\Omega$, $R_L = 400\Omega$		1500		V	V/ μs
t_r , t_f	Rise Time, Fall Time	$V_{OUT} = \pm 500 mV$		2.7		V	ns
t_{PD}	Propagation Delay	$V_{OUT} = \pm 500 mV$		3.2		V	ns
OS	Overshoot	$V_{OUT} = \pm 500 mV$		0		V	%
t_S	0.1% Settling Time	$V_{OUT} = \pm 2.5V$, $A_V = -1$		35		V	ns
dG	Differential Gain (Note 7)	$R_L = 150\Omega$		0.025		V	%
		$R_L = 500\Omega$		0.006		V	%
dP	Differential Phase (Note 7)	$R_L = 150\Omega$		0.1		V	$^\circ$
		$R_L = 500\Omega$		0.005		V	$^\circ$

Note 6: Slew Rate is with V_{OUT} from +10V to -10V and measured at +5V and -5V.

Note 7: DC offset from -0.714V to +0.714V, AC amplitude 286 mV_{P-P}, f = 3.58 MHz.

Note 8: All AC tests are performed on a "warmed up" part, except Slew Rate, which is pulse tested.

EL2360C

Triple 130 MHz Current Feedback Amplifier

Typical Performance Curves

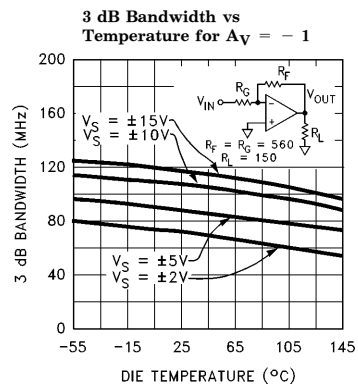
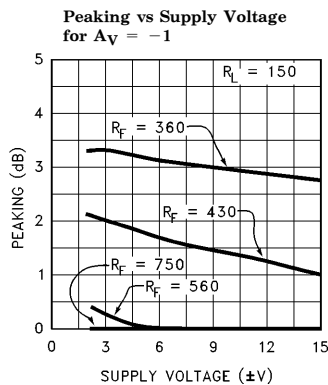
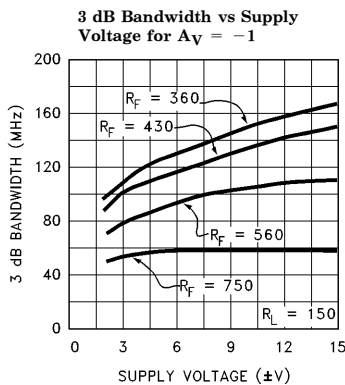
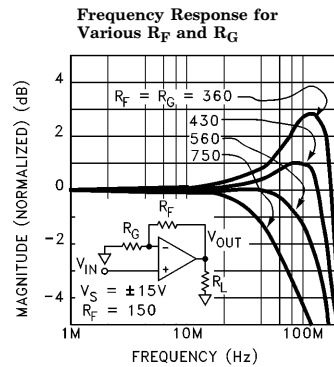
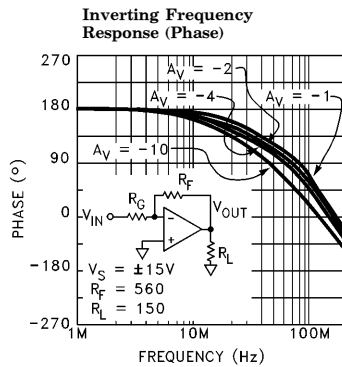
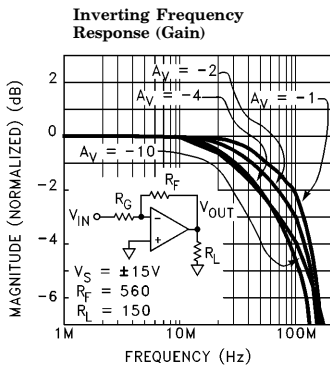
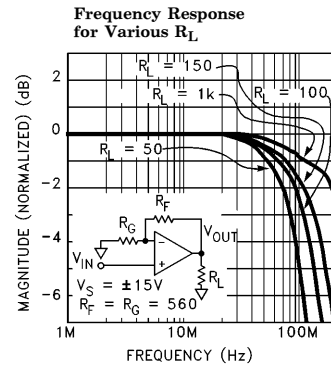
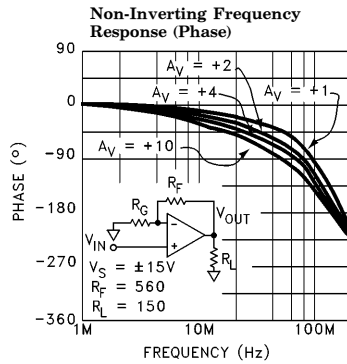
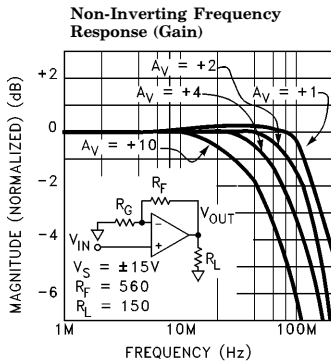

2360-2

EL2360C

Triple 130 MHz Current Feedback Amplifier

Typical Performance Curves — Contd.

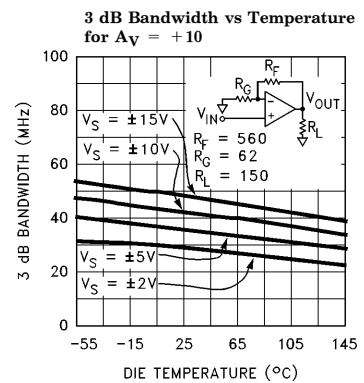
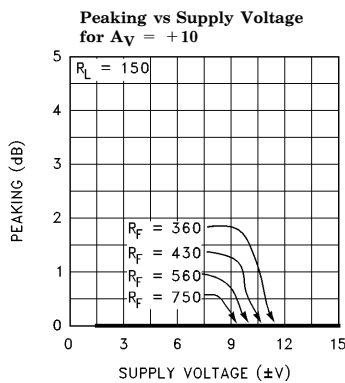
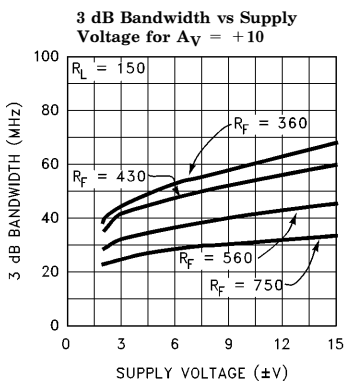
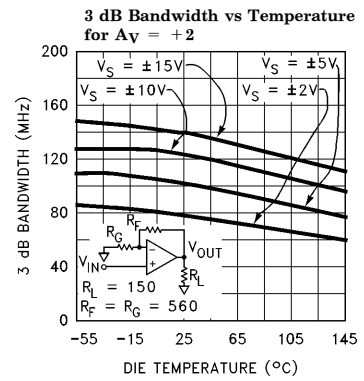
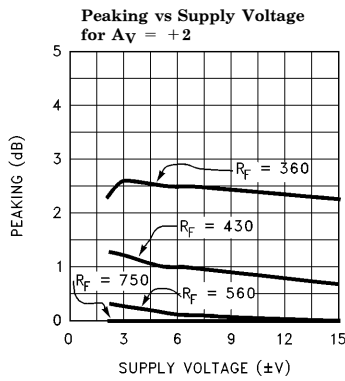
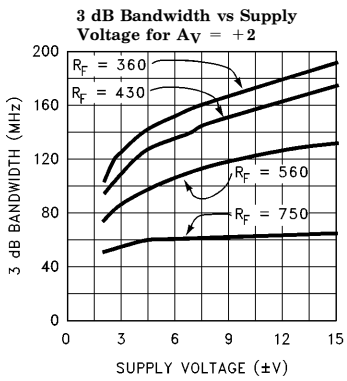
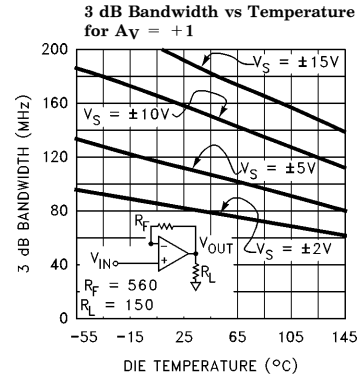
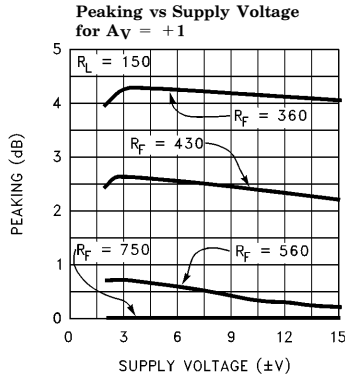
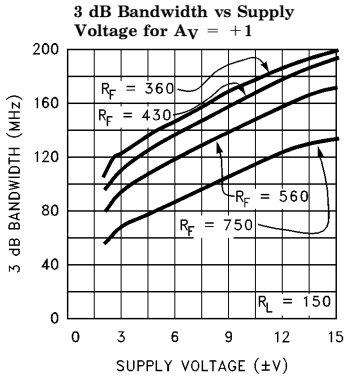

2360-3

EL2360C

Triple 130 MHz Current Feedback Amplifier

Typical Performance Curves — Contd.

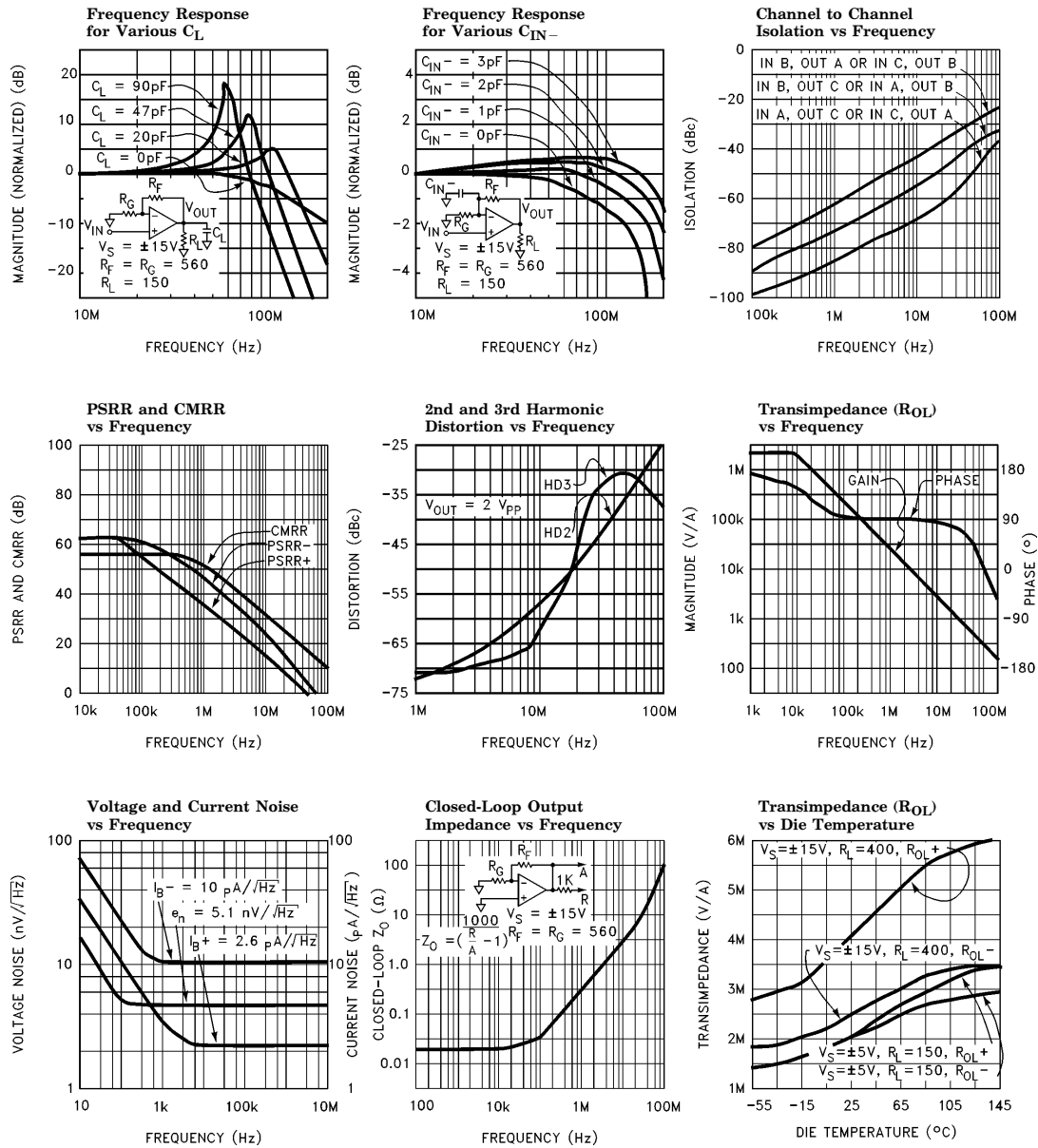

2360-4

EL2360C

Triple 130 MHz Current Feedback Amplifier

Typical Performance Curves — Contd.

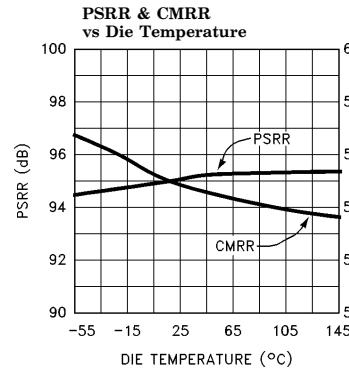
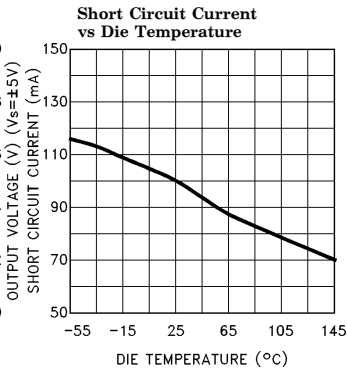
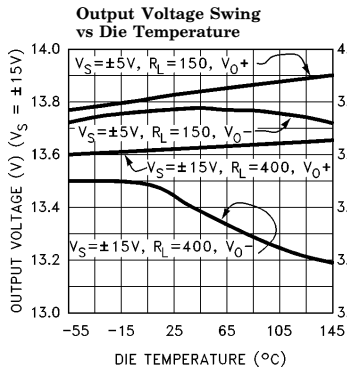
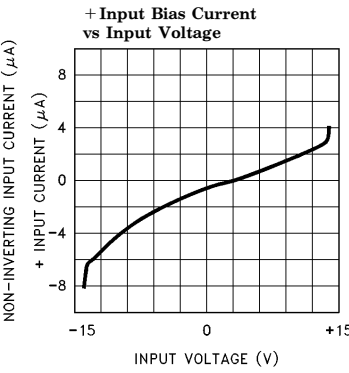
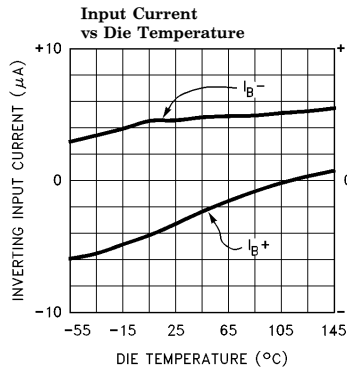
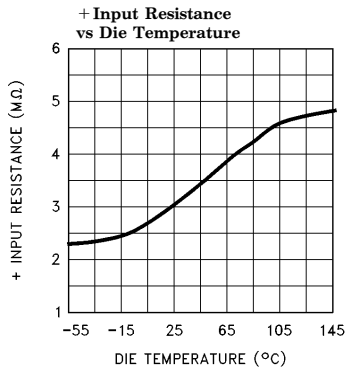
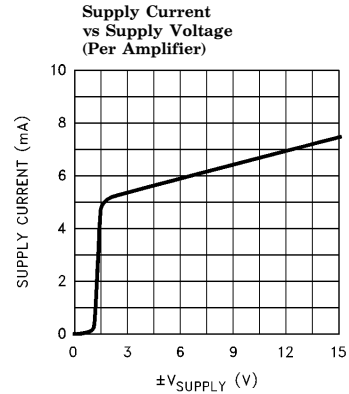
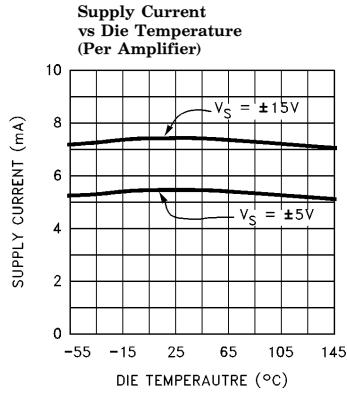
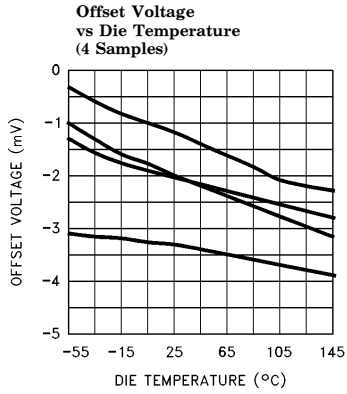

2360-5

EL2360C

Triple 130 MHz Current Feedback Amplifier

Typical Performance Curves — Contd.

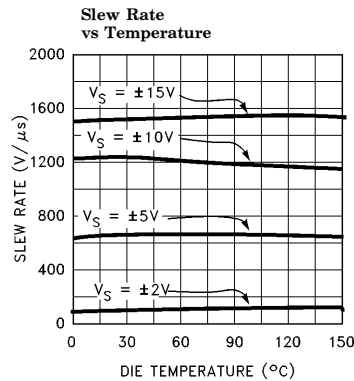
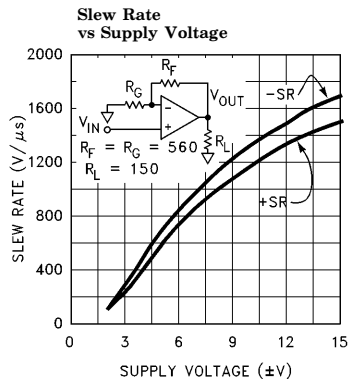
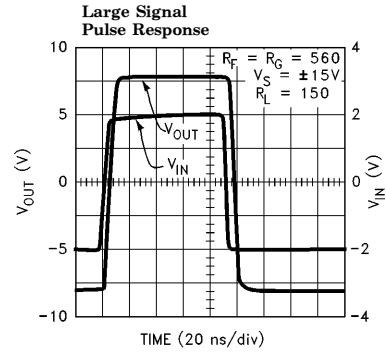
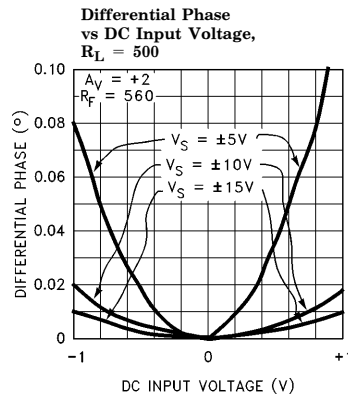
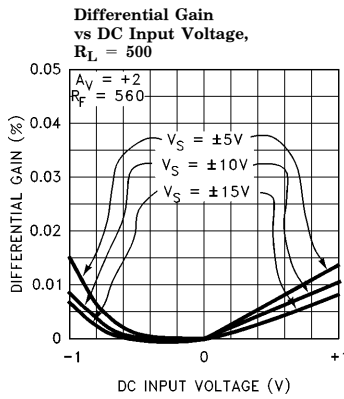
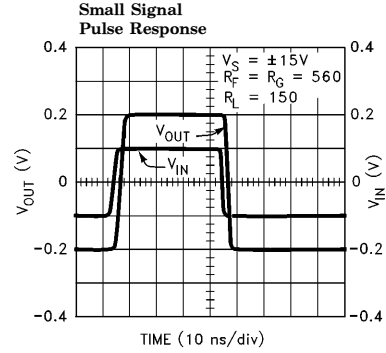
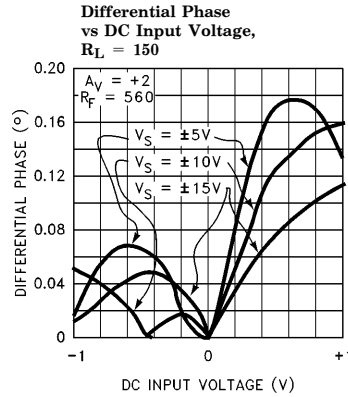
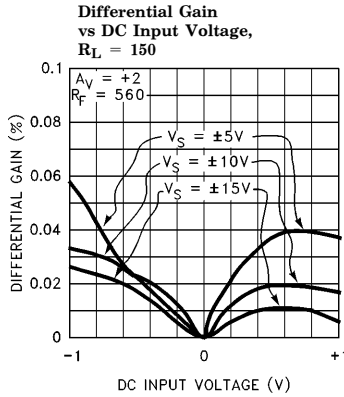

2360-6

EL2360C

Triple 130 MHz Current Feedback Amplifier

Typical Performance Curves — Contd.

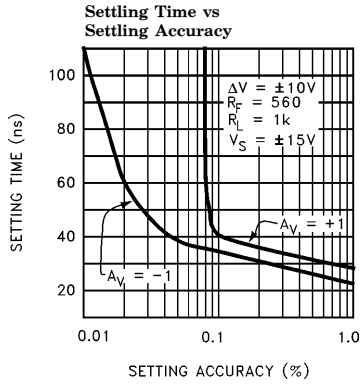

2360-15

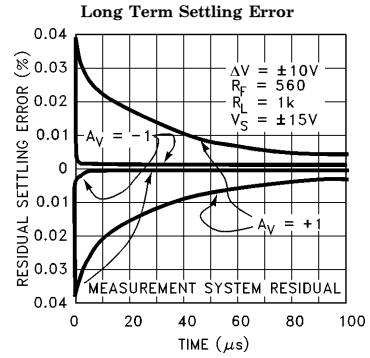

2360-16

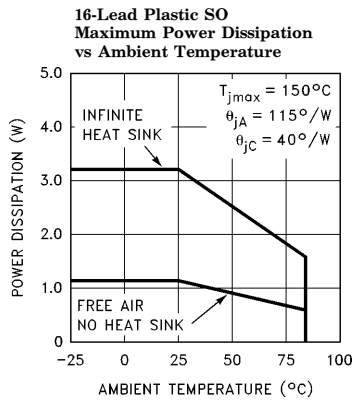

2360-7

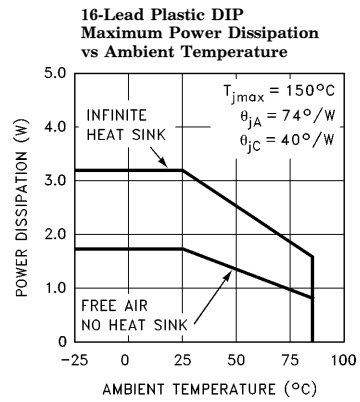

2360-8

EL2360C

Triple 130 MHz Current Feedback Amplifier

Differential Gain And Phase Test Circuit

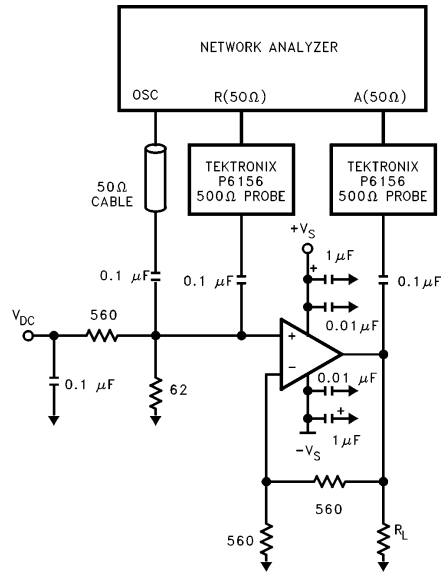

2360-9

Simplified Schematic (One Amplifier)

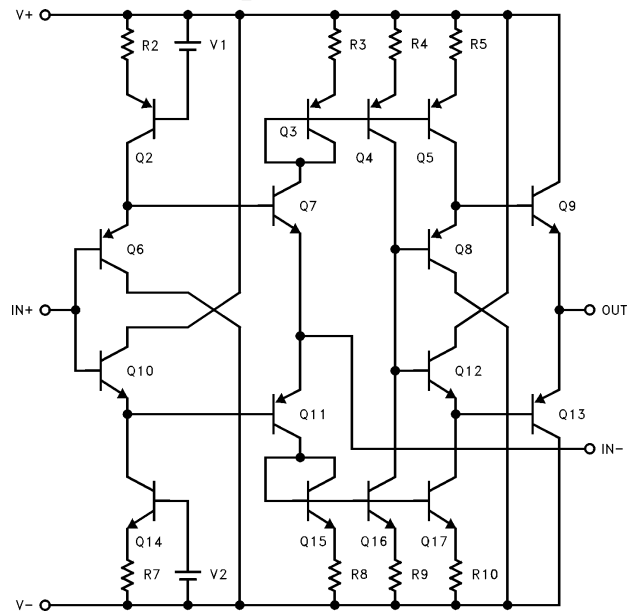

2360-10

EL2360C

Triple 130 MHz Current Feedback Amplifier

Applications Information

Product Description

The EL2360C is a triple current feedback amplifier that offers wide bandwidth and good video specifications at moderately low supply currents. It is built using Elantec's proprietary complimentary bipolar process and is offered in both a 16 pin PDIP and SOIC packages. Due to the current feedback architecture, the EL2360C closed-loop -3 dB bandwidth is dependent on the value of the feedback resistor. First the desired bandwidth is selected by choosing the feedback resistor, R_F , and then the gain is set by picking a gain resistor, R_G . The curves at the beginning of the Typical Performance Curves section show the effect of varying both R_F and R_G . The -3 dB bandwidth is somewhat dependent on the power supply voltage. As the supply voltage is decreased, internal junction capacitances increase, causing a reduction in the closed loop bandwidth. To compensate for this, smaller values of feedback resistor can be used at lower supply voltages.

Power Supply Bypassing and Printed Circuit Board Layout

As with any high-frequency device, good printed circuit board layout is necessary for optimum performance. Ground plane construction is highly recommended. Lead lengths should be as short as possible, preferably below $\frac{1}{4}$ ". The power supply pins must be well bypassed to reduce the risk of oscillation. The combination of a $1.0 \mu\text{F}$ tantalum capacitor in parallel with a $0.01 \mu\text{F}$ ceramic capacitor has been shown to work well when placed at each supply pin.

For good AC performance, parasitic capacitance should be kept to a minimum especially at the inverting input (see the Capacitance at the Inverting Input section). This implies keeping the ground plane away from this pin. Carbon or Metal-Film resistors are acceptable with the Metal-Film resistors giving slightly less peaking and bandwidth because of their additional series inductance. Use of sockets, particularly for the SO package should be avoided if possible. Sockets add parasitic inductance and capacitance which will result in some additional peaking and overshoot.

Capacitance at the Inverting Input

Any manufacturer's high-speed voltage- or current-feedback amplifier can be affected by stray capacitance at the inverting input. The characteristic curve of gain vs. frequency with variations in C_{IN-} emphasizes this effect. The curve illustrates how the bandwidth can be extended to beyond 200 MHz with some additional peaking with an additional 2pF of capacitance at the V_{IN-} pin. For inverting gains, this parasitic capacitance has little effect because the inverting input is a virtual ground, but for non-inverting gains, this capacitance (in conjunction with the feedback and gain resistors) creates a pole in the feedback path of the amplifier. This pole, if low enough in frequency, has the same destabilizing effect as a zero in the forward open-loop response. The use of large value feedback and gain resistors further exacerbates the problem by further lowering the pole frequency.

Feedback Resistor Values

The EL2360C has been designed and specified at a gain of $+2$ with $R_F = 560\Omega$. This value of feedback resistor yields relatively flat frequency response with little to no peaking out to 130 MHz. Since the EL2360C is a current-feedback amplifier, it is also possible to change the value of R_F to get more bandwidth. As seen in the curve of Frequency Response For Various R_F and R_G , bandwidth and peaking can be easily modified by varying the value of the feedback resistor. For example, by reducing R_F to 430Ω , bandwidth can be extended to 170 MHz with under 1 dB of peaking. Further reduction of R_F to 360Ω increases the bandwidth to 195 MHz with about 2.5 dB of peaking.

Bandwidth vs Temperature

Whereas many amplifier's supply current and consequently -3 dB bandwidth drop off at high temperature, the EL2360C was designed to have little supply current variation with temperature. An immediate benefit from this is that the -3 dB bandwidth does not drop off drastically with temperature. With $V_S = \pm 15\text{V}$ and $A_V = +2$, the bandwidth varies only from 150 MHz to 110 MHz over the entire die junction temperature range of $-50^\circ\text{C} < T < 150^\circ\text{C}$.

EL2360C

Triple 130 MHz Current Feedback Amplifier

Applications Information — Contd.

Supply Voltage Range and Single Supply Operation

The EL2360C has been designed to operate with supply voltages from $\pm 2\text{V}$ to $\pm 15\text{V}$. Optimum bandwidth, slew rate, and video characteristics are obtained at higher supply voltages. However, at $\pm 2\text{V}$ supplies, the -3 dB bandwidth at $A_V = +2$ is a respectable 70 MHz . The following figure is an oscilloscope plot of the EL2360C at $\pm 2\text{V}$ supplies, $A_V = +2$, $R_F = R_G = 560\Omega$, driving a load of 150Ω , showing a clean $\pm 600\text{ mV}$ signal at the output.

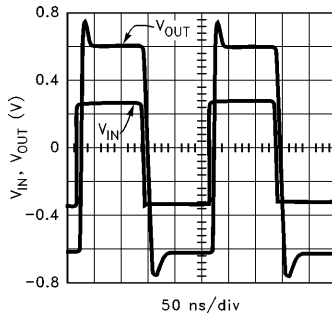

If a single supply is desired, values from $+4\text{V}$ to $+30\text{V}$ can be used as long as the input common mode range is not exceeded. When using a single supply, be sure to either 1) DC bias the inputs at an appropriate common mode voltage and AC couple the signal, or 2) ensure the driving signal is within the common mode range of the EL2360C, which is typically 1.5V from each supply rail.

Settling Characteristics

The EL2360C offers superb settling characteristics to 0.1% , typically in the 35 ns to 40 ns range. There are no aberrations created from the input stage which often cause longer settling times in other current feedback amplifiers. The EL2360C is not slew rate limited, therefore any size step up to $\pm 10\text{V}$ gives approximately the same settling time.

As can be seen from the Long Term Settling Error curve, for $A_V = +1$, there is approximately a 0.035% residual which tails away to 0.01% in about $40\ \mu\text{s}$. This is a thermal settling error

caused by a power dissipation differential (before and after the voltage step). For $A_V = -1$, due to the inverting mode configuration, this tail does not appear since the input stage does not experience the large voltage change as in the non-inverting mode. With $A_V = -1$, 0.01% settling time is slightly greater than 100 ns .

Power Dissipation

The EL2360C amplifier combines both high speed and large output current capability at a moderate supply current in very small packages. It is possible to exceed the maximum junction temperature allowed under certain supply voltage, temperature, and loading conditions. To ensure that the EL2360C remains within its absolute maximum ratings, the following discussion will help to avoid exceeding the maximum junction temperature.

The maximum power dissipation allowed in a package is determined according to [1]:

$$PD_{MAX} = \frac{T_{JMAX} - T_{AMAX}}{\theta_{JA}} \quad [1]$$

where:

T_{JMAX} = Maximum Junction Temperature
 T_{AMAX} = Maximum Ambient Temperature
 θ_{JA} = Thermal Resistance of the Package
 PD_{MAX} = Maximum Power Dissipation in the Package.

The maximum power dissipation actually produced by an IC is the total quiescent supply current times the total power supply voltage, plus the power in the IC due to the load, or [2]

$$PD_{MAX} = N \cdot (V_S \cdot I_{SMAX} + (V_S - V_{OUT}) \cdot \frac{V_{OUT}}{R_L}) \quad [2]$$

where:

N = Number of amplifiers
 V_S = Total Supply Voltage
 I_{SMAX} = Maximum Supply Current per amplifier
 V_{OUT} = Maximum Output Voltage of the Application
 R_L = Load Resistance tied to Ground

EL2360C

Triple 130 MHz Current Feedback Amplifier

Applications Information — Contd.

If we set the two PD_{MAX} equations, [1] and [2], equal to each other, and solve for V_S , we can get a family of curves for various loads and output voltages according to [3]:

$$V_S = \frac{R_L \cdot (T_{JMAX} - T_{AMAX})}{N \cdot \theta_{JA}} + (V_{OUT})^2 \quad [3]$$
$$(I_S \cdot R_L) + V_{OUT}$$

The figures below show total supply voltage V_S vs R_L for various output voltage swings for the PDIP and SOIC packages. The curves assume WORST CASE conditions of $T_A = +85^\circ\text{C}$ and $I_S = 11.3 \text{ mA}$ per amplifier. The curves do not include heat removal or forcing air, or the simple fact that the package will be attached to a circuit board, which can also provide some form of heat removal. Larger temperature and voltage ranges are possible with heat removal and forcing air past the part.

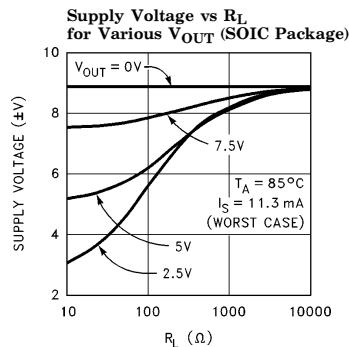
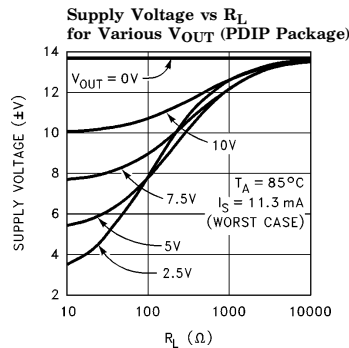

Current Limit

The EL2360C has internal current limits that protect the circuit in the event of an output being shorted to ground. This limit is set at 100 mA nominally and reduces with the junction temperature. At $T_J = 150^\circ\text{C}$, the current limits at about 65 mA. If any one output is shorted to ground, the power dissipation could be well over 1W, and much greater if all outputs are shorted. Heat removal is required in order for the EL2360C to survive an indefinite short.

Driving Cables and Capacitive Loads

When used as a cable driver, double termination is always recommended for reflection-free performance. For those applications, the back-termination series resistor will de-couple the EL2360C from the cable and allow extensive capacitive drive. However, other applications may have high capacitive loads without a back-termination resistor. In these applications, a small series resistor (usually between 5Ω and 50Ω) can be placed in series with the output to eliminate most peaking. The gain resistor (R_G) can then be chosen to make up for any gain loss which may be created by this additional resistor at the output. In many cases it is also possible to simply increase the value of the feedback resistor (R_F) to reduce the peaking.

EL2360C

Triple 130 MHz Current Feedback Amplifier

EL2360C Macromodel — Contd.

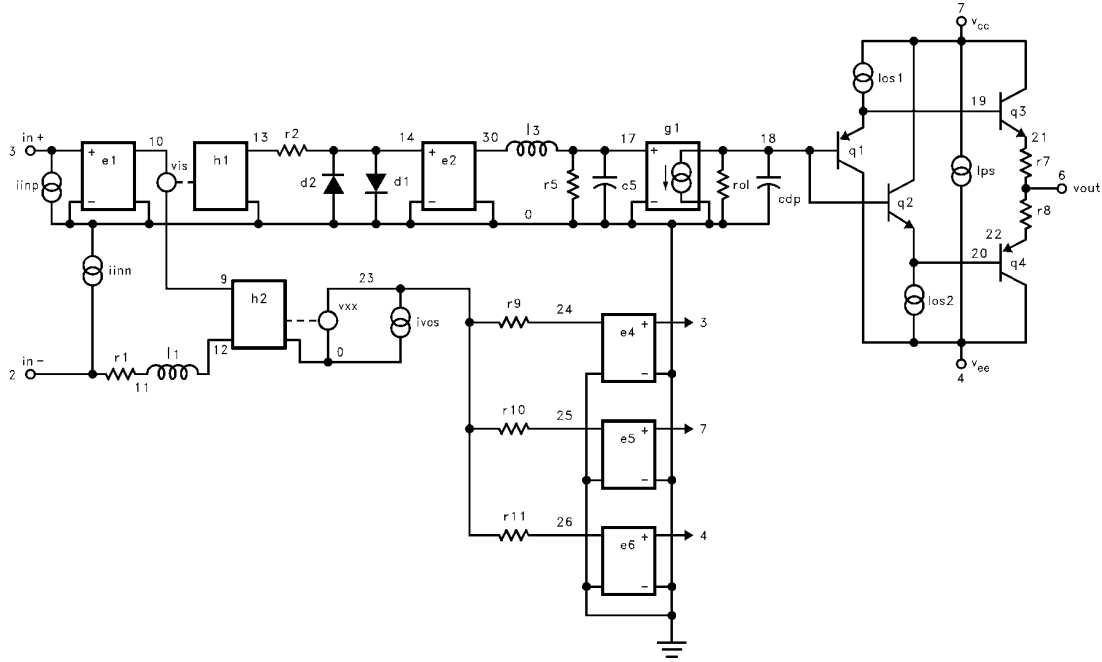

2360-14

EL2360C

Triple 130 MHz Current Feedback Amplifier

General Disclaimer

Specifications contained in this data sheet are in effect as of the publication date shown. Elantec, Inc. reserves the right to make changes in the circuitry or specifications contained herein at any time without notice. Elantec, Inc. assumes no responsibility for the use of any circuits described herein and makes no representations that they are free from patent infringement.

élantec
HIGH PERFORMANCE ANALOG INTEGRATED CIRCUITS

Elantec, Inc.

1996 Tarob Court

Milpitas, CA 95035

Telephone: (408) 945-1323

(800) 333-6314

Fax: (408) 945-9305

European Office: 44-71-482-4596

WARNING — Life Support Policy

Elantec, Inc. products are not authorized for and should not be used within Life Support Systems without the specific written consent of Elantec, Inc. Life Support systems are equipment intended to support or sustain life and whose failure to perform when properly used in accordance with instructions provided can be reasonably expected to result in significant personal injury or death. Users contemplating application of Elantec, Inc. products in Life Support Systems are requested to contact Elantec, Inc. factory headquarters to establish suitable terms & conditions for these applications. Elantec, Inc.'s warranty is limited to replacement of defective components and does not cover injury to persons or property or other consequential damages.