

MP7670

8-Channel, Voltage Output,
5 MHz, 4 Quadrant Multiplying
8-Bit D/A Converter
with Serial Digital Data Port



September 1998-2

FEATURES

- 8 Independent 4-Quadrant Multiplying 8-Bit DACs
- High Speed:
 - Settling Time: 2.5 μ s to ± 1 LSB (typ)
 - Slew Rate: 5 V/ μ s (typ)
 - Voltage Reference Input Bandwidth: 5 MHz ($V_{IN} = 100$ mV p-p)
- Low Power: 80 mW (typ)
- DACs Matched to $\pm 0.5\%$ (typ)
- Power on Preset to Zero Volts for All Outputs
- Midscale Preset, all DAC Outputs are Zero Volts
- Latch-Up Free
- Greater than 2000 V ESD Protection
- Guaranteed monotonic

APPLICATIONS

- Analog Multiplier Replacement
- High-Frequency Gain Control using DACs
- Convergence Adjustment for Displays and Monitors

GENERAL DESCRIPTION

The MP7670 is an 8-channel, 4 quadrant multiplying, 8-bit accurate digital-to-analog converter with a 5 MHz input bandwidth. It includes an output drive amplifier per channel capable of driving a ± 7 mA to a load. DNL of ± 0.25 LSB is achieved with a channel-to-channel matching of better than 0.5% (typ). Stability, matching, and precision of the DACs are achieved by using Exar's thin film technology.

The MP7670 is ideal for direct gain control of high frequency analog signals. The bipolar output amplifier has

low noise which produces a very sharp signal output particularly in display and monitor applications.

A proprietary subranging architecture provides wide signal bandwidth from V_{IN} to output up to 5 MHz (typ), fast output settling time, and V_{IN} feedthrough isolation of -60 dB (typ).

The MP7670 has a serial data 3-wire standard μ -processor logic interface to reduce pin count, package size, and board wire (space).

The MP7670 is fabricated on a junction isolated, high speed BiCMOS1TM process with thin film resistors.

ORDERING INFORMATION

Package Type	Temperature Range	Part No.
Plastic Dip	-40 to $+85^{\circ}$ C	MP7670AN
SOIC	-40 to $+85^{\circ}$ C	MP7670AS

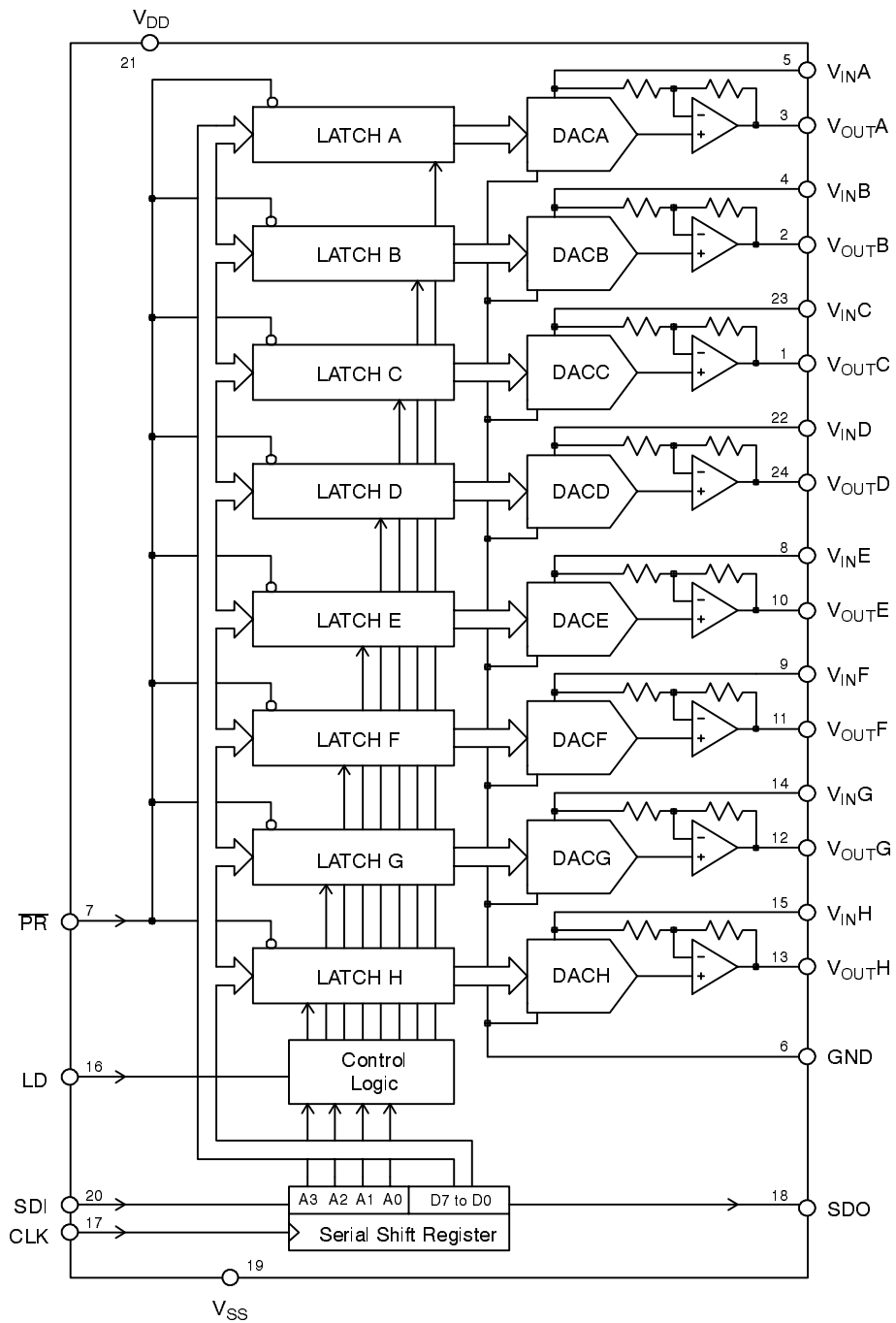
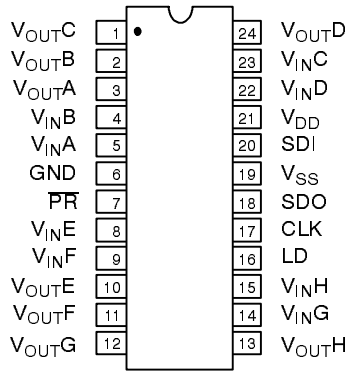
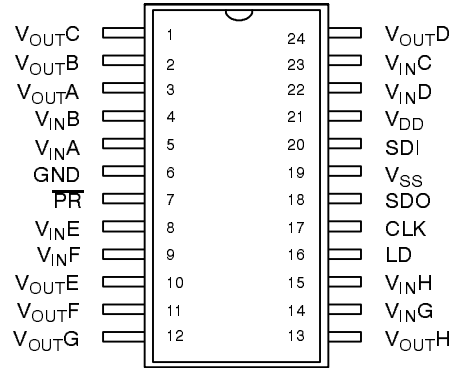

Figure 1. Simplified Block Diagram

PIN CONFIGURATION



24 Pin PDIP (0.300")



24 Pin SOIC (Jedec, 0.300")

PIN DESCRIPTION

PIN NO.	NAME	DESCRIPTION
1	V _{OUTC}	DAC C Output
2	V _{OUTB}	DAC B Output
3	V _{OUTA}	DAC A Output
4	V _{INB}	DAC B Reference Input
5	V _{INA}	DAC A Reference Input
6	GND	Ground
7	PR	Preset Input, Active Low
8	V _{INE}	DAC E Reference Input
9	V _{INF}	DAC F Reference Input
10	V _{OUTE}	DAC E Output
11	V _{OUTF}	DAC F Output
12	V _{OUTG}	DAC G Output

PIN NO.	NAME	DESCRIPTION
13	V _{OUTH}	DAC H Output
14	V _{ING}	DAC G Reference Input
15	V _{INH}	DAC H Reference Input
16	LD	Load DAC Register Strobe, Active High Input
17	CLK	Serial Clock Input
18	SDO	Serial Data Output
19	V _{SS}	Negative Power Supply
20	SDI	Serial Data Input
21	V _{DD}	Positive Power Supply
22	V _{IND}	DAC D Reference Input
23	V _{INC}	DAC C Reference Input
24	V _{OUTD}	DAC D Output

ELECTRICAL CHARACTERISTICS TABLE FOR DUAL SUPPLIES

Unless Otherwise Noted: $V_{DD} = 5\text{ V}$, $V_{SS} = -5\text{ V}$, $GND = 0\text{ V}$, $V_{INX} = 3\text{ V}$

Parameter	Symbol	25°C			Units	Test Conditions/Comments
		Min	Typ	Max		
DC CHARACTERISTICS						
Resolution (All Grades)	N	8			Bits	
Differential Non-Linearity	DNL		$\pm 1/4$	± 1	LSB	
Integral Non-Linearity	INL			± 1	LSB	
Monotonicity			Guaranteed			
Gain Error	GE		$\pm 1/2$		LSB	
DAC OUTPUT						
Output Offset	V_{BZE}		3	25	mV	$PR = 0$, Sets Code = 80 _H
Voltage Range	OVR	-3		3	V	
Output Current	I_{OUT}		± 10		mA	$\Delta V_{OUT} < 1\text{ LSB}$
Capacitive Load	CL			200	pF	No oscillations
REFERENCE INPUTS						
Input Resistance of one DAC	R_{IN}	5			K Ω	R_{IN} (typ) = 15K Ω //R _x R _x = 20K Ω /(1-Code/256)
Input Capacitance ²	C_{IN}		15	25	pF	
Voltage Range ¹	IVR	-3		3	V	
DYNAMIC CHARACTERISTICS²						
Input to Output Bandwidth Small Signal	BWS	2	5		MHz	Code = FS, $V_{INX} = 100\text{ mVp-p}$
Input to Output Bandwidth Large Signal	BWL		3		MHz	Code = FS, $V_{INX} = 1\text{ Vp-p}$
Slew Rate	SR		5		V/ μ s	Measured 10% to 90%, $\Delta V_{OUTX} = \pm 6\text{ V}$
V_{IN} Feedthrough	F_{DT}		-60		dB	Code = HS, up to $f = 100\text{ kHz}$
Total Harmonic Distortion	T_{HD}		0.02		%	$V_{INX} = 4\text{ V p-p}$, Code = FS $f = 1\text{ kHz}$, $f_{LP} = 80\text{ kHz}$
Spot Noise Voltage	e_N		0.17		$\mu\text{V}/\sqrt{\text{Hz}}$	$f = 1\text{ kHz}$
Output Settling Time	t_S		2.5	5.0	μ s	$\pm 1\text{ LSB}$, Code = 0 to FS
Channel-to-Channel Crosstalk	C_T	60			dB	Measured between adjacent channels, $f = 100\text{ kHz}$
Digital Feedthrough	Q		6		nVs	$V_{INX} = 0\text{ V}$, Code = 0 to FS
DIGITAL INPUTS						
Logic High ³	V_{IH}	2.4			V	
Logic Low ³	V_{IL}			0.8	V	
Input Current	I_L			± 1	μ A	
Input Capacitance ²	C_L			8	pF	
DIGITAL OUTPUTS						
Logic High	V_{OH}	3.5			V	$I_{OH} = -0.4\text{ mA}$
Logic Low	V_{OL}			0.4	V	$I_{OL} = 1.6\text{ mA}$

ELECTRICAL CHARACTERISTICS TABLE

Description	Symbol	25° C			Units	Conditions
		Min	Typ	Max		
POWER SUPPLIES						
Power Supply Range	V_{DD}	4.5		5.5	V	
	V_{SS}	-5.5		-4.5	V	
Power Supply Rejection Ratio						
Positive	PSRR+		0.0002	0.01	%/%	$\overline{PR} = 0\text{ V}, \Delta V_{DD} = \pm 5\%$
Negative	PSRR-		0.0002	0.01	%/%	$\overline{PR} = 0\text{ V}, \Delta V_{SS} = \pm 5\%$
Power Dissipation	P_{DISS}		80	130	mW	$\overline{PR} = 0\text{ V}$
Power Supply Current	I_{DD}		8	13	mA	$\overline{PR} = 0\text{ V}$
Negative Supply Current	I_{SS}		8	13	mA	$\overline{PR} = 0\text{ V}$
DIGITAL TIMING SPECIFICATIONS^{2, 4}						
Input Clock Pulse Width	t_{CH}, t_{CL}	80			ns	
Data Setup Time	t_{DS}	40			ns	
Data Hold Time	t_{DH}	20			ns	
CLK to SDO Propagation Delay	t_{PD}			160	ns	
Load Pulse Width	t_{LD}	70			ns	
Preset Pulse Width	t_{PR}	50			ns	
Clock Edge to Load	t_{CKLD}	30			ns	
Load Edge to Next Clk Edge	t_{LDCK}	60			ns	

NOTES

- ¹ Maximum input voltage is 2 V less than V_{DD} .
- ² Guaranteed but not production tested.
- ³ Digital input levels should not go below ground or exceed the positive supply voltage, otherwise damage may occur.
- ⁴ See timing diagram.

Specifications are subject to change without notice

ABSOLUTE MAXIMUM RATINGS (TA = +25°C unless otherwise noted)^{1, 2}

V_{DD} to GND	+6.5 V	Maximum Junction Temperature	-65°C to +150°C
V_{SS} to GND	-6.5 V	Storage Temperature	150°C
V_{INA-H} to GND	V_{DD} to V_{SS}	Lead Temperature (Soldering 10 seconds)	+300°C
V_{OUTA-H} to GND	V_{DD} to V_{SS}	Package Power Dissipation Rating @ 75°C	
Digital Input & Output Voltage to GND	-0.5 to V_{DD} +0.5 V	PDIP, SOIC	1000mW
Operating Temperature Range		Derates above 75°C	14mW/°C
Extended Industrial	-40°C to +85°C		

NOTES:

- ¹ Stresses above those listed under "Absolute Maximum Ratings" may cause permanent damage to the device. This is a stress rating only and functional operation at or above this specification is not implied. Exposure to maximum rating conditions for extended periods may affect device reliability.
- ² Any input pin which can see a value outside the absolute maximum ratings should be protected by Schottky diode clamps (HP5082-2835) from input pin to the supplies. All inputs have protection diodes which will protect the device from short transients outside the supplies of less than 100mA for less than 100µs.

THEORY OF OPERATION

The MP7670 contains 8 independent 4-quadrant multiplying D/A converters with output amplifiers. The design has incorporated a novel approach that provides fast, accurate, low noise, low distortion, small size, and low power in the same device. This device is particularly useful in applications where multipliers are used to perform the gain adjustment function for high frequency analog signal conditioning. Also note that typical multipliers tend to increase noise particularly for low gain settings and have high offsets. The MP7670 design delivers a very low, constant noise, and low offset with digital control through the entire gain ranges of the D/A converter.

Linearity Characteristics

Each D/A converter in the MP7670 achieves $DNL \leq \pm 0.25$ LSB (typ), and gain error $\leq \pm 0.2\%$ (typ). Since all 8 channels of MP7670 are fabricated in the same IC, the linearity, gain matching, and input-output characteristics of all 8 channels match extremely well.

The Logic Interface and Serial Port

The MP7670 is equipped with a serial data 3-wire standard μ -processor logic interface to reduce pin count, package size, and board wire (small size). This interface consists of LD which controls the transfer of data to the selected DAC channels that are fed through the SDI (serial digital data and address bits) with

the CLK (digital input shift register clock). Please refer to the following timing diagrams and truth tables for logic details.

A SDO (serial digital data output driver) is connected to the other side of the input shift register and would save SDI bus space by allowing the daisy chaining of several MP7670s (connecting SDI of device 2 to SDO of device 1).

When the LD signal is low, CLK signal loads the digital input bits (SDI) into the 12-bit shift register. The LD signal going high loads this data into the selected DACs. Also, when the PR signal is low, the output of all DACs would be reset to 0 volts.

Power Supplies and Input Voltage Ranges

The MP7670 is capable of functioning with $\pm 5V$ and $\pm 3V$ supplies. The output and input DC ranges are limited to within $\pm 2V$ from each positive and negative supplies. For example, with supplies at $\pm 5V$, the recommended output range is $\pm 3V$.

The MP7670 design eliminates any code dependent current change into its GND, hence easing the board level design by eliminating the stringent need for other types of DACs for low GND impedance wiring considerations at board level.

Each output of the MP7670 DAC has an output amplifier driver delivering less than 0.05Ω of output impedance through a push-pull linear output stage. Each output and input characteristics parameter match extremely well, given that all channels are fabricated in the same IC.

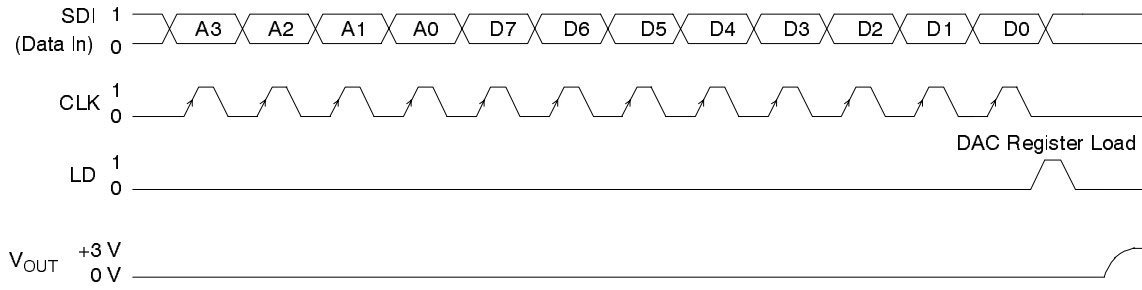

Figure 2. Serial Data Timing and Loading

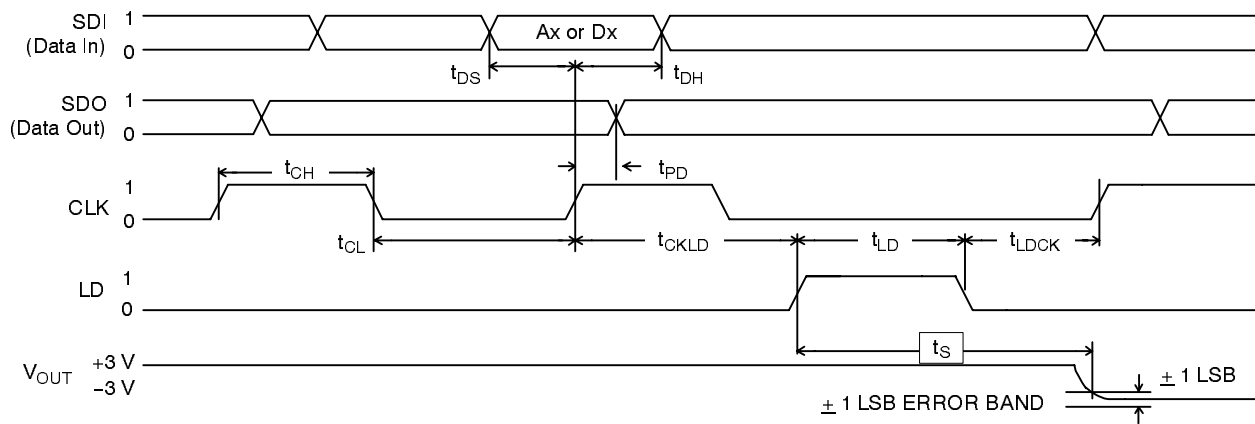

Figure 3. Detail Serial Data Input Timing (PR = "1")

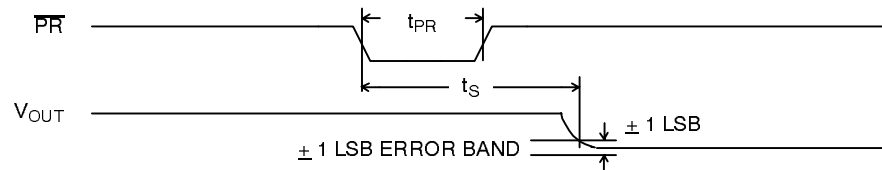

Figure 4. PRESET Timing

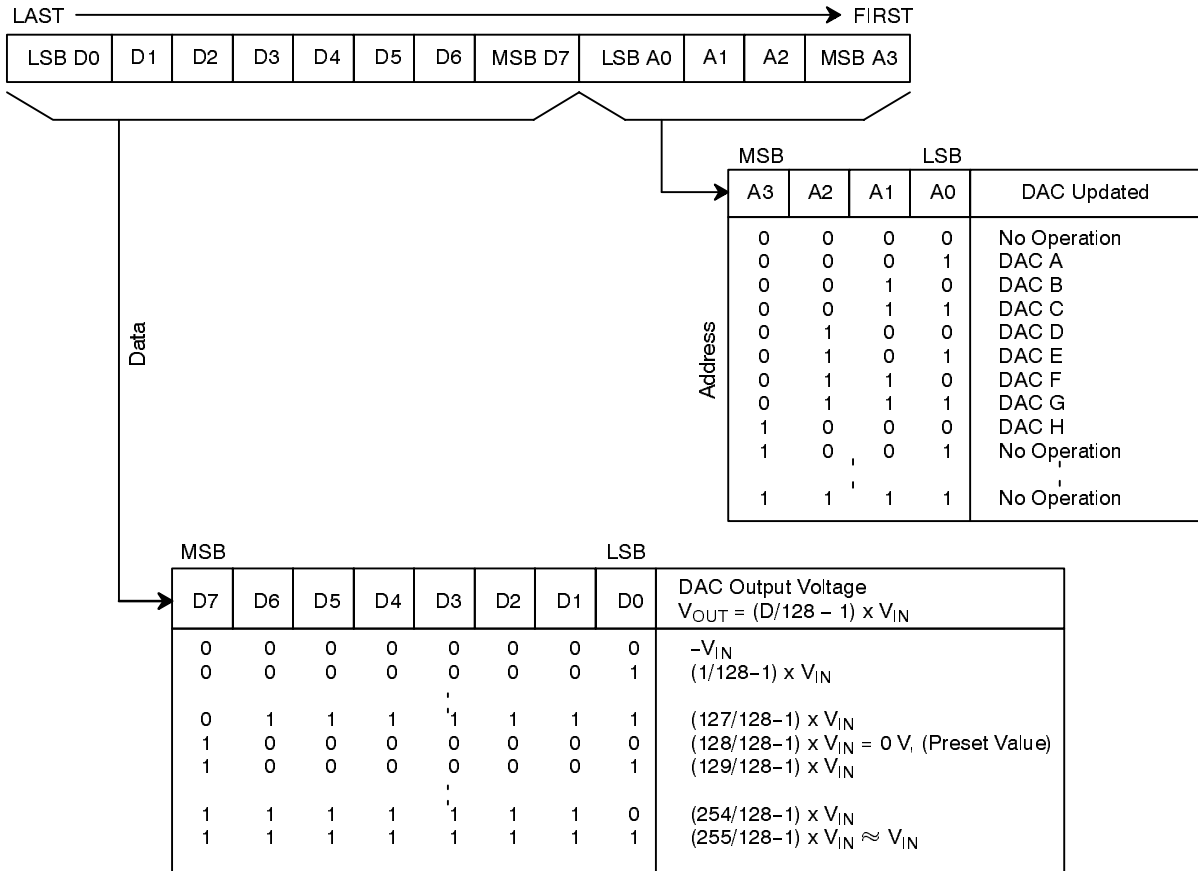

Table 1. Serial Input Format

SDI	CLK	LD	$\overline{\text{PR}}$	Input Shift Register Operation
X	L	L	H	No Operation
X	↑	L	H	Shift One Bit In from SDI (Pin 20), Shift One Bit* Out from SDO (Pin 18)
X	X	L	L	All DAC Registers = 80 _H
X	L	H	H	Load Serial Register Data into DAC(X) Register

*Data shifted into the SDI pin appears twelve clocks later at the SDO pin.

Table 2. Control Logic Truth Table

Decimal Input (D)	$V_{OUT} (D)$	Comments ($V_{IN} = 3 \text{ V}$)
0	-3.00 V	Inverted FS
1	-2.98	
127	-0.02	
128	0.00	Zero Output
129	0.02	
254	2.95	Full Scale (FS)
255	2.98	

Table 3. DAC Transfer Function

PERFORMANCE CHARACTERISTICS

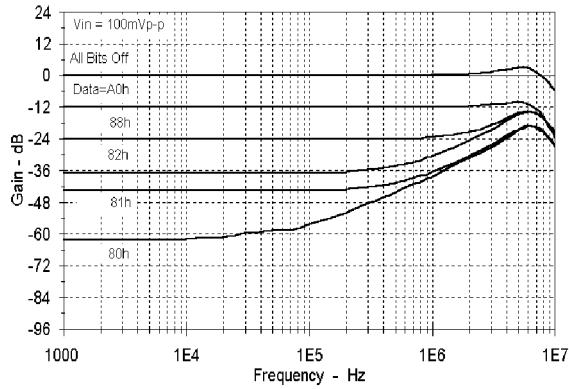

Graph 1. Gain (V_{OUT}/V_{IN}) and Feedthrough vs. Frequency

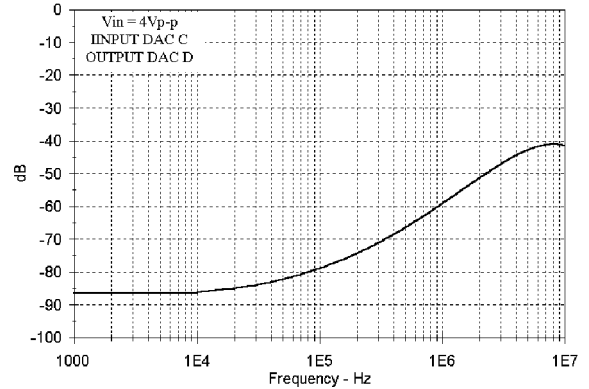

Graph 2. DAC Crosstalk vs. Frequency

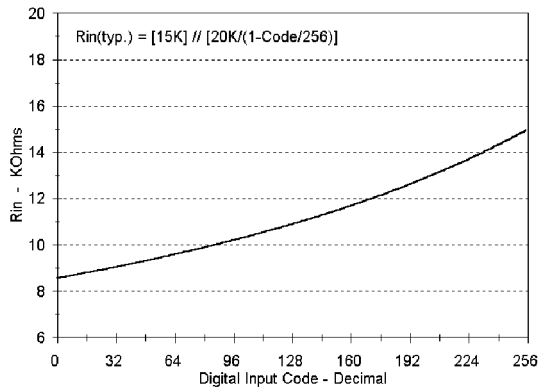

Graph 3. DAC Input Resistance vs. Digital Input Code

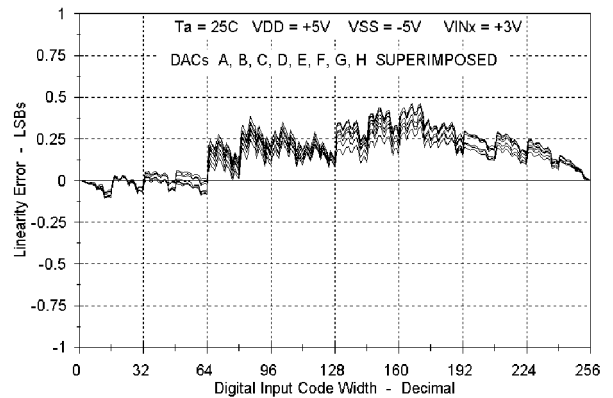

Graph 4. Linearity Error vs. Digital Input Code

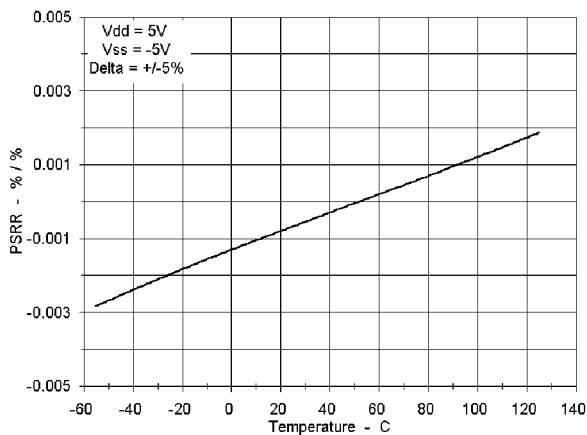

Graph 5. PSRR (DC) vs. Temperature

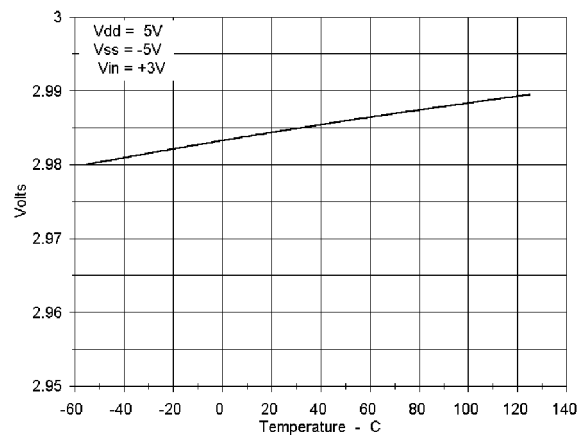

Graph 6. V_{OUT} Full Scale vs. Temperature

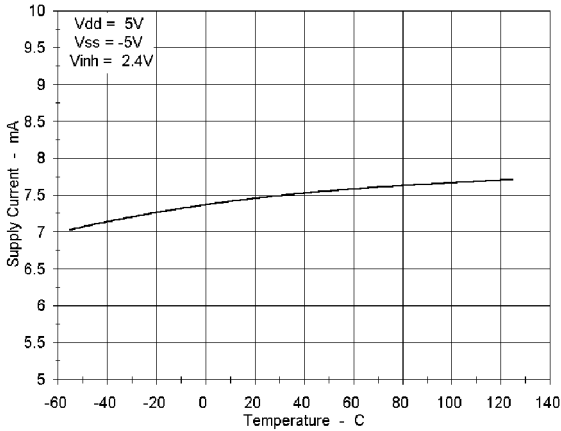

Graph 7. Supply Current (I_{DD}) vs. Temperature

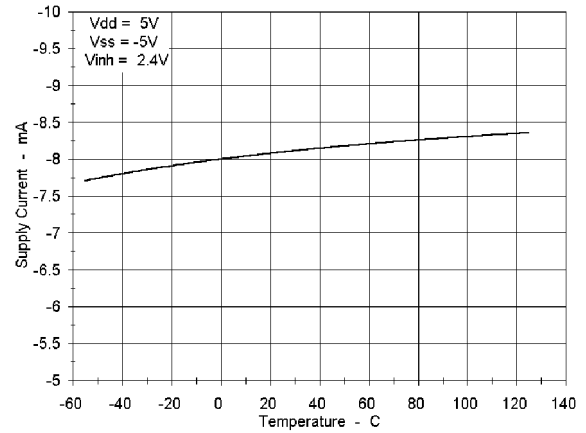

Graph 8. Supply Current (I_{SS}) vs. Temperature

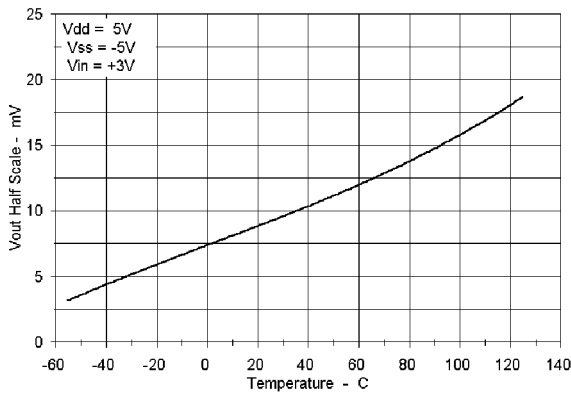

Graph 9. V_{OUT} Offset Error vs. Temperature

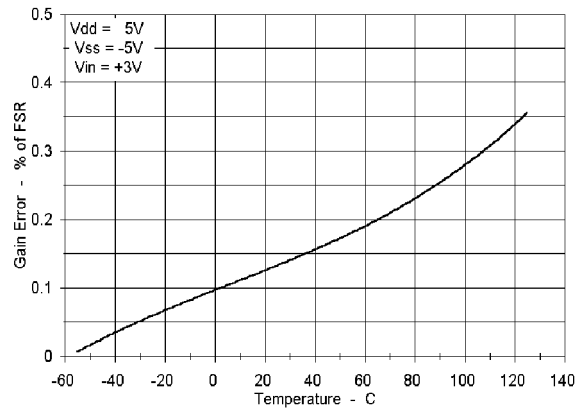

Graph 10. Gain Error vs. Temperature

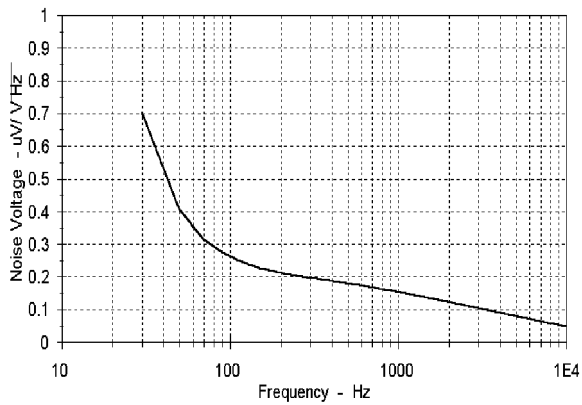

Graph 11. Voltage Noise Density vs. Frequency

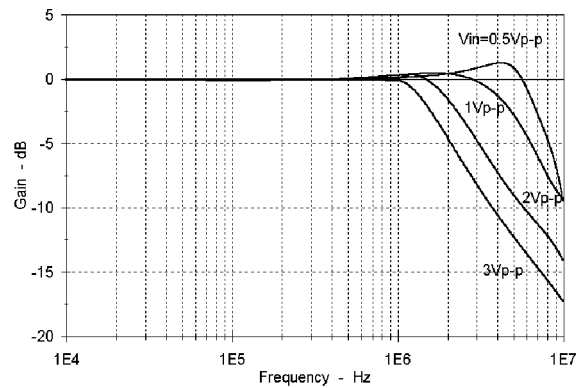

Graph 12. Varying Reference Input DAC Gain vs. Frequency

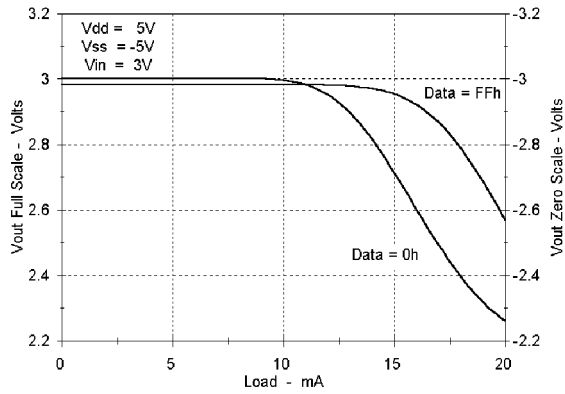

Graph 13. V_{OUT} Output Drive Capability

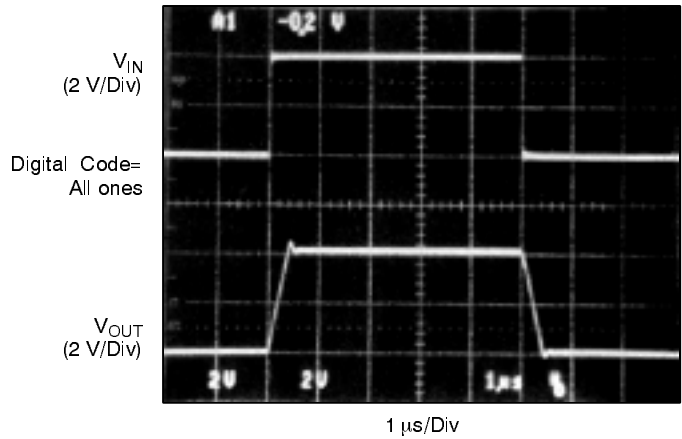

Graph 14. Pulse Response

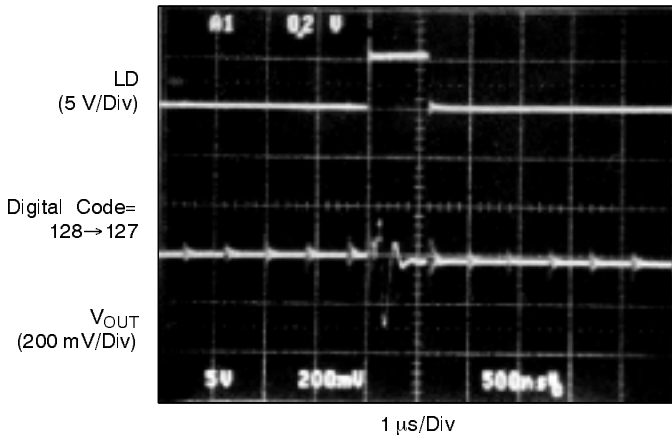

Graph 15. 1 LSB Digital Step Change

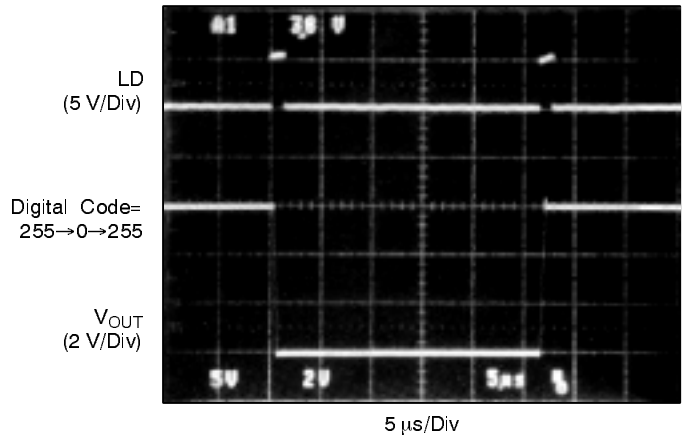

Graph 16. Settling Time

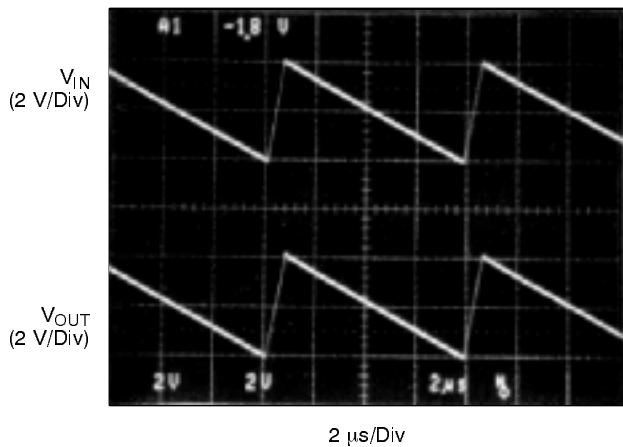

Graph 17. 128kHz Sawtooth Waveform Response

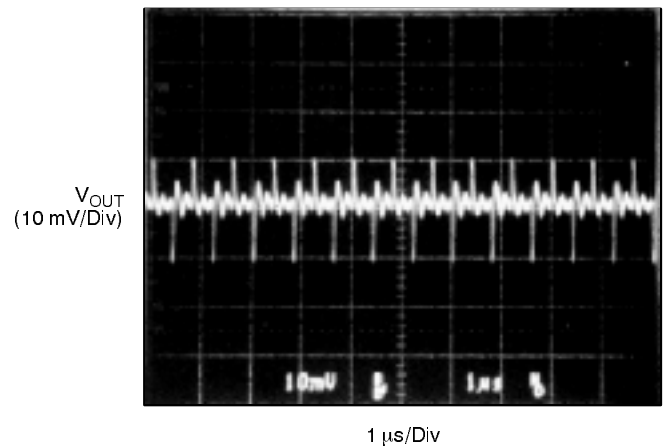

Graph 18. Clock Feedthrough

V_{OUT}
(20 mV/Div)

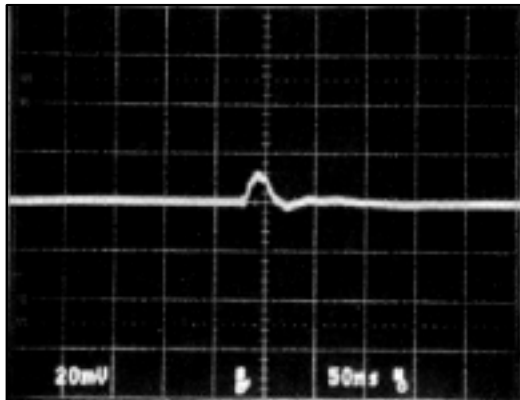

50 ns/Div

Graph 19. Digital Crosstalk

V_{OUT}
(5 dB/Div)

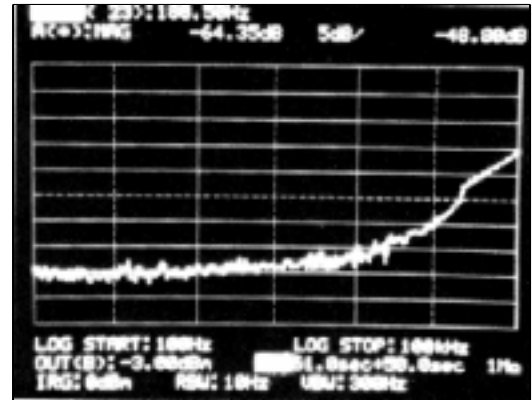

kHz

Graph 20. PSRR vs. Frequency

Gain
(5 dB/Div)

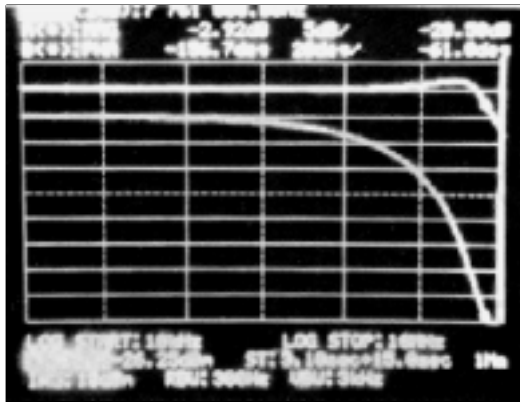

MHz

Graph 21. Gain & Phase vs. Frequency

V_{OUT}
(20 mV/Div)

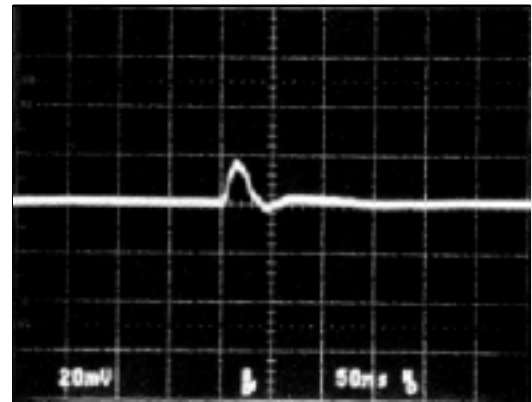

50 ns/Div

Graph 22. Digital Feedthrough

**24 LEAD PLASTIC DUAL-IN-LINE
(300 MIL PDIP)**

Rev. 1.00

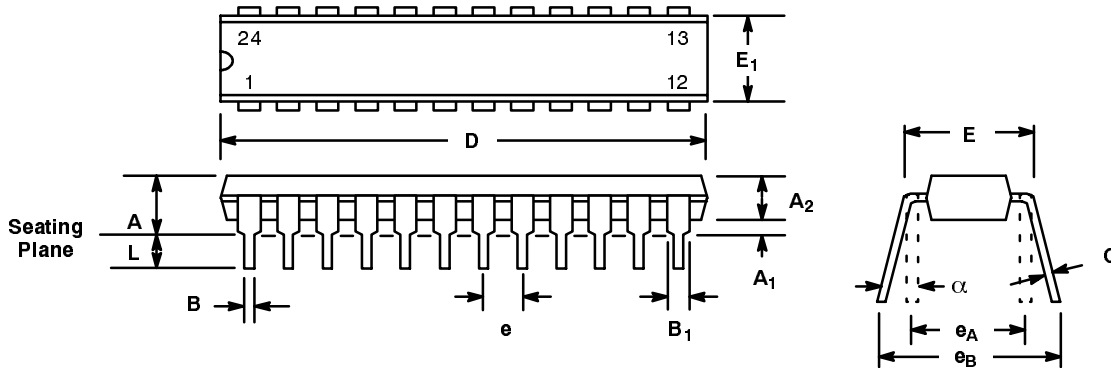

SYMBOL	INCHES		MILLIMETERS	
	MIN	MAX	MIN	MAX
A	0.145	0.210	3.68	5.33
A ₁	0.015	0.070	0.38	1.78
A ₂	0.115	0.195	2.92	4.95
B	0.014	0.024	0.36	0.56
B ₁	0.030	0.070	0.76	1.78
C	0.008	0.014	0.20	0.38
D	1.125	1.275	28.58	32.39
E	0.300	0.325	7.62	8.26
E ₁	0.240	0.280	6.10	7.11
e	0.100 BSC		2.54 BSC	
e _A	0.300 BSC		7.62 BSC	
e _B	0.310	0.430	7.87	10.92
L	0.115	0.160	2.92	5.08
α	0°	15°	0°	15°

Note: The control dimension is the inch column

24 LEAD SMALL OUTLINE (300 MIL JEDEC SOIC)

Rev. 1.00

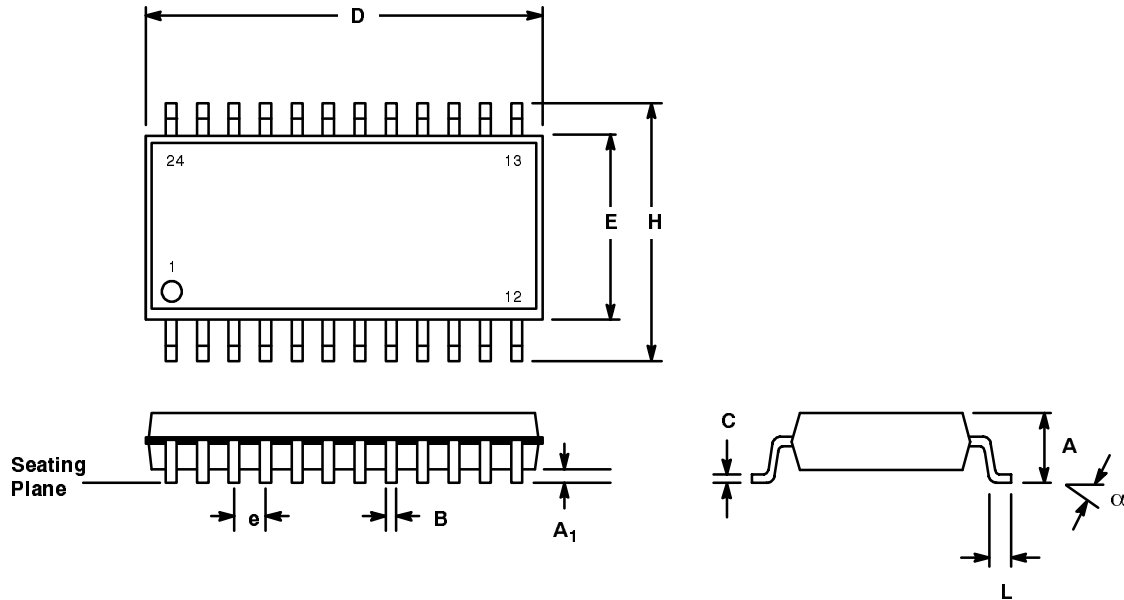

SYMBOL	INCHES		MILLIMETERS	
	MIN	MAX	MIN	MAX
A	0.093	0.104	2.35	2.65
A1	0.004	0.012	0.10	0.30
B	0.013	0.020	0.33	0.51
C	0.009	0.013	0.23	0.32
D	0.598	0.614	15.20	15.60
E	0.291	0.299	7.40	7.60
e	0.050 BSC		1.27 BSC	
H	0.394	0.419	10.00	10.65
L	0.016	0.050	0.40	1.27
α	0°	8°	0°	8°

Note: The control dimension is the millimeter column

Notes

NOTICE

EXAR Corporation reserves the right to make changes to the products contained in this publication in order to improve design, performance or reliability. EXAR Corporation assumes no responsibility for the use of any circuits described herein, conveys no license under any patent or other right, and makes no representation that the circuits are free of patent infringement. Charts and schedules contained here in are only for illustration purposes and may vary depending upon a user's specific application. While the information in this publication has been carefully checked; no responsibility, however, is assumed for inaccuracies.

EXAR Corporation does not recommend the use of any of its products in life support applications where the failure or malfunction of the product can reasonably be expected to cause failure of the life support system or to significantly affect its safety or effectiveness. Products are not authorized for use in such applications unless EXAR Corporation receives, in writing, assurances to its satisfaction that: (a) the risk of injury or damage has been minimized; (b) the user assumes all such risks; (c) potential liability of EXAR Corporation is adequately protected under the circumstances.

All trademarks and registered trademarks are property of their respective owners.

Copyright 1998 EXAR Corporation

Datasheet September 1998

Reproduction, in part or whole, without the prior written consent of EXAR Corporation is prohibited.