

## SOT23 MICROPOWER (4 $\mu$ A) 1.22V VOLTAGE REFERENCE

### DESCRIPTION

The ZXRE1004 is a 1.22 volt bandgap reference circuit designed for ultra low current operation, typically 4 $\mu$ A. The device is available in a SOT23 surface mount package offering the ultimate in space and power saving. These features make the ZXRE1004 particularly suitable for portable and battery powered applications.

SOT23 tolerance selection is available to 0.5% for precision applications. Excellent performance is

maintained over the 8 $\mu$ A to 20mA operating current range with a typical temperature coefficient of only 20ppm/ $^{\circ}$ C. The device has been designed to be highly tolerant of capacitive loads so maintaining excellent stability.

As well as the SOT23, the ZXRE1004 can offer a pin for pin compatible alternative to the REF1004, LT1004 and LM185/385 series of voltage references with SO8 and E-Line (TO92 style) equivalents .

### FEATURES

- High performance alternative to REF1004, LT1004 and LM185/385 references
- 4 $\mu$ A typical knee current
- Small outline SOT23 package
- SO8 and E-Line alternatives available
- 20ppm/ $^{\circ}$ C typical temperature coefficient
- Unconditionally stable
- 0.5%, 1%, 2% and 3% tolerance
- Contact Zetex marketing for availability of tighter tolerance devices

### APPLICATIONS

- Battery powered equipment
- Precision power supplies
- Portable instrumentation
- Portable communications devices
- Notebook and palmtop computers
- Data acquisition systems
- A/D and D/A converters
- Test equipment

### SCHEMATIC DIAGRAM

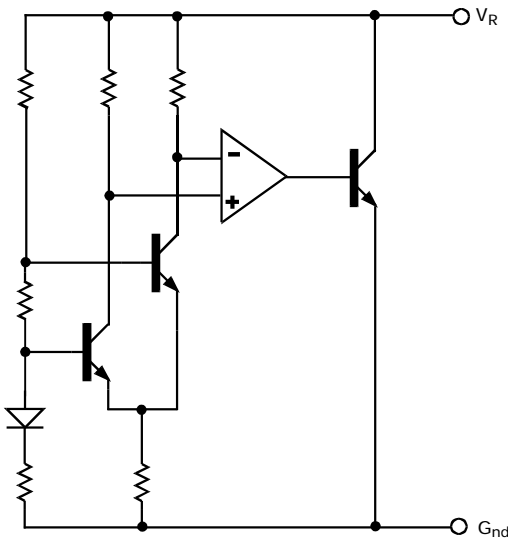

### APPLICATIONS CIRCUIT

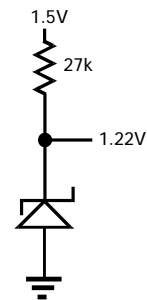

Ultra low quiescent reference from a 1.5V battery source.

# ZXRE1004

## ABSOLUTE MAXIMUM RATINGS

Reverse Current	30mA	Power Dissipation (T <sub>amb</sub> =25°C)	
Forward Current	10mA	SOT23	330mW
Operating temperature.	-40 to 85°C	SO8	625mW
Storage temperature.	-55 to 125°C	E-Line	500mW

## ELECTRICAL CHARACTERISTICS

TEST CONDITIONS (Unless otherwise stated) T<sub>amb</sub>=25°C

SYMBOL	PARAMETER	CONDITIONS	LIMITS			TOL. %	UNITS
			MIN	TYP	MAX		
V <sub>R</sub>	Reverse Breakdown Voltage	I <sub>R</sub> =100μA	1.214 1.208 1.196 1.183	1.22 1.22 1.22 1.22	1.226 1.232 1.244 1.257	0.5 ‡ 1 2 3	V
I <sub>MIN</sub>	Minimum Knee Current			4	8		μA
I <sub>R</sub>	Recommended Operating Current Range		0.008		20		mA
T <sub>C</sub> †	Average Reverse Breakdown Voltage Temperature Coefficient	I <sub>R(min)</sub> to I <sub>R(max)</sub>		20	75		ppm/°C
$\frac{\Delta V_R}{\Delta I_R}$	Reverse Breakdown Voltage change with Current	I <sub>R</sub> =8μA to 1mA I <sub>R</sub> =1mA to 20mA			1 10		mV mV
Z <sub>R</sub>	Reverse Dynamic Impedance	I <sub>R</sub> = 1mA f = 100Hz I <sub>AC</sub> =0.1 I <sub>R</sub>		0.2	0.6		Ω
E <sub>N</sub>	Wideband Noise Voltage	I <sub>R</sub> =8μA to 100μA f=10Hz to 10kHz		60			μV(rms)

$$\dagger T_C = \frac{(V_{R(max)} - V_{R(min)}) \times 1000000}{V_R \times (T_{(max)} - T_{(min)})}$$

Note: V<sub>R(max)</sub> - V<sub>R(min)</sub> is the maximum deviation in reference voltage measured over the full operating temperature range.

‡ Note: 0.5% SOT23 only

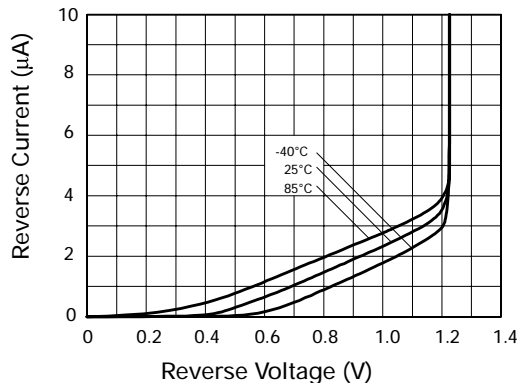

Reverse Characteristics

ISSUE 2 - JUNE 1999



## TYPICAL CHARACTERISTICS

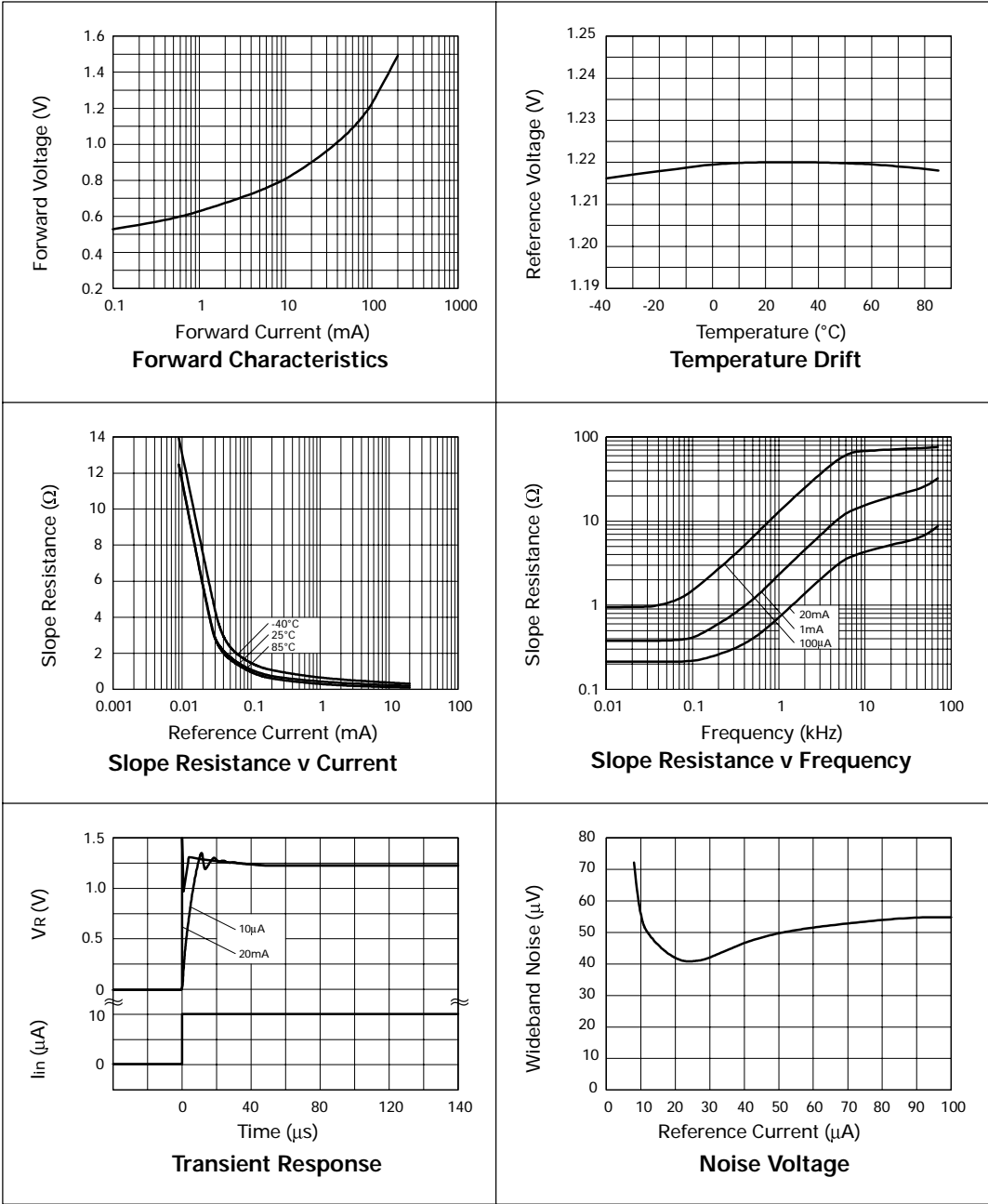

# ZXRE1004

## Ordering Information

Device	TOL%	Package	Partmarking
ZXRE1004CF	0.5	SOT23	10D
ZXRE1004DF	1	SOT23	10C
ZXRE1004EF	2	SOT23	10B
ZXRE1004FF	3	SOT23	10A
ZXRE1004DN8 †	1	SO8	ZXRE1004D
ZXRE1004EN8 †	2	SO8	ZXRE1004E
ZXRE1004FN8 †	3	SO8	ZXRE1004F
ZXRE1004DR †	1	E-Line	ZXRE1004D
ZXRE1004ER †	2	E-Line	ZXRE1004E
ZXRE1004FR †	3	E-Line	ZXRE1004F

†Contact Zetex marketing for availability of these package options

### NOTE:

for tape and reel options add suffix TA to the part number  
eg ZXRE1004DFTA

## Connection Diagrams

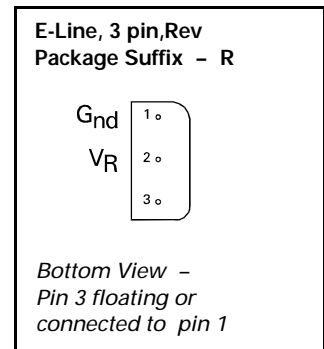
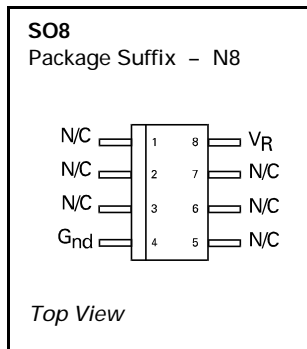
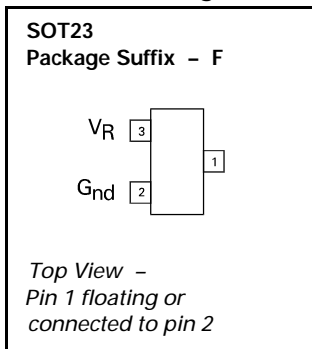

Zetex plc.  
Fields New Road, Chadderton, Oldham, OL9-8NP, United Kingdom.  
Telephone: (44)161 622 4422 (Sales), (44)161 622 4444 (General Enquiries)  
Fax: (44)161 622 4420

Zetex GmbH  
Streitfeldstraße 19  
D-81673 München  
Germany  
Telephone: (49) 89 45 49 49 0  
Fax: (49) 89 45 49 49 49

Zetex Inc.  
47 Mall Drive, Unit 4  
Commack NY 11725  
USA  
Telephone: (516) 543-7100  
Fax: (516) 864-7630

Zetex (Asia) Ltd.  
3510 Metroplaza, Tower 2  
Hing Fong Road,  
Kwai Fong, Hong Kong  
Telephone: (852) 26100 611  
Fax: (852) 24250 494

These are supported by  
agents and distributors in  
major countries world-wide  
© Zetex plc 1999

Internet: <http://www.zetex.com>

This publication is issued to provide outline information only which (unless agreed by the Company in writing) may not be used, applied or reproduced for any purpose or form part of any order or contract or be regarded as a representation relating to the products or services concerned. The Company reserves the right to alter without notice the specification, design, price or conditions of supply of any product or service.