



LA70011, 70011M

Recording/Playback Amplifier for VHS VCRs

Overview

The LA70011 and LA70011M are recording/playback amplifiers for VHS VCR video signals. When used in combination with the LA71000M and LA71500M Series of video signal processing ICs, they permit Y/C recording without current adjustment.

Features

- Connecting the playback amplifier input directly to the head reduces the number of external elements required.
- The recording amplifiers use a fixed-current drive configuration that yields stable recording characteristics even under changing loads. They include built-in automatic gain control circuits.
- Using the same dimensions and pin assignments as the LA70001 and LA70001M permits the use of the same circuit boards as these earlier chips. The LA70011 can also be mounted at the right end of an LA70020 socket.

Package Dimensions

unit: mm

3067-DIP24S

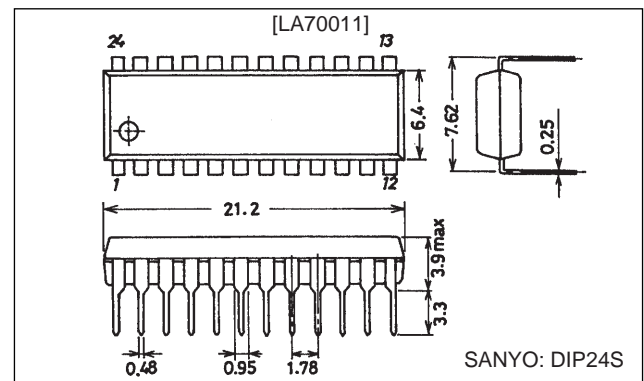

unit: mm

3112-MFP24S

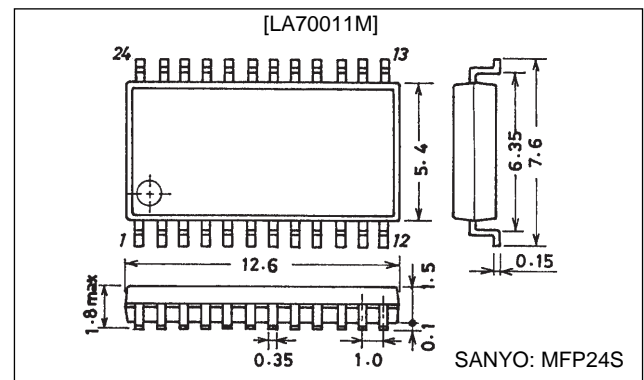

Specifications

Maximum Ratings at $T_a = 25^\circ\text{C}$

Parameter	Symbol	Conditions	Ratings	Unit
Maximum power supply voltage	$V_{CC \text{ max}}$		7.0	V
Maximum power dissipation	$P_d \text{ max}$	$T_a \leq 65^\circ\text{C}$ [LA70011]	600	mW
		$T_a \leq 65^\circ\text{C}$ [LA70011M] 114.3 × 76.1 × 1.6 mm: glass epoxy	500	mW
Operating temperature	T_{opr}		-10 to +65	$^\circ\text{C}$
Storage temperature	T_{stg}		-40 to +150	$^\circ\text{C}$

Operating Conditions at $T_a = 25^\circ\text{C}$

Parameter	Symbol	Conditions	Ratings	Unit
Recommended power supply voltage	V_{CC}		5.0	V
Operating power supply voltage range	$V_{CC \text{ op}}$		4.8 to 5.5	V

LA70011, 70011M

Operating Characteristics at Ta = 25°C

Parameter	Symbol	Conditions	Ratings			Unit
			min	typ	max	
Playback Mode						
Current drain	I _{CCP}	Current flowing into pin 13	44	53	60	mA
Voltage gain	SP-L CH1 G _{VP1}	V _{IN} = 38 mVp-p, f = 1 MHz	56	59	62	dB
	SP-H CH2 G _{VP2}		56	59	62	dB
	EP-L CH3 G _{VP3}		56	59	62	dB
	EP-H CH4 G _{VP4}		56	59	62	dB
Voltage gain difference	ΔG _{VP1}	G _{VP1} — G _{VP2}	-1	0	+1	dB
	ΔG _{VP2}	G _{VP3} — G _{VP4}	-1	0	+1	dB
Intermode gain difference	ΔG _{VP3}	G _{VP3} — G _{VP1}	-1	0	+1	dB
Converted input noise voltage	CH1 V _{NIN1} CH2 V _{NIN2} CH3 V _{NIN3} CH4 V _{NIN4}	Ratio of the output from a 1.1 MHz low pass filter to the output with no input under the same conditions as those used for measuring voltage gain.		1.0	1.5	μVrms
Frequency characteristic	CH1 ΔV _{fp1} CH2 ΔV _{fp2} CH3 ΔV _{fp3} CH4 ΔV _{fp4}	Ratios of the output for V _{IN} = 38 mVp-p and f = 7 MHz to the voltage gains G _{VP1} , G _{VP2} , G _{VP3} , and G _{VP4} .	-2.5	0		dB
Secondary harmonic distortion	CH1 ΔV _{HDP1} CH2 ΔV _{HDP2} CH3 ΔV _{HDP3} CH4 ΔV _{HDP4}	Ratio of the 8 MHz (secondary) component of the output to its 4 MHz (primary) component for V _{IN} = 38 mVp-p and f = 4 MHz.		-40	-35	dB
Maximum output level	CH1 ΔV _{OMP1} CH2 ΔV _{OMP2} CH3 ΔV _{OMP3} CH4 ΔV _{OMP4}	Output level, for f = 1 MHz, at which the ratio of the 3 MHz (tertiary) component to the 1 MHz (primary) component is -30 dB.	1.0	1.2		Vp-p
Crosstalk SP	V _{CR1}	Ratio of the output for V _{IN} = 38 mVp-p and f = 4 MHz to G _{VP1} .		-40	-35	dB
	V _{CR2}	Ratio of the output for V _{IN} = 38 mVp-p and f = 4 MHz to G _{VP2} .		-40	-35	dB
Crosstalk EP	V _{CR3}	Ratio of the output for V _{IN} = 38 mVp-p and f = 4 MHz to G _{VP3} .		-40	-35	dB
	V _{CR4}	Ratio of the output for V _{IN} = 38 mVp-p and f = 4 MHz to G _{VP4} .		-40	-35	dB
Output DC offset	ΔV _{ODC1}	CH1 — CH2	-100	0	+100	mV
	ΔV _{ODC2}	CH3 — CH4				
	ΔV _{ODC3}	CH1 — CH3				
	ΔV _{ODC4}	CH2 — CH4				
	ΔV _{ODC5}	CH1 — CH4				
	ΔV _{ODC6}	CH2 — CH3				
Envelope detector output pin voltage	V _{ENV}	T6 DC level with no signal input.	0.0	08	1.3	V
Envelope detector output pin voltage SP	V _{ENVSP1}	T6 DC level at which T7A output level is 175 mVp-p for f = 4 MHz.	2.0	2.5	3.0	V
	V _{ENVSP2}	T6 DC level at which T7A output level is 400 mVp-p for f = 4 MHz.	4.0	4.5	5.0	V
Envelope detector output pin voltage EP	V _{ENVEP1}	T6 DC level at which T7A output level is 125 mVp-p for f = 4 MHz.	2.0	2.5	3.0	V
	V _{ENVEP2}	T6 DC level at which T7A output level is 300 mVp-p for f = 4 MHz.	4.0	4.5	5.0	V
Comparator output voltage	V _{COMP1}	T2 DC level for V _{IN} = 38 mVp-p and f = 4 MHz.		0.4	0.7	V
	V _{COMP2}	T2 DC level for V _{IN} = 38 mVp-p and f = 4 MHz.	4.5	4.8		V
SW-Tr on resistance during playback	R _{PON17} R _{PON22}	DC difference for 1 and 2 mA current inputs.		4	6	Ω
Trick threshold level	TR1-1	Normal → Trick1 : *1	3.2		5.0	V
	TR1-2	Trick1 → Normal	1.2		2.8	V
	TR2-1	Normal → Trick2 : *1	0.0		0.8	V
	TR2-2	Trick2 → Normal	1.2		2.8	V

Continued on next page.

LA70011, 70011M

Continued from preceding page.

Parameter	Symbol	Conditions	Ratings			Unit
			min	typ	max	
HA playback threshold level	HAP-1	SP → EP : *1	1.7		5.0	V
	HAP-2	EPSP	0.0		1.3	V
SW30 threshold level	SW30-1	Lch → Hch : *1	1.2		5.0	V
	SW30-2	Hch → Lch	0.0		0.8	V
Recording Mode						
Current drain	I _{CCR}	Current input at pin 13.	52	59	66	mA
REC AGC AMP output level	V _{RSP}	Output level for V _{IN} = 400 mVp-p and f = 4 MHz.	127	135	143	mVp-p
	V _{REP}		104	111	119	mVp-p
Intermode gain difference	ΔGVR	VRSP/VREP	1.4	1.7	2.0	dB
REC AGC AMP control characteristic	ΔV _{AGC1-SP} ΔV _{AGC1-EP}	Output level divided by V _{RSP} or V _{REP} for f = 4 MHz and V _{IN} = 700 mVp-p.		0.5	1.0	dB
	ΔV _{AGC2-SP} ΔV _{AGC2-EP}	Output level divided by V _{RSP} or V _{REP} for f = 4 MHz and V _{IN} = 100 mVp-p.	-1.0	-0.5		dB
REC AGC AMP frequency characteristic	ΔV _{FRS} ΔV _{FRE}	Ratio of f = 7 MHz output to f = 1 MHz output for V _{IN} = 400 mVp-p. *2	-1	0	+1	dB
REC AGC AMP secondary primary distortion	ΔV _{HDRS} ΔV _{HDRE}	Ratio of the 8 MHz (secondary) component of the output to its 4 MHz (primary) component for V _{IN} = 400 mVp-p and f = 4 MHz.		-45	-40	dB
REC AGC AMP maximum output level	ΔV _{MOSP} ΔV _{MOEP}	Output level, for f = 4 MHz, at which the secondary distortion is -35 dB.	20	22		mApp
REC AGC AMP muting attenuation	ΔV _{MRS} ΔV _{MRE}	Output level divided by V _{RSP} or V _{REP} for f = 4 MHz and V _{IN} = 400 mVp-p.		-45	-40	dB
REC AGC AMP cross modulation relative level	ΔV _{CYS} ΔV _{CYE}	Output ratio (4M ± 629k)/4M for V _{IN} = 400 mVp-p and f = 4 MHz at T9A and V _{IN} = 2.4 Vp-p and f = 629 kHz at T10A.		-45	-40	dB
HA REC threshold level	HAR-1	SP → EP : *1	1.7		5.0	V
	HAR-2	EP → SP	0.0		1.3	V
REC MUTE threshold level	MUTE-1	MUTE OFF → MUTE ON *1	1.2		2.8	V
	MUTE-2	MUTE ON → MUTE OFF	3.2		5.0	V
REC PB threshold level	PB-REC	PB → REC *1	1.2		5.0	V
	REC-PB	REC → PB	0.0		0.8	V

Notes: * Before measuring the items under Playback Mode, input a 0 to 5.0 V trigger pulse to T5 (H-SYNC), the pin from which the LA70011 takes its T3 (HA) control switch timing.

* The resistance between pins 13 and 14 must be accurate to within 1.0%.

*1. These are voltage application points.

*2. Apply a DC voltage of approximately 1.8 V to the AGC wave detector filter pin (pin 15) to fix the AGC amplifier gain.

*3. Apply a DC voltage to the REC-CUR-Adj pin (pin 12) and adjust the output level.

LA70011, 70011M

Pin Descriptions

Pin Number	Pin Name	Standard DC Voltage (V)		Equivalent Circuit	Notes					
1	TRICK-H			<p style="text-align: right;">A09418</p>	<table border="1"> <tr> <td>Trick1</td> <td rowspan="3" style="vertical-align: middle;">3.0 V</td> </tr> <tr> <td>NORMAL</td> </tr> <tr> <td>Trick2</td> <td>1.0 V</td> </tr> </table>	Trick1	3.0 V	NORMAL	Trick2	1.0 V
Trick1	3.0 V									
NORMAL										
Trick2		1.0 V								
2	COMP-OUT	PB	H: min. 4.5 V L: max. 0.7 V	<p style="text-align: right;">A09419</p>	EP > SP ENV High					
3	HA (EP/SP)			<p style="text-align: right;">A09420</p>	<table border="1"> <tr> <td>EP</td> <td rowspan="2" style="vertical-align: middle;">1.0 V</td> </tr> <tr> <td>SP</td> </tr> </table>	EP	1.0 V	SP		
EP	1.0 V									
SP										
4	SW30			<p style="text-align: right;">A09421</p>	<table border="1"> <tr> <td>Hch</td> <td rowspan="2" style="vertical-align: middle;">1.0 V</td> </tr> <tr> <td>Lch</td> </tr> </table>	Hch	1.0 V	Lch		
Hch	1.0 V									
Lch										
5	H-SYNC			<p style="text-align: right;">A09422</p>	<table border="1"> <tr> <td>SYNC H</td> <td rowspan="2" style="vertical-align: middle;">1.5 V</td> </tr> <tr> <td>L</td> </tr> </table>	SYNC H	1.5 V	L		
SYNC H	1.5 V									
L										

Continued on next page.

LA70011, 70011M

Continued from preceding page.

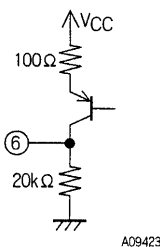
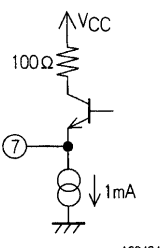
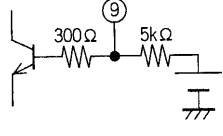
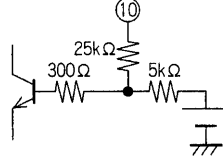
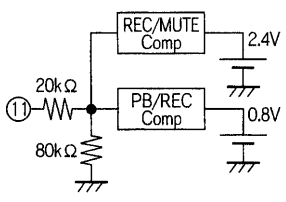
Pin Number	Pin Name	Standard DC Voltage (V)		Equivalent Circuit	Notes					
6	ENVDET-OUT	PB	See relevant documents.	 <p>A09423</p>						
		REC	0							
7	PB-OUT	PB	1.7	 <p>A09424</p>						
		REC	2.1							
8 20	GND									
9	REC-Y-IN	PB	4.0	 <p>A09425</p>						
		REC	3.7							
10	REC-C-IN	PB	4.0	 <p>A09426</p>						
		REC	3.7							
11	REC/MUTE/PB			 <p>A09427</p>	<table border="1" data-bbox="1197 1736 1380 1960"> <tr> <td>REC</td> <td rowspan="2">3.0 V</td> </tr> <tr> <td>REC MUTE</td> </tr> <tr> <td>PB</td> <td>1.0 V</td> </tr> </table>	REC	3.0 V	REC MUTE	PB	1.0 V
REC	3.0 V									
REC MUTE										
PB	1.0 V									

Continued on next page.

LA70011, 70011M

Continued from preceding page.

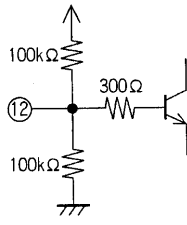
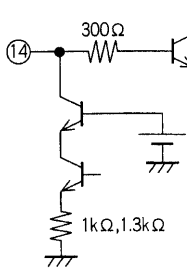
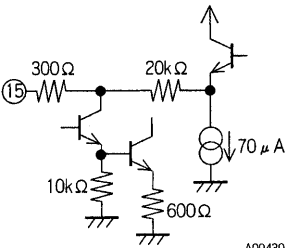
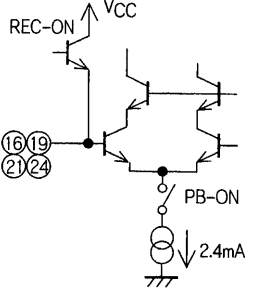
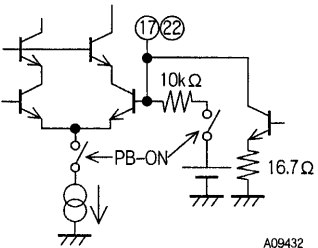
Pin Number	Pin Name	Standard DC Voltage (V)		Equivalent Circuit	Notes
12	REC-CURRENT-ADJ2	PB	2.5 V	 <p>A09428</p>	
		REC	2.5 V		
13	V _{CC}				
14	REC-CURRENT-ADJ1	PB	5.0	 <p>A09429</p>	
		REC	4.5		
15	REC-AGC-FILT	PB	0	 <p>A09430</p>	
		REC	1.6		
16 19 21 24	SP L-IN SP H-IN EP L-IN EP H-IN	PB	2.1	 <p>A09431</p>	
		REC	4.1		
17 22	REC SP OUT EP OUT	PB	2.1	 <p>A09432</p>	
		REC	4.1		

Continued on next page.

LA70011, 70011M

Continued from preceding page.

Pin Number	Pin Name	Standard DC Voltage (V)		Equivalent Circuit	Notes
18 23	PB FILT	PB	0		
		REC	2.5		

Usage Notes

Control Pin Logic

Switching Trick Mode with Pin 1

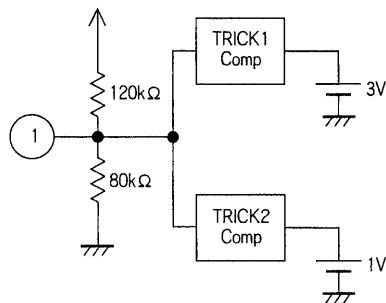

A09434

GND < pin 1 level - DC < 1.0 V: TRICK2
 1.0 V < pin 1 level - DC < 3.0 V: NORMAL
 3.0 V < pin 1 level - DC < 5.0 V: TRICK1

NORMAL Mode

Two channels selected with pin 3 (EP/SP): ON

Envelope comparator: OFF

TRICK1 and TRICK2 Modes

All four channels: ON

Envelope comparator: OFF

Difference between TRICK1 and TRICK2 modes (See the Block Diagram.)

TRICK1 is a special playback mode using the following path

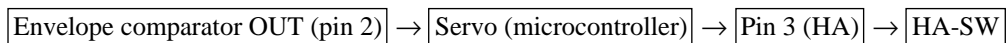

TRICK2 provides SP searching

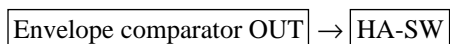

HA-SW (EP/SP mode switch): Pin 3

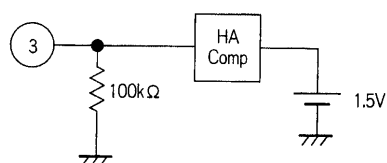

A09435

GND < pin 3 level - DC < 1.5 V: SP mode
 1.5 V < pin 3 level - DC < 5 V: EP mode

LA70011, 70011M

Synchronization of HA Switching Timing during Playback with H-SYNC Signal

During playback, the LA70011's video circuits synchronize the HA-SW switching timing shown in the following figure with the H-SYNC signal from pin 5. (Other EP/SP switching takes place in real time.)

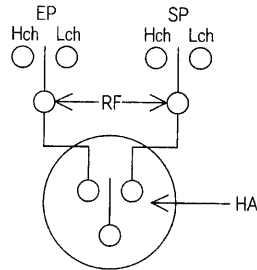

A09436

Comparator Output: Pin 2

EP envelope > SP envelope: High (min. 4.0 V)

EP envelope < SP envelope: Low (max. 0.7 V)

H-SYNC Input: Pin 5

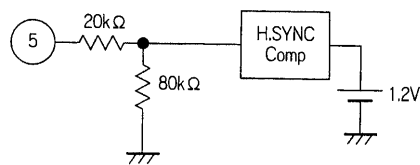

Pin 5 level - DC > 1.5 V: H-SYNC interval

A09437

Playback:

- Determines timing of HA switching (EP/SP)
- Determines timing of special playback

Recording:

- Serves as gate pulse for REC-AGC-AMP SYNC unit

REC/REC-MUTE/PB Switching: Pin 11

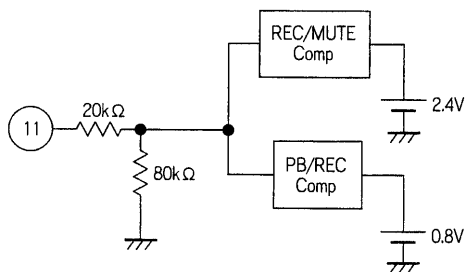

GND < pin 11 level - DC < 1.0 V: PB mode

1.0 V < pin 11 level - DC < 3.0 V: REC mode, REC-MUTE

3.0 V < pin 11 level - DC < 5.0 V: REC mode

A09438

LA70011, 70011M

Envelope Detector Characteristic: Pin 6

The LA70011 includes a built-in playback signal envelope detector circuit for use in automating tracking adjustment.

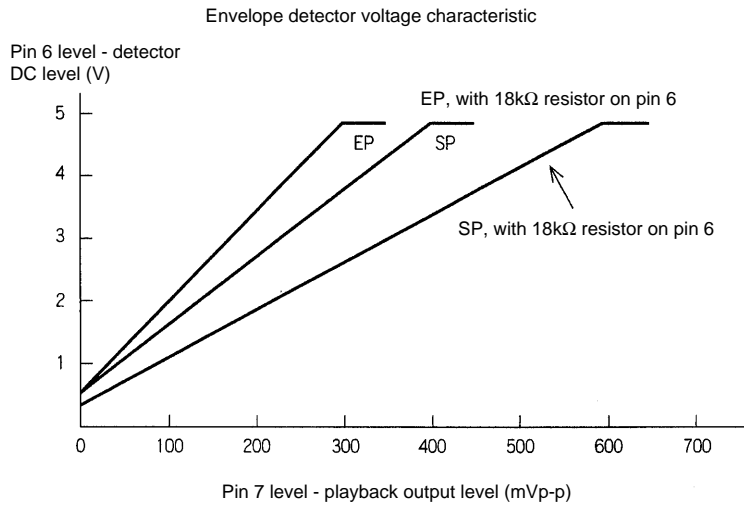

REC AMP Gain Control

The LA70011 eliminates recording current adjustment by adding an automatic gain control circuit to the recording amplifier. It is also possible to change the recording current with the following methods.

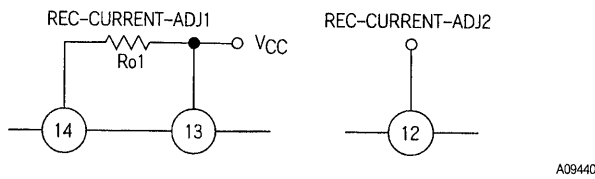

REC-CURRENT-ADJ2 Open

The internal bias forces the DC level at pin 12 to $1/2 V_{CC}$ (that is, approximately 2.5 V), and R_{O1} determines the recording current.

Design values

$R_{O1} = 1.5 \text{ k}\Omega = 16.0 \text{ mA}$ (SP) (per channel)

$R_{O1} = 1.5 \text{ k}\Omega = 12.7 \text{ mA}$ (EP)

REC-CURRENT-ADJ2 Used

Applying a DC control voltage between 1 and 4 V to pin 12 adjusts the figure determined by R_{O1} between -6.0 dB and $+3.5 \text{ dB}$.

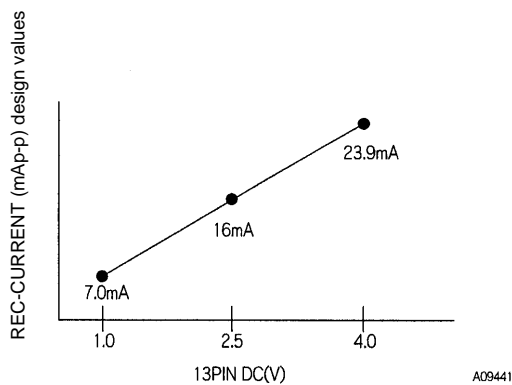

LA70011, 70011M

Note: One possible circuit for applying this voltage is the following, which provides 9 modes between 1 and 4 V.

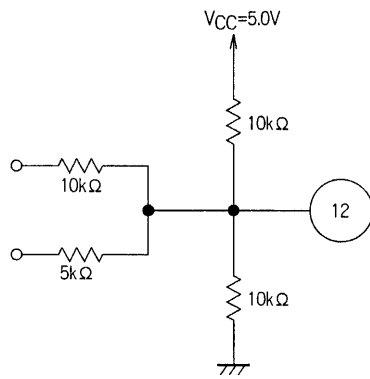

A09442

Block Diagram

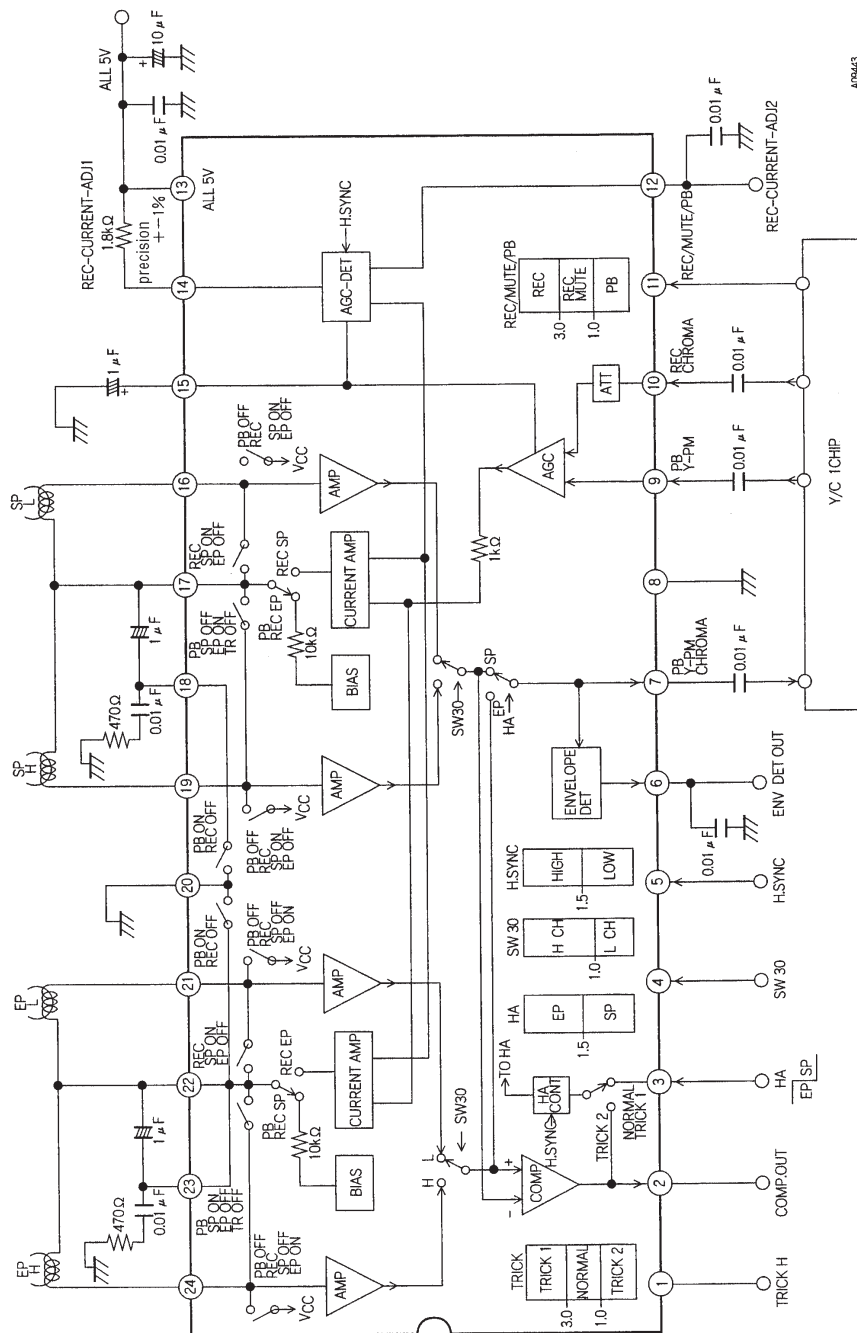

4B943

- No products described or contained herein are intended for use in surgical implants, life-support systems, aerospace equipment, nuclear power control systems, vehicles, disaster/crime-prevention equipment and the like, the failure of which may directly or indirectly cause injury, death or property loss.
- Anyone purchasing any products described or contained herein for an above-mentioned use shall:
 - ① Accept full responsibility and indemnify and defend SANYO ELECTRIC CO., LTD., its affiliates, subsidiaries and distributors and all their officers and employees, jointly and severally, against any and all claims and litigation and all damages, cost and expenses associated with such use:
 - ② Not impose any responsibility for any fault or negligence which may be cited in any such claim or litigation on SANYO ELECTRIC CO., LTD., its affiliates, subsidiaries and distributors or any of their officers and employees jointly or severally.
- Information (including circuit diagrams and circuit parameters) herein is for example only; it is not guaranteed for volume production. SANYO believes information herein is accurate and reliable, but no guarantees are made or implied regarding its use or any infringements of intellectual property rights or other rights of third parties.

This catalog provides information as of February, 1998. Specifications and information herein are subject to change without notice.