



Switched Low Noise Amplifier 800 - 1000 MHz



Features

- High Gain State:
 - Gain: 16dB, Noise Figure: 1.6dB
 - Input IP3: +3dBm (@2.7V, 25mA)
- Low Gain State:
 - Insertion Loss: 5dB, Input IP3: +24dBm
- Single Supply: +2.7 to +5 VDC
- Low Cost MSOP-8 Plastic Package
- Adjustable current: 10 to 30 mA with external resistor

Description

M/A-COM's AM55-0016 is a high dynamic range, switchable low noise amplifier in a low cost, MSOP 8-lead, surface mount, plastic package. The design utilizes a patented switching technique to provide a low insertion loss, high input IP₃ bypass state in parallel with the high gain, low noise state. The LNA employs external input matching to obtain optimum noise figure performance and operating frequency flexibility. The AM55-0016 also features flexible biasing to control the current consumption vs. dynamic range trade-off. Its current can be controlled over a range of 10 mA to 30 mA with an external resistor.

Typical applications include receiver front ends in cellular band CDMA handsets. It is also useful as a switched gain block, buffer or driver in portable cellular systems.

The AM55-0016 is fabricated using a low-cost 0.5-micron gate length GaAs MESFET process. The process features full passivation for increased performance and reliability.

MSOP-8

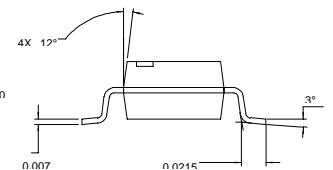
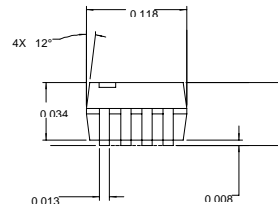
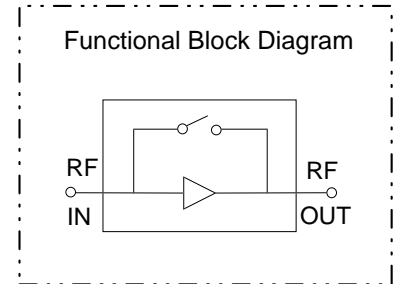
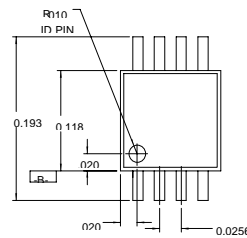

Ordering Information

Part Number	Package
AM55-0016	MSOP 8-Lead Plastic Package
AM55-0016TR	Forward Tape and Reel*
AM55-0016RTR	Reverse Tape and Reel*
AM55-0016SMB	Designer's Kit

* If specific reel size is required, consult factory for part number.

Electrical Specifications¹ T_A = +25°C, Z₀=50Ω, F=881 MHz, P_{IN}= -30 dBm, V_{DD}=2.7 V, I_{DD}=10 mA

Parameter	Test Conditions	Units	Min.	Typ.	Max.
HIGH GAIN STATE , Voltage control = 2.7 volts					
Gain		dB	—	16	—
Noise Figure		dB	—	1.6	1.8
Input IP3	I _{DD} = 10 mA, V _{DD} = 2.7V	dBm	—	-2	—
	I _{DD} = 25 mA, V _{DD} = 2.7V	dBm	—	+3	—
Input VSWR / Output VSWR		—	—	2.0:1	—
Reverse Isolation		dB	—	32	—
LOW GAIN STATE , Voltage control = 0 volts					
Insertion Loss	I _{DD} = 100 μA	dB	—	5	—
Input IP3		dBm	—	+24	—
Input VSWR		—	—	2.3:1	—
Output VSWR		—	—	2.0:1	—

1. Refer to *Typical Performance Data* for performance versus frequency and bias.



Absolute Maximum Ratings¹

Parameter	Absolute Maximum
V _{DD}	+6 VDC
Input Power	0 dBm
Current	30 mA
Channel Temperature ²	+150°C
Operating Temperature	-40°C to +85°C
Storage Temperature	-65°C to +150°C

1. Exceeding any one or combination of these limits may cause permanent damage.
2. Typical thermal resistance (θ_{jc}) = +99°C/W.

External Circuitry Parts List¹

Part	Value	Purpose
C1, C2	1000 pF	Source Bypass
C3, C4	47 pF	By-Pass
C5, C6, C7	10 nF	By-Pass
L1	22 nH	Tuning
RBIAS	see note 2	Source Bias Resistor
U1	UMH9N	Dual Bipolar Transistor

1. All external circuitry parts are readily available, low cost surface mount components (0.040 inches x 0.020 inches or 0.060 inches x 0.030 inches).
2. RBIAS is chosen to set the desired current,
 For: $I_{dd} \sim 10$ mA, R1 = 75 ohms;
 $I_{dd} \sim 20$ mA, R1 = 25 ohms;
 $I_{dd} \sim 30$ mA, R1 = 9 ohms.

Recommended PCB Configuration

Layout View

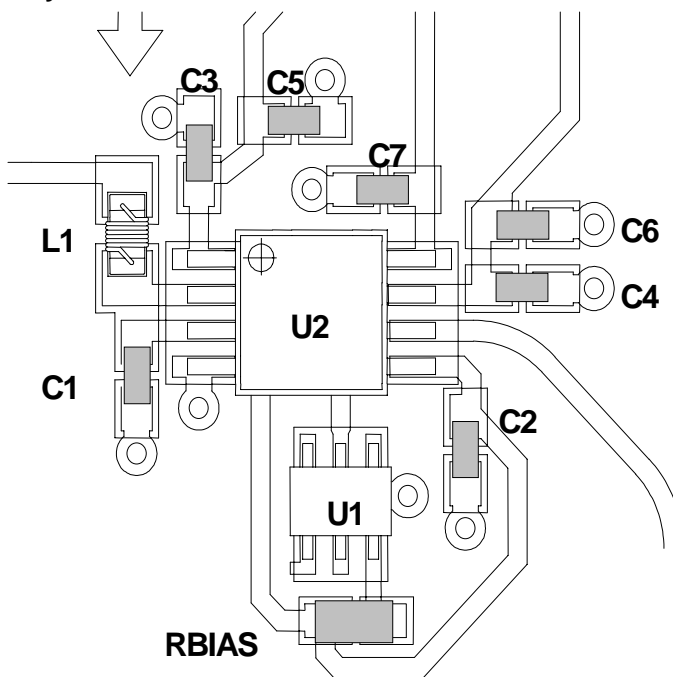

External Circuitry

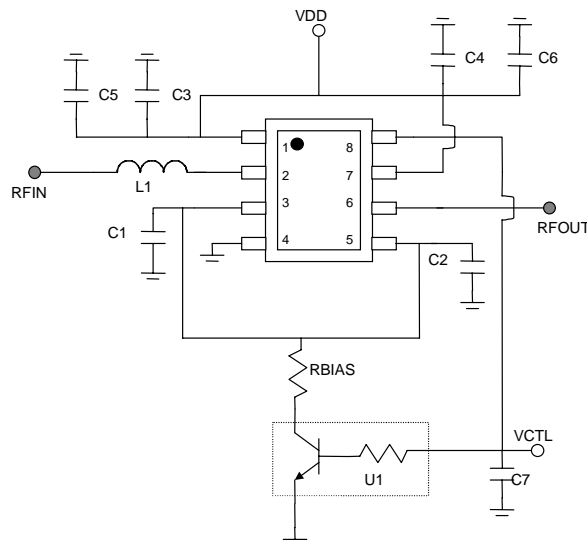

Pin Configuration

Pin No.	Pin Name	Description
1	VDD1	Stage 1 Supply Voltage
2	IN	RF Input
3	VS1	Stage 1 Source
4	GND	RF and DC Ground
5	VS2	Stage 2 Source
6	OUT	RF Output
7	VDD2	Stage 2 Supply Voltage
8	VCTL	Switch Control Voltage

Cross Section View

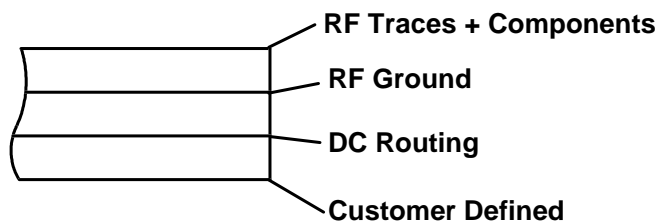

The PCB dielectric between RF traces and RF ground layers should be chosen to reduce RF discontinuities between 50 Ω lines and package pins. M/A-COM recommends an FR-4 dielectric thickness of 0.008" (0.2 mm) yielding a 50 Ω line width of 0.015" (0.38 mm). The recommended metalization thickness is 1 ounce copper.

Typical Performance Data

Test Conditions: $T_A = +25^\circ\text{C}$, $Z_0 = 50\Omega$, $V_{DD} = 2.7\text{V}$, $I_{DD} = 10\text{mA}$ unless otherwise specified.

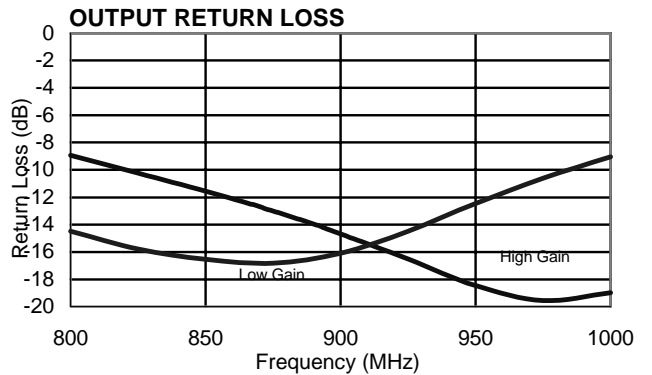
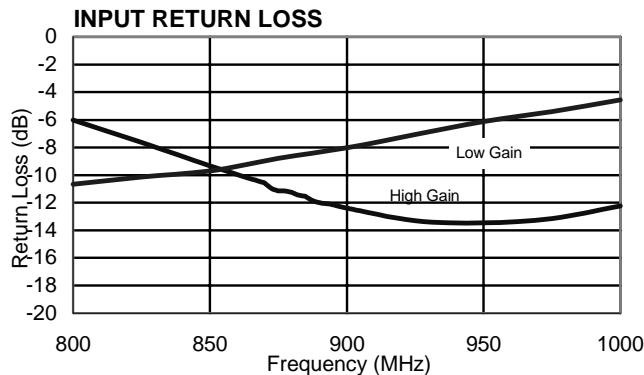
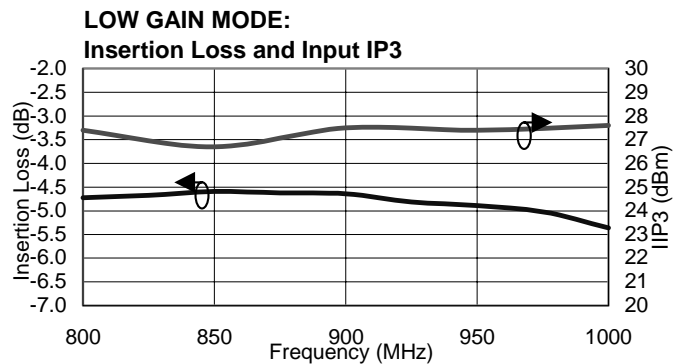
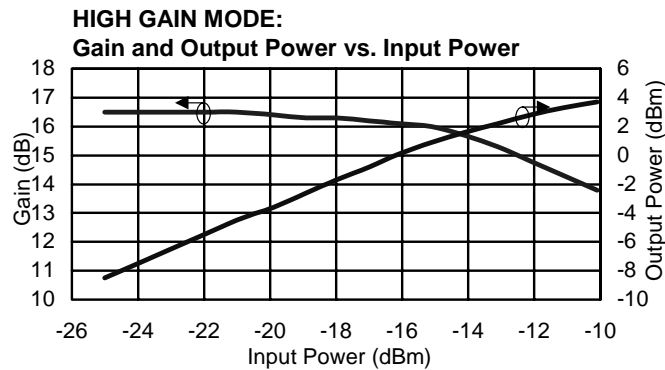
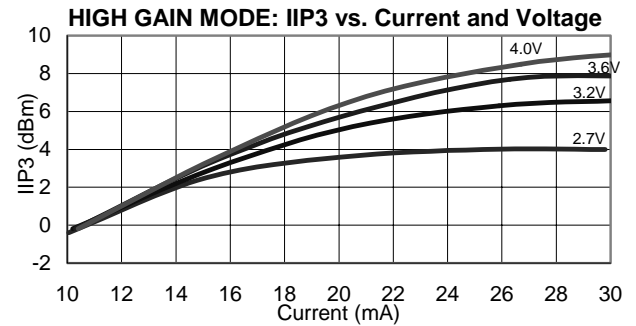
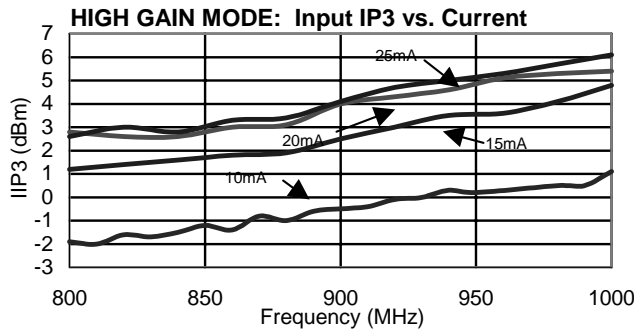
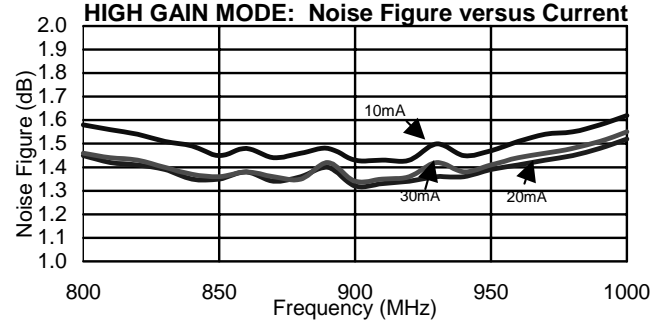
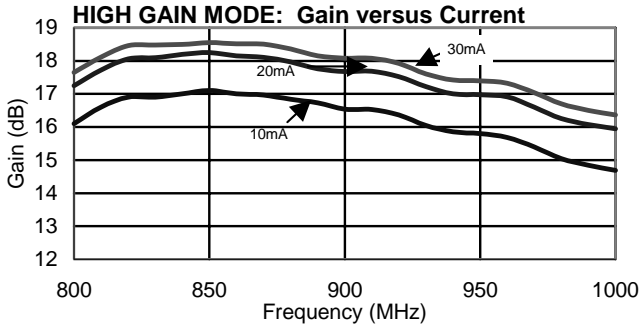

Typical Performance Data (continued)

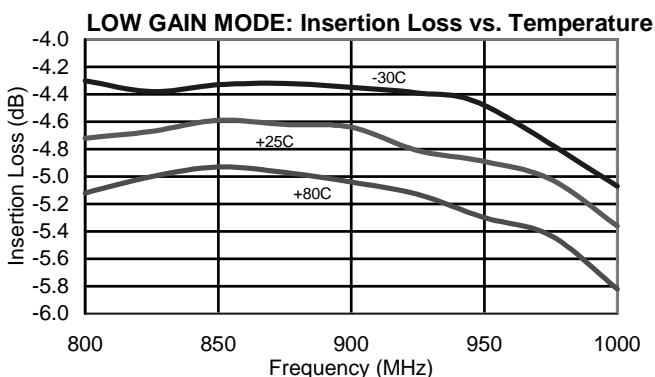
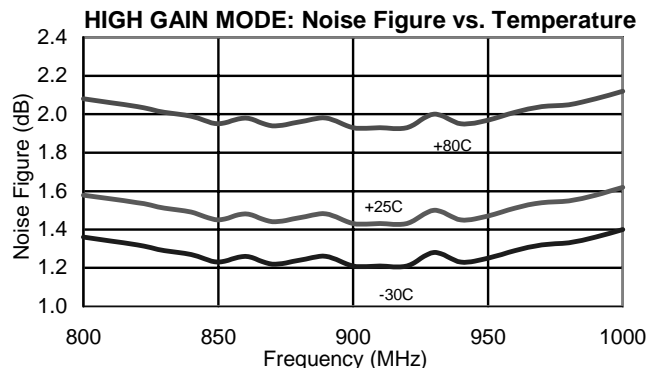
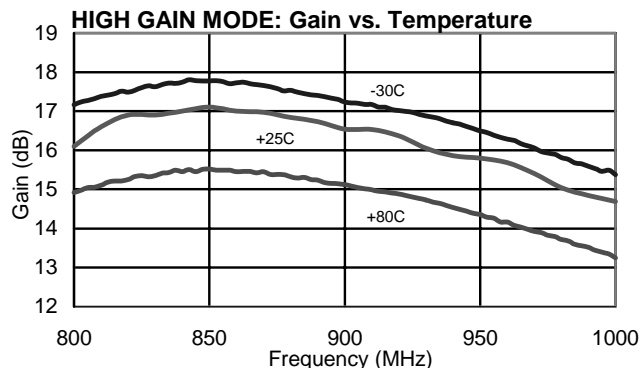

Designer's Kit AM55-0016SMB

The AM55-0016SMB Designer's Kit allows for immediate evaluation of M/A-COM's AM55-0016. The Designer's Kit includes an AM55-0016, an evaluation board and a floppy disk containing typical performance data and a DXF file of the recommended PCB layout. The evaluation board consists of the recommended external surface mount circuitry, RF connectors and a DC multi-pin connector, all mounted to a multi-layer FR-4 PCB. The AM55-0016SMB evaluation PCB is illustrated below with all functional ports labeled.

Evaluation PCB + RF Connector Losses

Port Reference	Approximate RF Loss
RF IN	0.15 dB @ 900 MHz
RF OUT	0.15 dB @ 900 MHz

The DC connector on the Designer's Kit PCB allows convenient DC line access. This is accomplished by one or more of the following methods:

1. A mating female multi-pin connector (Newark Electronics Stock # 46F-4658, not included).
2. Wires soldered to the necessary pins (not included).
3. Clip leads (not included).

AM55-0016 Evaluation Board

