



STN1NC60

N-CHANNEL 600V - 12Ω - 0.3A - SOT-223

PowerMesh™II MOSFET

TYPE	V _{DSS}	R _{DS(on)}	I _D
STN1NC60	600 V	<15Ω	0.3 A

- TYPICAL R_{DS(on)} = 12Ω
- EXTREMELY HIGH dv/dt CAPABILITY
- 100% AVALANCHE TESTED
- NEW HIGH VOLTAGE BENCHMARK
- GATE CHARGE MINIMIZED

DESCRIPTION

The PowerMESH™II is the evolution of the first generation of MESH OVERLAY™. The layout refinements introduced greatly improve the Ron*area figure of merit while keeping the device at the leading edge for what concerns switching speed, gate charge and ruggedness.

APPLICATIONS

- AC ADAPTORS AND BATTERY CHARGERS
- SWITCH MODE POWER SUPPLIES (SMPS)

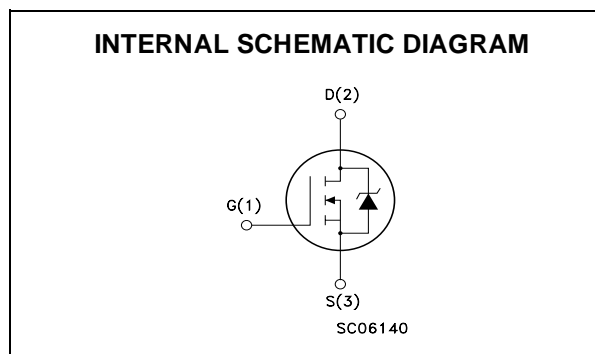
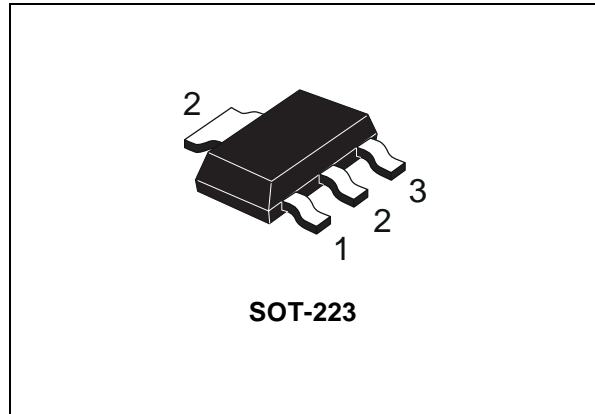

ABSOLUTE MAXIMUM RATINGS

Symbol	Parameter	Value	Unit
V _{DS}	Drain-source Voltage (V _{GS} = 0)	600	V
V _{DGR}	Drain-gate Voltage (R _{GS} = 20 kΩ)	600	V
V _{GS}	Gate- source Voltage	±30	V
I _D	Drain Current (continuous) at T _C = 25°C	0.3	A
I _D	Drain Current (continuous) at T _C = 100°C	0.18	A
I _{DM} ⁽¹⁾	Drain Current (pulsed)	1.2	A
P _{TOT}	Total Dissipation at T _C = 25°C	2.5	W
	Derating Factor	0.02	W/°C
dv/dt	Peak Diode Recovery voltage slope	3	V/ns
T _{stg}	Storage Temperature	-60 to 150	°C
T _j	Max. Operating Junction Temperature	150	°C

(*)Pulse width limited by safe operating area

(1)I_{SD} ≤ 0.3A, di/dt ≤ 100A/μs, V_{DD} ≤ V_{(BR)DSS}, T_j ≤ T_{JMAX}

STN1NC60

THERMAL DATA

Rthj-pcb	Thermal Resistance Junction-PC Board	50	°C/W °C/W °C
Rthj-amb	Thermal Resistance Junction-ambient Max (Surface Mounted)	60	
T _l	Maximum Lead Temperature For Soldering Purpose	260	

AVALANCHE CHARACTERISTICS

Symbol	Parameter	Max Value	Unit
I _{AR}	Avalanche Current, Repetitive or Not-Repetitive (pulse width limited by T _j max)	0.3	A
E _{AS}	Single Pulse Avalanche Energy (starting T _j = 25 °C, I _D = I _{AR} , V _{DD} = 50 V)	60	mJ

ELECTRICAL CHARACTERISTICS (TCASE = 25 °C UNLESS OTHERWISE SPECIFIED)

OFF

Symbol	Parameter	Test Conditions	Min.	Typ.	Max.	Unit
V _{(BR)DSS}	Drain-source Breakdown Voltage	I _D = 250 μA, V _{GS} = 0	600			V
I _{DSS}	Zero Gate Voltage Drain Current (V _{GS} = 0)	V _{DS} = Max Rating V _{DS} = Max Rating, T _C = 125 °C			1 50	μA μA
I _{GSS}	Gate-body Leakage Current (V _{DS} = 0)	V _{GS} = ±30V			±100	nA

ON (1)

Symbol	Parameter	Test Conditions	Min.	Typ.	Max.	Unit
V _{GS(th)}	Gate Threshold Voltage	V _{DS} = V _{GS} , I _D = 250μA	2	3	4	V
R _{DS(on)}	Static Drain-source On Resistance	V _{GS} = 10V, I _D = 0.5 A		12	15	Ω
I _{D(on)}	On State Drain Current	V _{DS} > I _{D(on)} × R _{DS(on)max} , V _{GS} = 10V	1			A

DYNAMIC

Symbol	Parameter	Test Conditions	Min.	Typ.	Max.	Unit
g _{fs} (1)	Forward Transconductance	V _{DS} > I _{D(on)} × R _{DS(on)max} , I _D = 0.5A		0.87		S
C _{iss}	Input Capacitance	V _{DS} = 25V, f = 1 MHz, V _{GS} = 0		108		pF
C _{oss}	Output Capacitance			18		pF
C _{rss}	Reverse Transfer Capacitance			2.5		pF

ELECTRICAL CHARACTERISTICS (CONTINUED)

SWITCHING ON

Symbol	Parameter	Test Conditions	Min.	Typ.	Max.	Unit
$t_{d(on)}$ t_r	Turn-on Delay Time Rise Time	$V_{DD} = 300V, I_D = 0.5A$ $R_G = 4.7\Omega, V_{GS} = 10V$ (see test circuit, Figure 3)		7.2 8		ns ns
Q_g Q_{gs} Q_{gd}	Total Gate Charge Gate-Source Charge Gate-Drain Charge	$V_{DD} = 480V, I_D = 1A,$ $V_{GS} = 10V$		7.3 3.4 2.5	10	nC nC nC

SWITCHING OFF

Symbol	Parameter	Test Conditions	Min.	Typ.	Max.	Unit
$t_{r(Voff)}$ t_f t_c	Off-voltage Rise Time Fall Time Cross-over Time	$V_{DD} = 480V, I_D = 1A,$ $R_G = 4.7\Omega, V_{GS} = 10V$ (see test circuit, Figure 5)		33 11 43		ns ns ns

SOURCE DRAIN DIODE

Symbol	Parameter	Test Conditions	Min.	Typ.	Max.	Unit
I_{SD} $I_{SDM(2)}$	Source-drain Current Source-drain Current (pulsed)				0.3 1.2	A A
$V_{SD(1)}$	Forward On Voltage	$I_{SD} = 0.3 A, V_{GS} = 0$			1.6	V
t_{rr} Q_{rr} I_{RRM}	Reverse Recovery Time Reverse Recovery Charge Reverse Recovery Current	$I_{SD} = 1A, di/dt = 100A/\mu s,$ $V_{DD} = 25V, T_j = 150^\circ C$ (see test circuit, Figure 5)		450 720 3.2		ns μC A

Note: 1. Pulsed: Pulse duration = 300 μs , duty cycle 1.5 %.
2. Pulse width limited by safe operating area.

Safe Operating Area

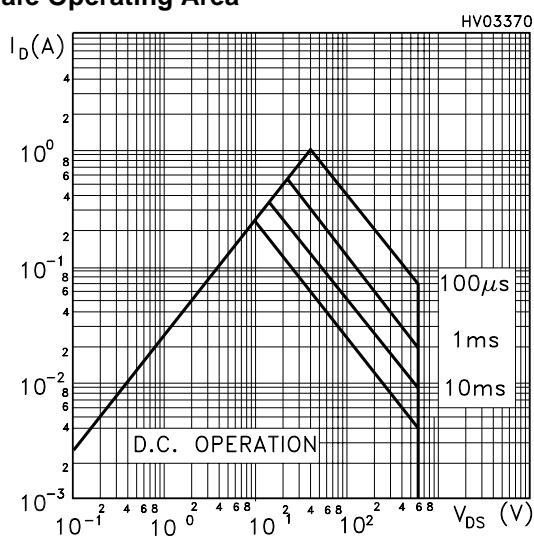

Thermal Impedance

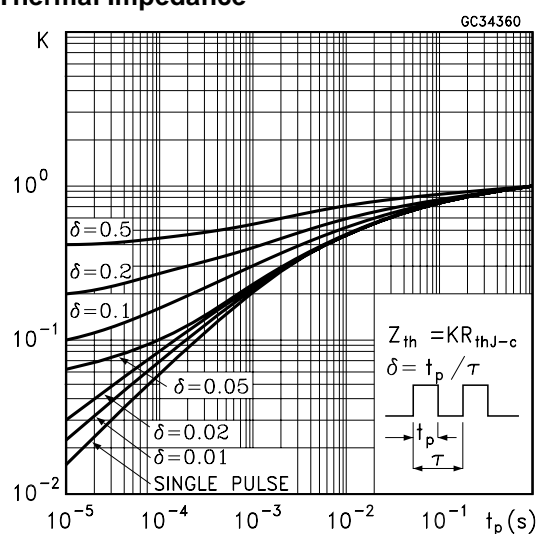

Output Characteristics

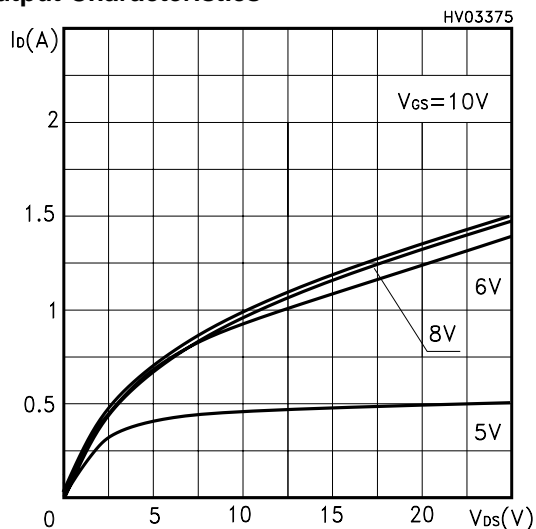

Transfer Characteristics

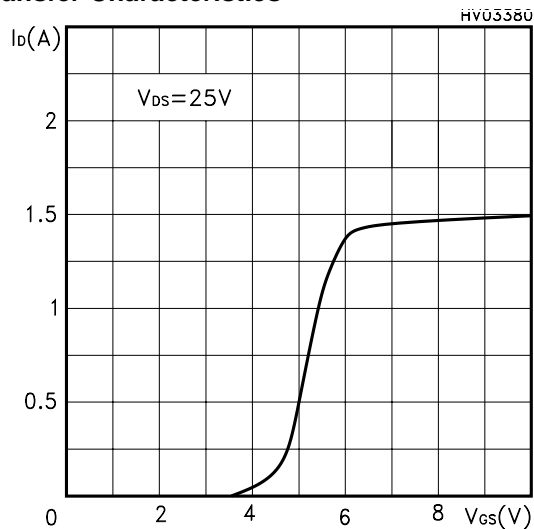

Tranconductance

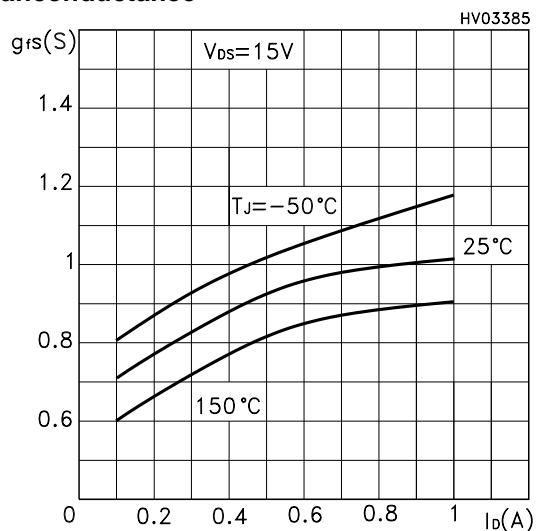

Static Drain-Source On Resistance

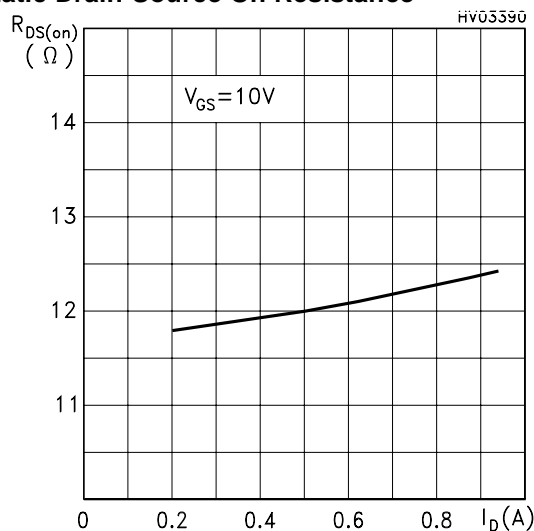

Gate Charge vs Gate-source Voltage

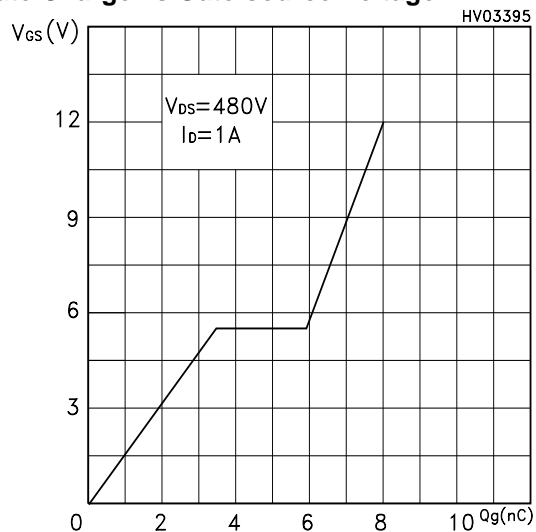

Capacitance Variations

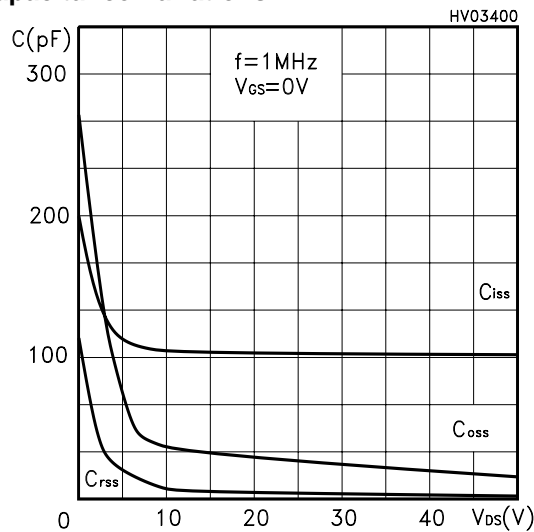

Normalized Gate Threshold Voltage vs Temp.

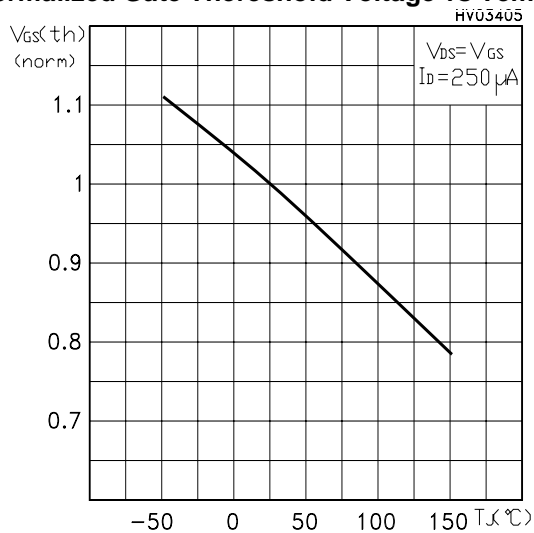

Normalized On Resistance vs Temperature

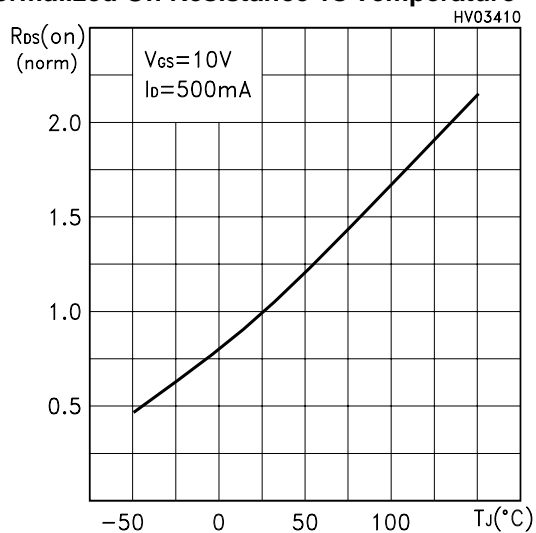

Source-drain Diode Forward Characteristics

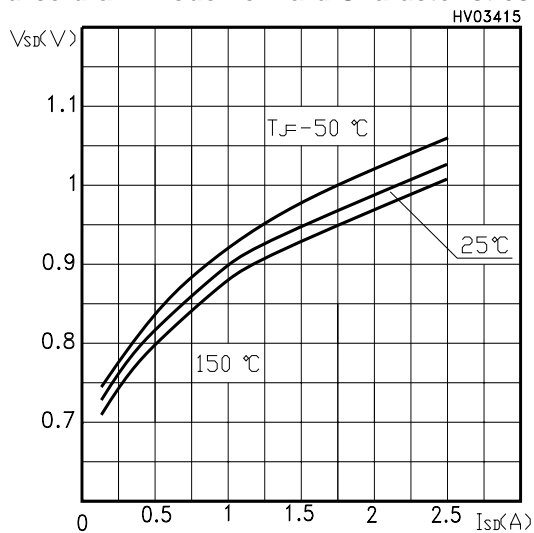

Fig. 1: Unclamped Inductive Load Test Circuit



Fig. 2: Unclamped Inductive Waveform



Fig. 3: Switching Times Test Circuits For Resistive Load



Fig. 4: Gate Charge test Circuit

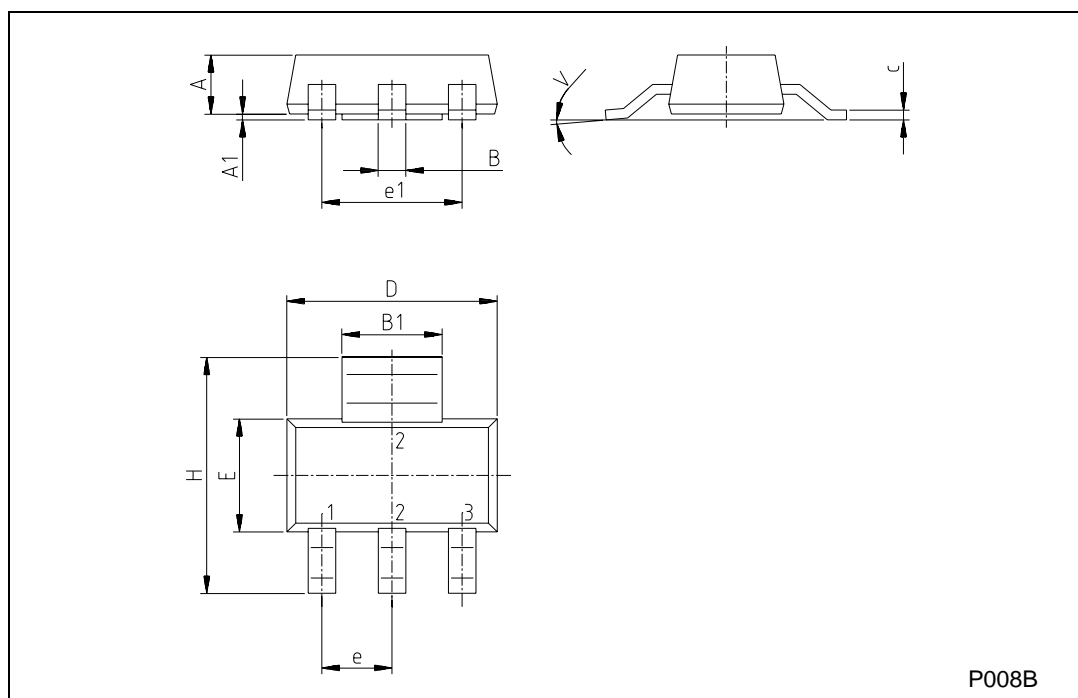

Fig. 5: Test Circuit For Inductive Load Switching And Diode Recovery Times



SOT-223 MECHANICAL DATA

DIM.	mm			inch		
	MIN.	TYP.	MAX.	MIN.	TYP.	MAX.
A			1.80			0.071
B	0.60	0.70	0.80	0.024	0.027	0.031
B1	2.90	3.00	3.10	0.114	0.118	0.122
c	0.24	0.26	0.32	0.009	0.010	0.013
D	6.30	6.50	6.70	0.248	0.256	0.264
e		2.30			0.090	
e1		4.60			0.181	
E	3.30	3.50	3.70	0.130	0.138	0.146
H	6.70	7.00	7.30	0.264	0.276	0.287
V			10°			10°
A1		0.02				



Information furnished is believed to be accurate and reliable. However, STMicroelectronics assumes no responsibility for the consequences of use of such information nor for any infringement of patents or other rights of third parties which may result from its use. No license is granted by implication or otherwise under any patent or patent rights of STMicroelectronics. Specification mentioned in this publication are subject to change without notice. This publication supersedes and replaces all information previously supplied. STMicroelectronics products are not authorized for use as critical components in life support devices or systems without express written approval of STMicroelectronics.

The ST logo is a trademark of STMicroelectronics

© 2000 STMicroelectronics – Printed in Italy – All Rights Reserved
STMicroelectronics GROUP OF COMPANIES

Australia - Brazil - China - Finland - France - Germany - Hong Kong - India - Italy - Japan - Malaysia - Malta - Morocco -
Singapore - Spain - Sweden - Switzerland - United Kingdom - U.S.A.

<http://www.st.com>