

250MHz Video Buffer

The HA-5033 is a unity gain monolithic IC designed for any application requiring a fast, wideband buffer. Featuring a bandwidth of 250MHz and outstanding differential phase/gain characteristics, this high performance voltage follower is an excellent choice for video circuit design. Other features, which include a minimum slew rate of 1000V/μs and high output drive capability, make the HA-5033 applicable for line driver and high speed data conversion circuits.

The high performance of this product is a result of the Intersil Dielectric Isolation process. A major feature of this process is that it produces both PNP and NPN high frequency transistors which makes wide bandwidth designs, such as the HA-5033, practical. Alternative process methods typically produce a lower AC performance.

Ordering Information

PART NUMBER (BRAND)	TEMP. RANGE (°C)	PACKAGE	PKG. NO.
HA2-5033-2	-55 to 125	12 Pin Metal Can	T12.C
HA2-5033-5	0 to 75	12 Pin Metal Can	T12.C
HA3-5033-5	0 to 75	8 Ld PDIP	E8.3
HA4P5033-5	0 to 75	20 Ld PLCC	N20.35
HA9P5033-5 (H50335)	0 to 60 (Note 3)	8 Ld PSOP	M8.15A

Features

- Differential Phase Error 0.02 Degrees
- Differential Gain Error. 0.03%
- High Slew Rate. 1100V/μs
- Wide Bandwidth (Small Signal) 250MHz
- Wide Power Bandwidth DC to 17.5MHz
- Fast Rise Time 3ns
- High Output Drive. ±10V With 100Ω Load
- Wide Power Supply Range. ±5V to ±16V
- Replace Costly Hybrids

Applications

- Video Buffer
- High Frequency Buffer
- Isolation Buffer
- High Speed Line Driver
- Impedance Matching
- Current Boosters
- High Speed A/D Input Buffers
- Related Literature
 - AN548, Designer's Guide for HA-5033

Pinouts

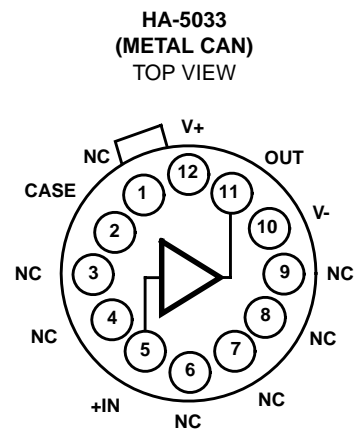
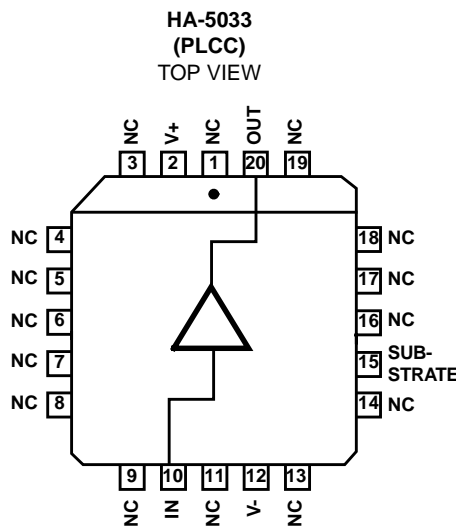
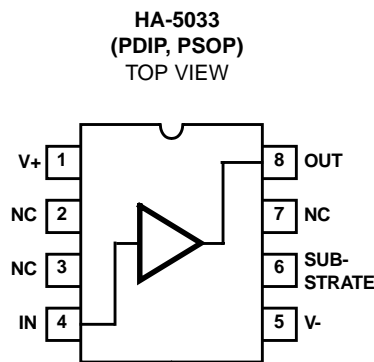

Absolute Maximum Ratings

Voltage Between V+ and V- Pins	40V
DC Input Voltage	V+ to V-
Output Current (Peak) (50ms On/1 Second Off)	±200mA
ESD Rating	
Human Body Model (Per MIL-STD-883 Method 3015.7)	2000V

Operating Conditions

Temperature Ranges	
HA-5033-2	-55°C to 125°C
HA-5033-5 (Note 3)	0°C to 75°C
HA9P5033-5 (Notes 1, 3)	-40°C to 60°C

CAUTION: Stresses above those listed in "Absolute Maximum Ratings" may cause permanent damage to the device. This is a stress only rating and operation of the device at these or any other conditions above those indicated in the operational sections of this specification is not implied.

NOTES:

- Maximum power dissipation, including load conditions, must be designed to maintain the maximum junction temperature below 175°C for the metal can package, and below 150°C for the plastic packages (See Figure 5).
- θ_{JA} is measured with the component mounted on an evaluation PC board in free air.
- Maximum operating temperature in the PSOP package is limited to 60°C, for $V_{SUPPLY} = \pm 12V$ to prevent the junction temperature from exceeding 150°C. The maximum operating temperature may have to be derated further, depending on the output load condition. The operating temperature may be increased if the HA9P5033 is operated at lower V_{SUPPLY} . For example, the quiescent operating temperature may be increased to 75°C by operating at $V_{SUPPLY} \leq \pm 9.7V$. See Figure 5 for more information.
- Direct attach of the PSOP copper slug to copper area on the PCB can reduce the θ_{JA} value to <100°C/W. Consult the Intersil Application Group for more information.

Thermal Information

Thermal Resistance (Typical, Note 2)	θ_{JA} (°C/W)	θ_{JC} (°C/W)
Metal Can Package	65	34
PDIP Package	96	N/A
PSOP Package (Note 4)	129	N/A
PLCC Package	80	N/A
Maximum Junction Temperature (Note 1)	175°C	
Maximum Junction Temperature (Plastic Packages)	150°C	
Maximum Storage Temperature Range	-65°C to 150°C	
Maximum Lead Temperature (Soldering 10s)	300°C (PSOP and PLCC - Lead Tips Only)	

Electrical Specifications $V_{SUPPLY} = \pm 12V, R_S = 50\Omega, R_L = 100\Omega, C_L = 10pF$, Unless Otherwise Specified

PARAMETER	TEST CONDITIONS	TEMP. (°C)	HA-5033-2			HA-5033-5			UNITS
			MIN	TYP	MAX	MIN	TYP	MAX	
INPUT CHARACTERISTICS									
Offset Voltage		25	-	5	15	-	5	15	mV
		Full	-	6	25	-	6	25	mV
Average Offset Voltage Drift		Full	-	33	-	-	33	-	$\mu V/^\circ C$
Bias Current		25	-	20	35	-	20	35	μA
		Full	-	30	50	-	30	50	μA
Input Resistance		25	-	3	-	-	3	-	M Ω
Input Capacitance		25	-	1.6	-	-	1.6	-	pF
Input Noise Voltage	10Hz to 100MHz	25	-	20	-	-	20	-	μV_{P-P}
TRANSFER CHARACTERISTICS									
Voltage Gain	$R_L = 100\Omega$	25	0.93	-	-	0.93	-	-	V/V
	$R_L = 1k\Omega$	25	0.93	0.99	-	0.93	0.99	-	V/V
	$R_L = 100\Omega$	Full	0.92	-	-	0.92	-	-	V/V
-3dB Bandwidth		25	-	250	-	-	250	-	MHz
OUTPUT CHARACTERISTICS									
Output Voltage Swing	$R_L = 100\Omega$	Full	±8	±10	-	±8	±10	-	V
	$R_L = 1k\Omega, V_S = \pm 15V$	Full	±11	±12	-	±11	±12	-	V
Output Current		25	±80	±100	-	±80	±100	-	mA
Output Resistance		25	-	8	-	-	8	-	Ω
Full Power Bandwidth	$V_{OUT} = 1V_{RMS}, R_L = 1k\Omega$	25	-	146	-	-	146	-	MHz
Full Power Bandwidth (Note 5)		25	15.9	17.5	-	15.9	17.5	-	MHz
TRANSIENT RESPONSE									
Rise Time	$V_{OUT} = 500mV$	25	-	4.6	-	-	4.6	-	ns
Propagation Delay		25	-	1	-	-	1	-	ns
Overshoot		25	-	3	-	-	3	-	%
Slew Rate (Note 5)		25	1	1.1	-	1	1.1	-	V/ns

Electrical Specifications $V_{SUPPLY} = \pm 12V, R_S = 50\Omega, R_L = 100\Omega, C_L = 10pF$, Unless Otherwise Specified **(Continued)**

PARAMETER	TEST CONDITIONS	TEMP. (°C)	HA-5033-2			HA-5033-5			UNITS
			MIN	TYP	MAX	MIN	TYP	MAX	
Settling Time to 0.1%		25	-	50	-	-	50	-	ns
Differential Phase Error (Note 6)		25	-	0.02	-	-	0.02	-	Degree
Differential Gain Error (Note 6)		25	-	0.03	-	-	0.03	-	%
POWER SUPPLY CHARACTERISTICS									
Supply Current		25	-	21	25	-	21	25	mA
		Full	-	21	30	-	21	30	mA
Power Supply Rejection Ratio		Full	54	-	-	54	-	-	dB
Harmonic Distortion	$V_{IN} = 1V_{RMS}$ at 100kHz	25	-	<0.1	-	-	<0.1	-	%

NOTES:

- $V_{SUPPLY} = \pm 15V, V_{OUT} = \pm 10V, R_L = 1k\Omega$.
- Differential gain and phase error are nonlinear signal distortions found in video systems and are defined as follows: Differential gain error is defined as the change in amplitude at the color subcarrier frequency as the picture signal is varied from blanking to white level. Differential phase error is defined as the change in the phase of the color subcarrier as the picture signal is varied from blanking to white level. $R_L = 300\Omega$.

Test Circuits and Waveforms

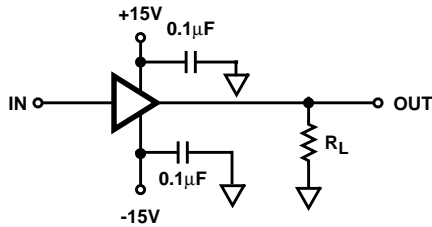

FIGURE 1. SLEW RATE AND SETTLING TIME

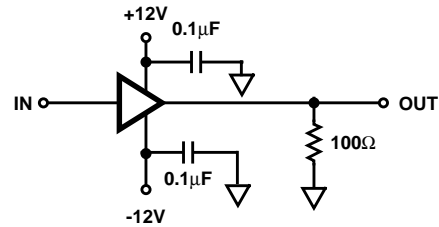

FIGURE 2. TRANSIENT RESPONSE

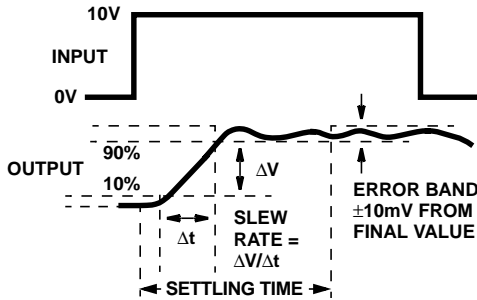

FIGURE 3. SETTLING TIME AND SLEW RATE

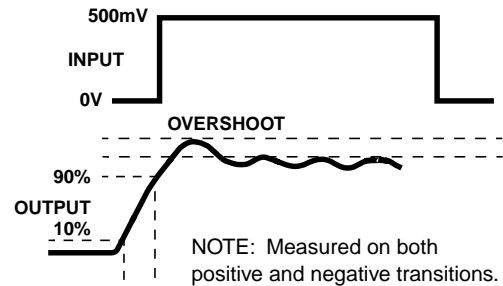
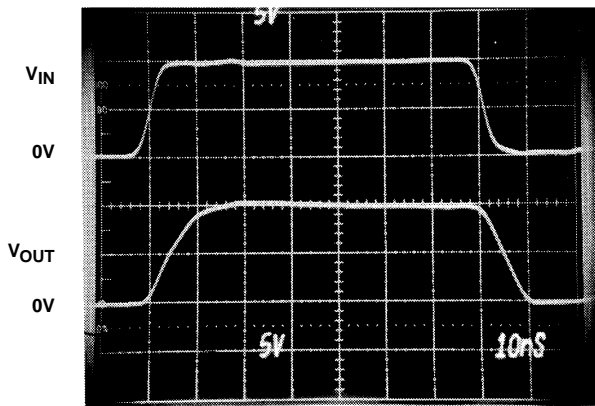
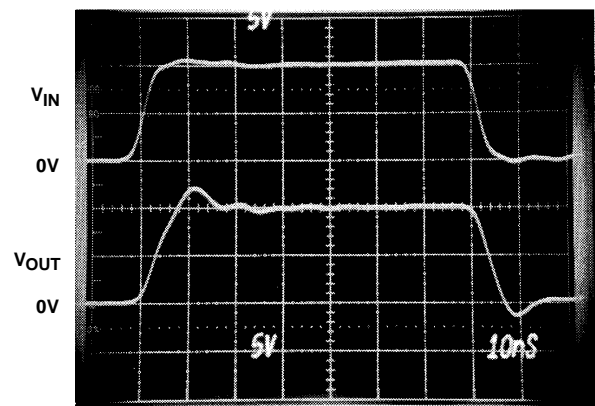

FIGURE 4. RISE TIME AND OVERSHOOT



$T_A = 25^\circ C, R_S = 50\Omega, R_L = 100\Omega$
+10V RESPONSE



$T_A = 25^\circ C, R_S = 50\Omega, R_L = 1k\Omega$
+10V RESPONSE

Test Circuits and Waveforms (Continued)

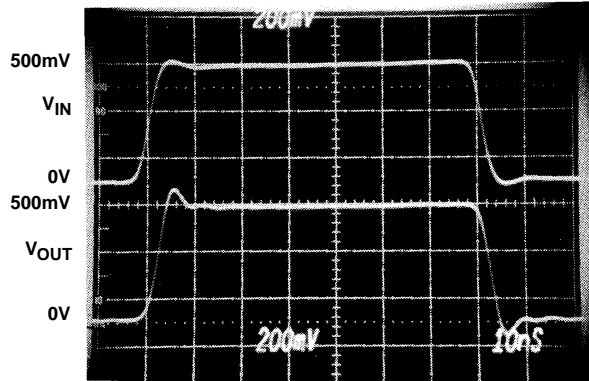

$T_A = 25^\circ\text{C}$, $R_S = 50\Omega$, $R_L = 100\Omega$

PULSE RESPONSE

Schematic Diagram

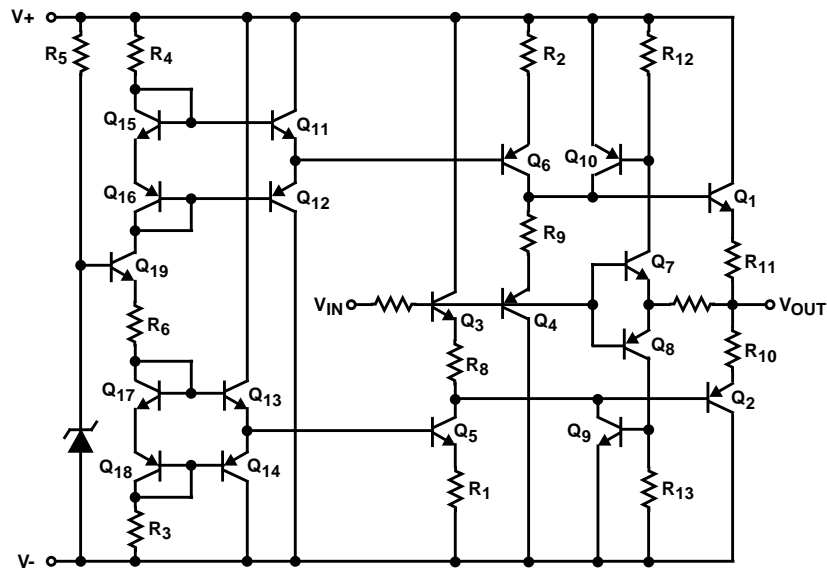

Application Information

Layout Considerations

The wide bandwidth of the HA-5033 necessitates that high frequency circuit layout procedures be followed. Failure to follow these guidelines can result in marginal performance.

Probably the most crucial of the RF/video layout rules is the use of a ground plane. A ground plane provides isolation and minimizes distributed circuit capacitance and inductance which will degrade high frequency performance. This ground plane shielding can also incorporate the metal case of the HA-5033 since pin #2 is internally tied to the package. This feature allows the user to make metal to metal contact between the ground plane and the package, which extends shielding, provides additional heat sinking and eliminates the use of a socket, IC sockets contribute inter-lead capacitance which limits device bandwidth and should be avoided.

For the PDIP, pin 6 can be tied to either supply, grounded, or simply not used. But to optimize device performance and improve isolation, it is recommended that this pin be grounded.

Other considerations are proper power supply bypassing and keeping the input and output connections as short as possible which minimizes distributed capacitance and reduces board space.

Power Supply Decoupling

For optimum device performance, it is recommended that the positive and negative power supplies be bypassed with capacitors to ground. Ceramic capacitors ranging in value from $0.01\mu\text{F}$ to $0.1\mu\text{F}$ will minimize high frequency variations in supply voltage. Solid tantalum capacitors $1\mu\text{F}$ or larger will optimize low frequency performance.

It is also recommended that the bypass capacitors be connected close to the HA-5033 (preferably directly to the supply pins).

Figure 5 is based on:

$$P_{D\text{MAX}} = \frac{T_{J\text{MAX}} - T_A}{\theta_{JA}}$$

Where: $T_{J\text{MAX}}$ = Maximum Junction Temperature of the Device

T_A = Ambient Temperature

θ_{JA} = Junction to Ambient Thermal Resistance

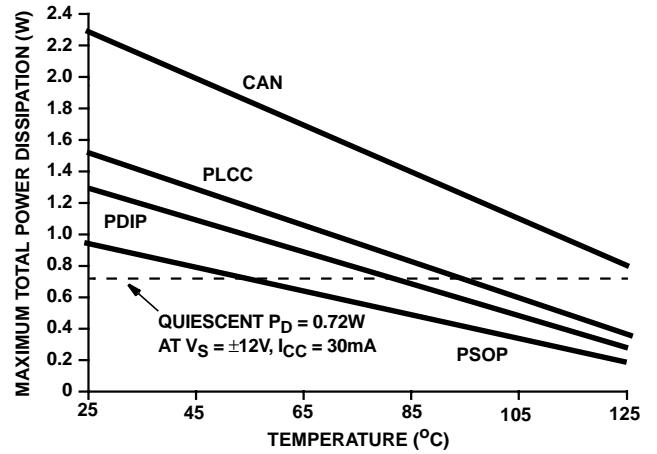

FIGURE 5. MAXIMUM POWER DISSIPATION vs TEMPERATURE

Typical Applications (Also see Application Note AN548)

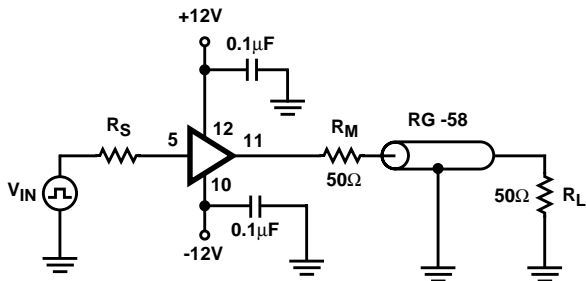

FIGURE 6. VIDEO COAXIAL LINE DRIVER 50Ω SYSTEM

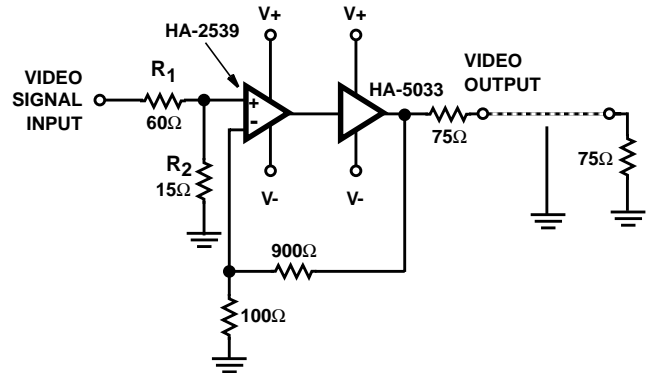
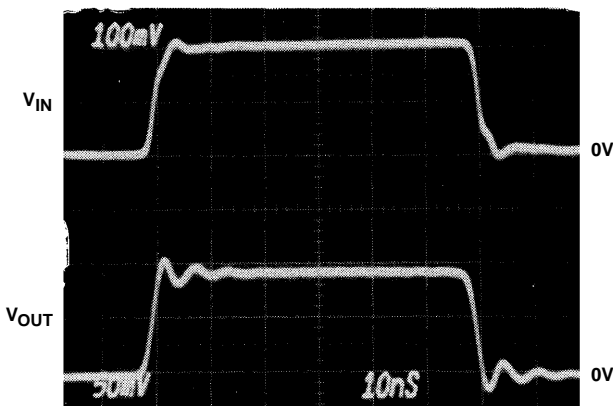

FIGURE 7. VIDEO GAIN BLOCK



$T_A = 25^\circ\text{C}$, $R_S = 50\Omega$, $R_M = R_L = 50\Omega$

$$V_O = V_{IN} \left[\frac{R_L}{R_L + R_M} \right] = \left[\frac{1}{2} \right] V_{IN}$$

POSITIVE PULSE RESPONSE

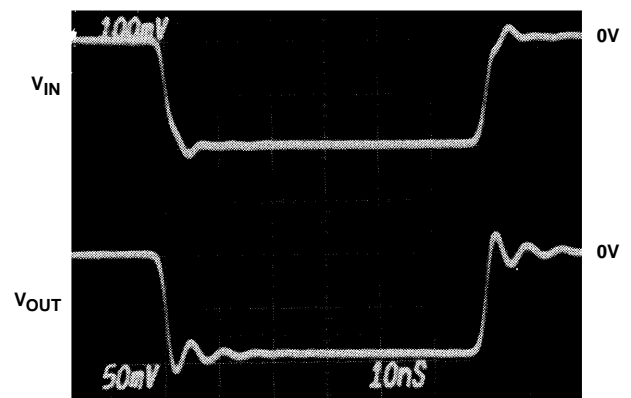

$T_A = 25^\circ\text{C}$, $R_S = 50\Omega$, $R_M = R_L = 50\Omega$

$$V_O = V_{IN} \left[\frac{R_L}{R_L + R_M} \right] = \left[\frac{1}{2} \right] V_{IN}$$

NEGATIVE PULSE RESPONSE

Typical Performance Curves

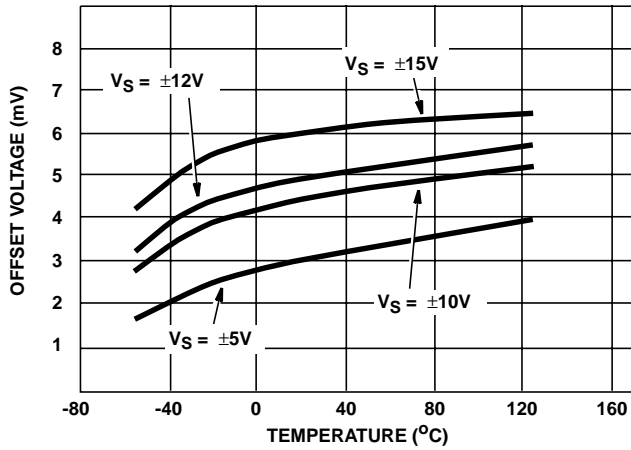

FIGURE 8. INPUT OFFSET VOLTAGE vs TEMPERATURE

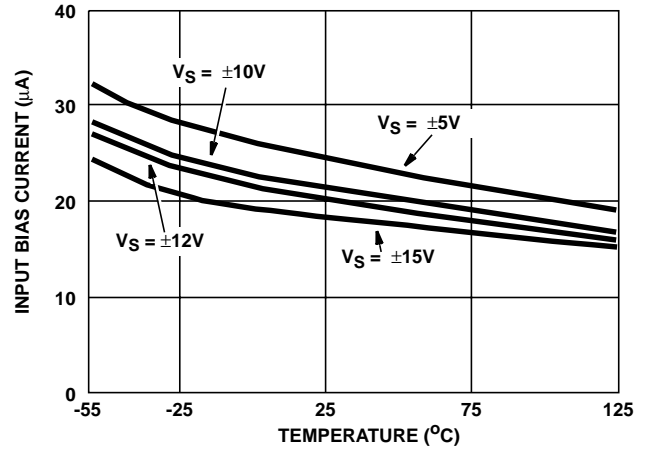

FIGURE 9. INPUT BIAS CURRENT vs TEMPERATURE

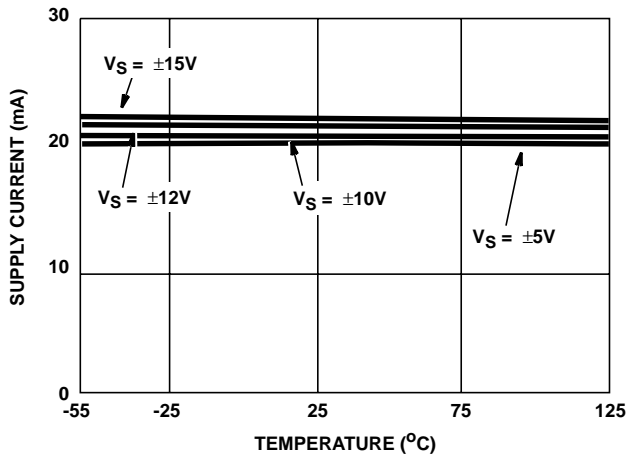

FIGURE 10. SUPPLY CURRENT vs TEMPERATURE

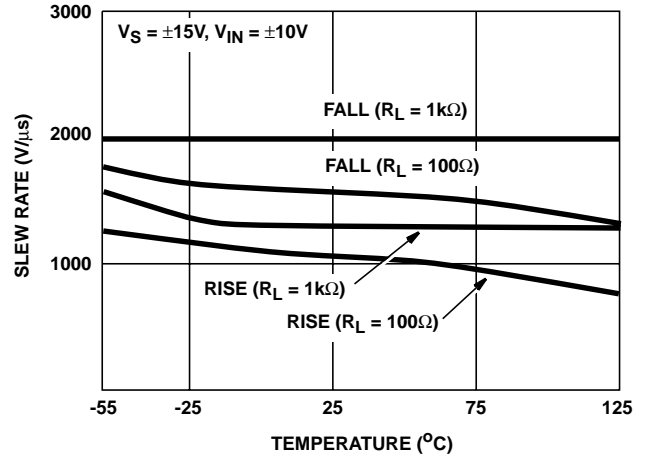

FIGURE 11. SLEW RATE vs TEMPERATURE

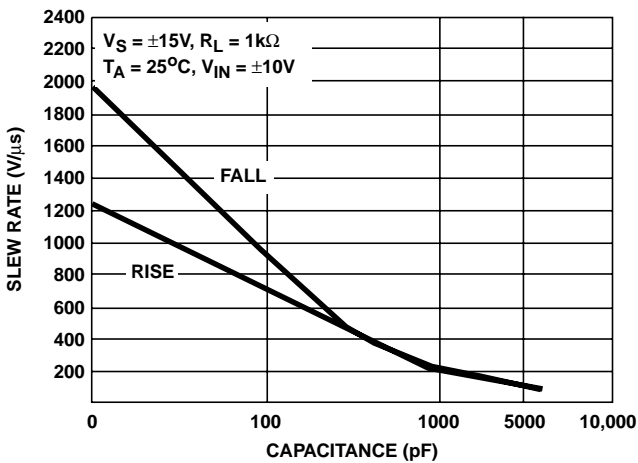

FIGURE 12. SLEW RATE vs LOAD CAPACITANCE

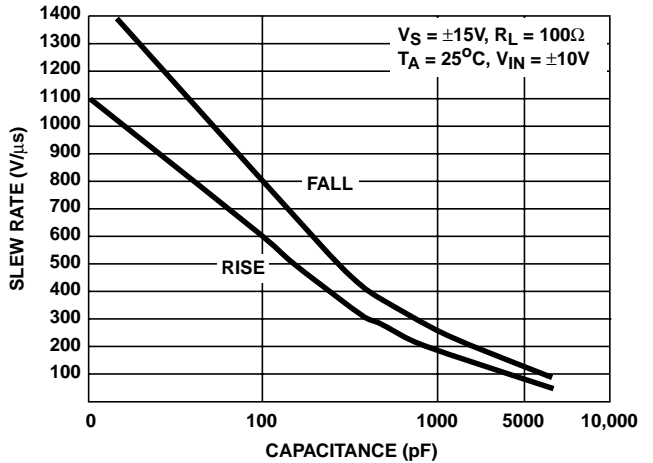

FIGURE 13. SLEW RATE vs LOAD CAPACITANCE

Typical Performance Curves (Continued)

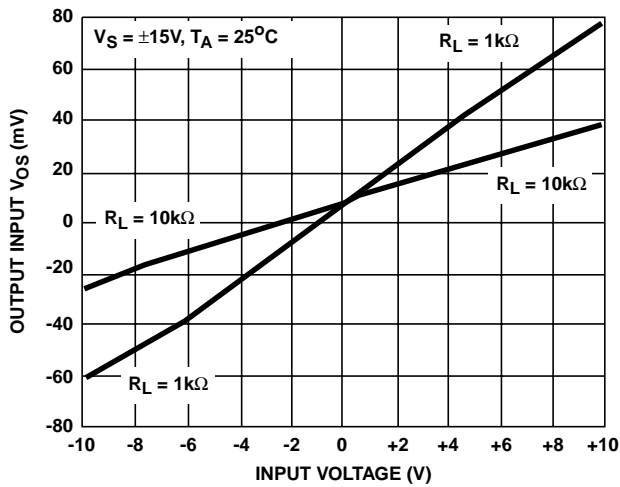

FIGURE 14. GAIN ERROR vs INPUT VOLTAGE

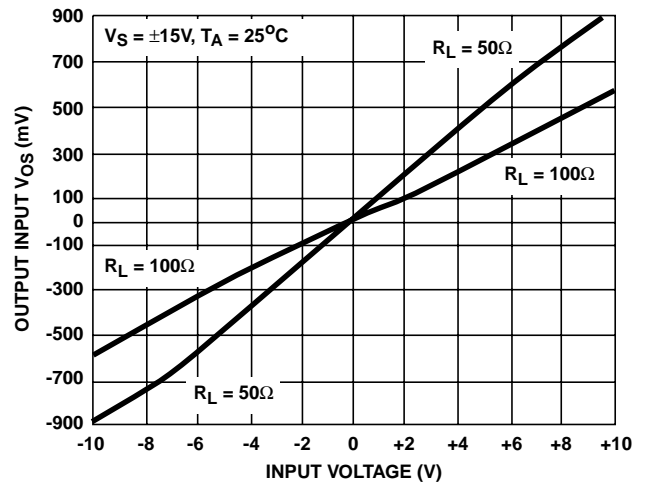

FIGURE 15. GAIN ERROR vs INPUT VOLTAGE

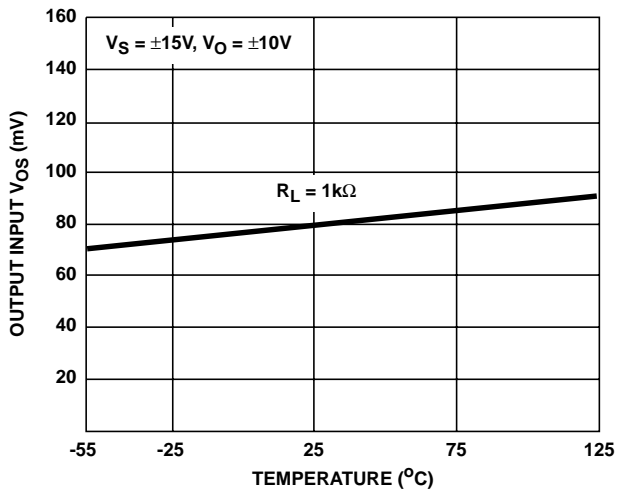

FIGURE 16. GAIN ERROR vs TEMPERATURE

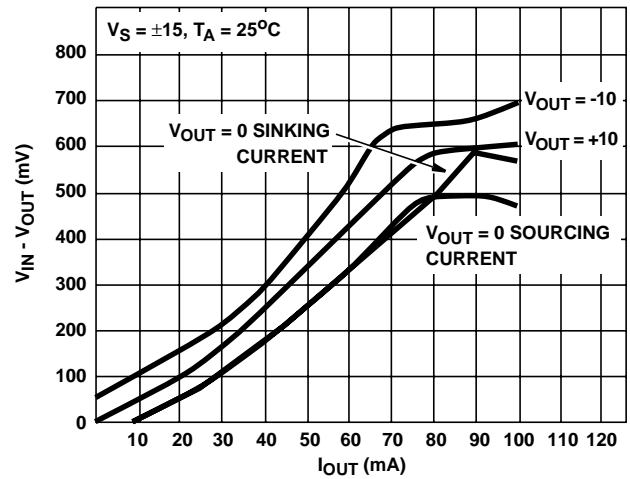

FIGURE 17. $V_{IN} - V_{OUT}$ vs I_{OUT}

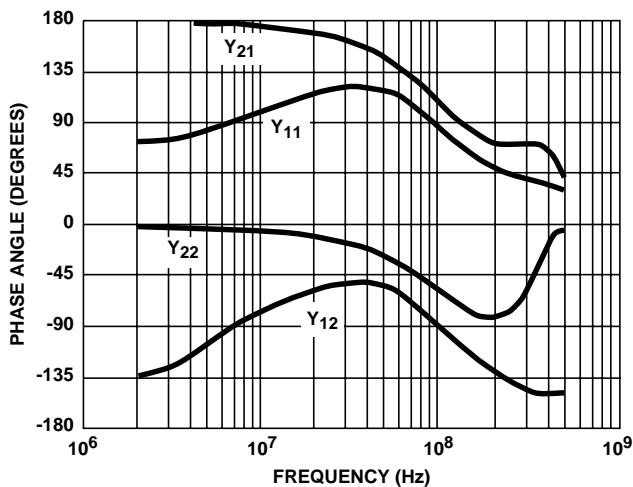

FIGURE 18. Y - PARAMETERS PHASE vs FREQUENCY

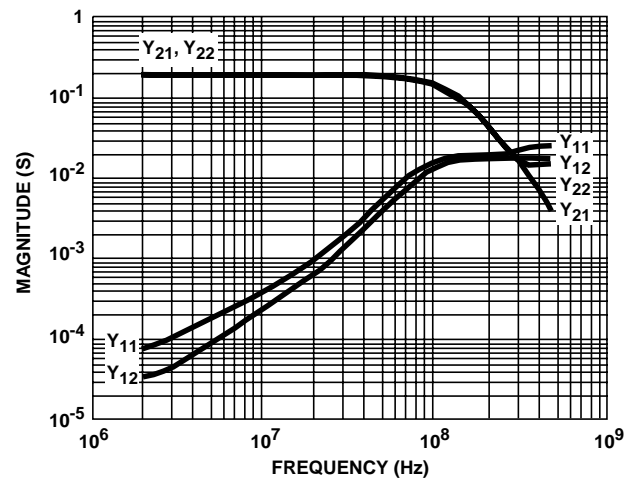

FIGURE 19. Y - PARAMETER MAGNITUDE vs FREQUENCY

Typical Performance Curves (Continued)

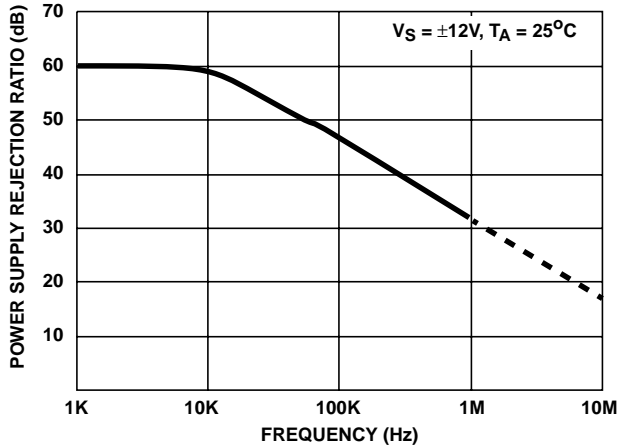

FIGURE 20. POWER SUPPLY REJECTION RATIO vs FREQUENCY

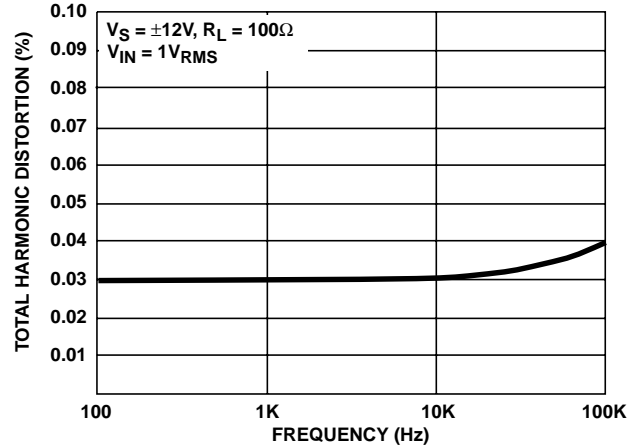

FIGURE 21. TOTAL HARMONIC DISTORTION vs FREQUENCY

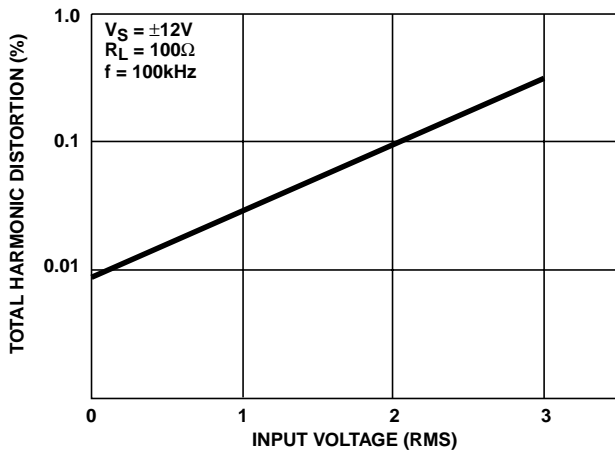

FIGURE 22. TOTAL HARMONIC DISTORTION vs INPUT VOLTAGE

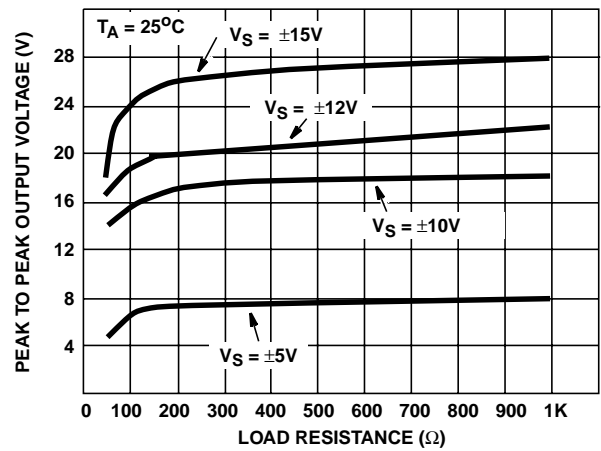

FIGURE 23. OUTPUT VOLTAGE SWING vs LOAD RESISTANCE

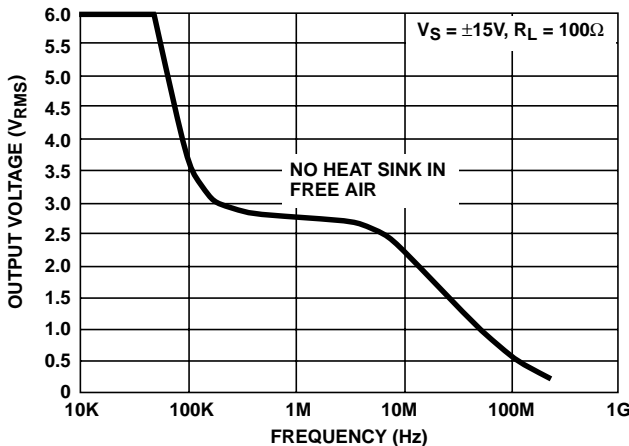

FIGURE 24. OUTPUT SWING vs FREQUENCY (NOTE)

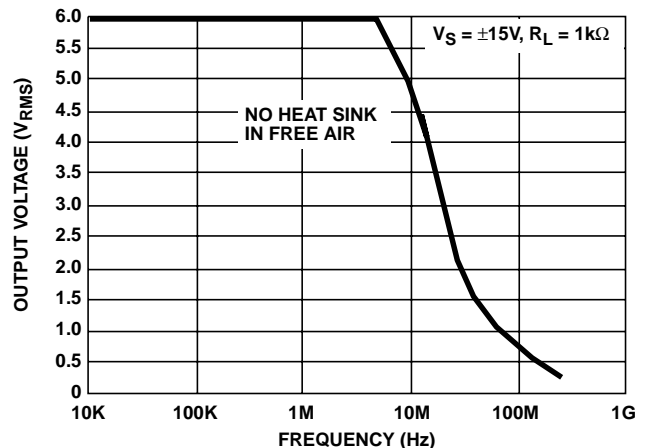

FIGURE 25. OUTPUT SWING vs FREQUENCY (NOTE)

NOTE:

This curve was obtained by noting the output voltage necessary to produce an observable distortion for a given frequency. If higher distortion is acceptable, then a higher output voltage for a given frequency can be obtained. However, operating the HA-5033 with increased distortion (to the right of curve shown), will also be accompanied by an increase in supply current. The resulting increase in chip temperature must be considered and heat sinking will be necessary to prevent thermal runaway. This characteristic is the result of the output transistor operation. If the signal amplitude or signal frequency or both are increased beyond the curve shown, the NPN, PNP output transistors will approach a condition of being simultaneously on. Under this condition, thermal runaway can occur.

Die Characteristics

DIE DIMENSIONS:

51 mils x 67 mils x 19 mils
 1300µm x 1700µm x 483µm

METALLIZATION:

Type: Al, 1% Cu
 Thickness: 16kÅ ±2kÅ

PASSIVATION:

Type: Nitride (Si₃N₄) over Silox (SiO₂, 5% Phos.)
 Silox Thickness: 12kÅ ±2kÅ
 Nitride Thickness: 3.5kÅ ±1.5kÅ

SUBSTRATE POTENTIAL (Powered Up):

Unbiased

TRANSISTOR COUNT:

20

PROCESS:

Bipolar Dielectric Isolation

Metallization Mask Layout

HA-5033

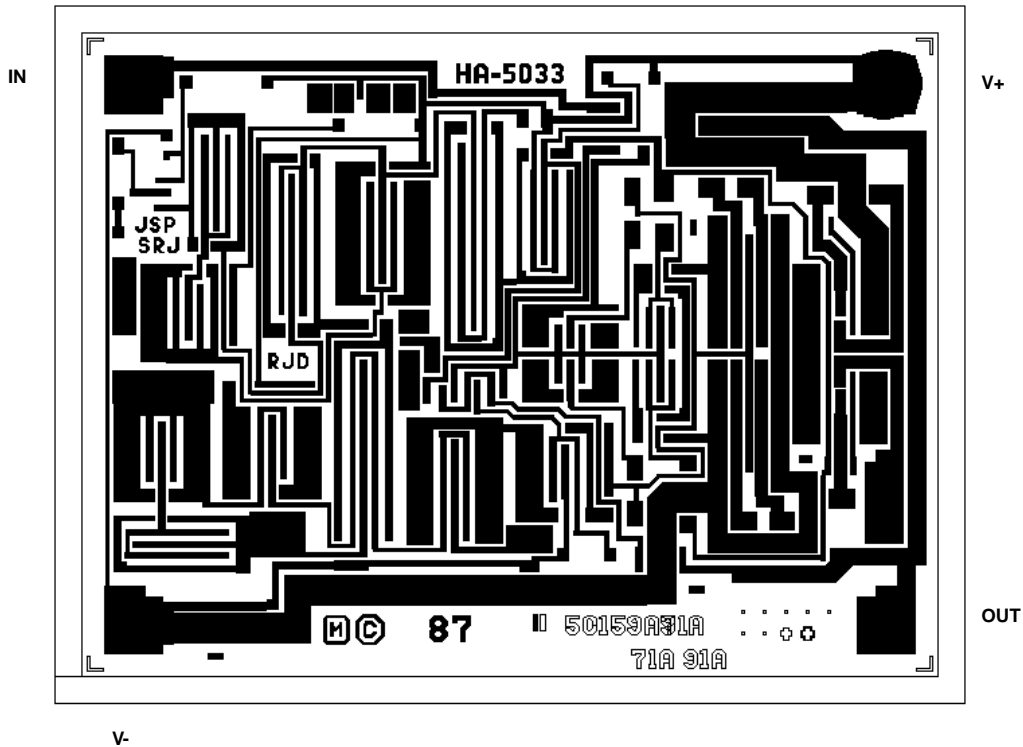

All Intersil semiconductor products are manufactured, assembled and tested under **ISO9000** quality systems certification.

Intersil semiconductor products are sold by description only. Intersil Corporation reserves the right to make changes in circuit design and/or specifications at any time without notice. Accordingly, the reader is cautioned to verify that data sheets are current before placing orders. Information furnished by Intersil is believed to be accurate and reliable. However, no responsibility is assumed by Intersil or its subsidiaries for its use; nor for any infringements of patents or other rights of third parties which may result from its use. No license is granted by implication or otherwise under any patent or patent rights of Intersil or its subsidiaries.

For information regarding Intersil Corporation and its products, see web site <http://www.intersil.com>