

MITSUBISHI THYRISTOR MODULES

TM20RA-M,-H

MEDIUM POWER GENERAL USE
INSULATED TYPE

TM20RA-M,-H



- **IT (AV)** Average on-state current **20A**
- **IF (AV)** Average forward current **20A**
- **VRRM** Repetitive peak reverse voltage
..... **400/800V**
- **VDRM** Repetitive peak off-state voltage
..... **400/800V**
- **MIX DOUBLE ARMS**
- **Insulated Type**
- **UL Recognized**

Yellow Card No. E80276 (N)
File No. E80271

APPLICATION

DC motor control, NC equipment, Inverters, Servo drives, contactless switches,
electric furnace temperature control, light dimmers

OUTLINE DRAWING & CIRCUIT DIAGRAM

Dimensions in mm

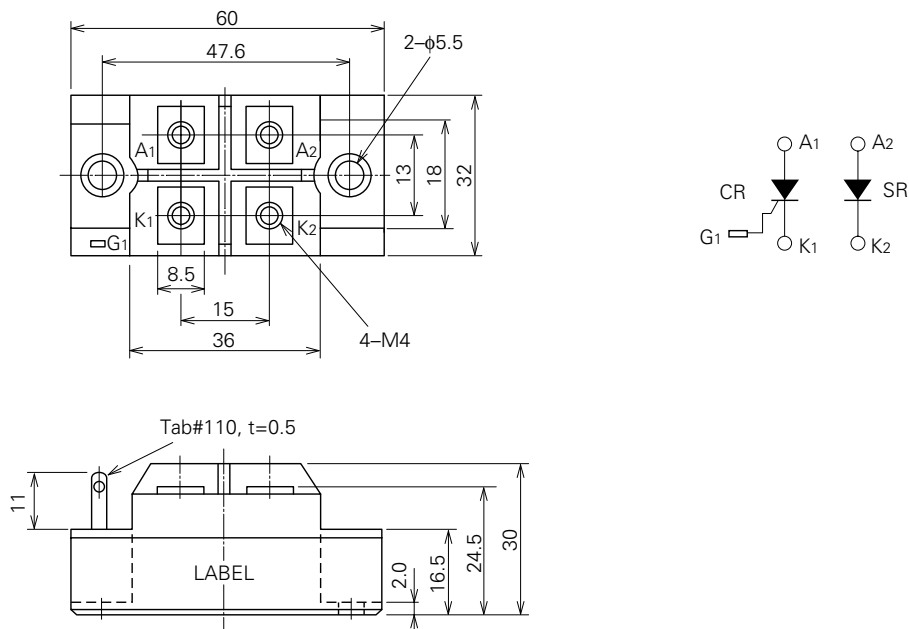

TM20RA-M,-H

**MEDIUM POWER GENERAL USE
INSULATED TYPE**

ABSOLUTE MAXIMUM RATINGS

Symbol	Parameter	Voltage class		Unit
		M	H	
VRRM	Repetitive peak reverse voltage	400	800	V
VRSM	Non-repetitive peak reverse voltage	480	960	V
VR (DC)	DC reverse voltage	320	640	V
VDRM	Repetitive peak off-state voltage	400	800	V
VDSM	Non-repetitive peak off-state voltage	480	960	V
VD (DC)	DC off-state voltage	320	640	V

Symbol	Parameter	Conditions	Ratings	Unit
IT (RMS), IF (RMS)	RMS current		30	A
IT (AV), IF (AV)	Average current	Single-phase, half-wave 180° conduction, Tc=87°C	20	A
ITSM, IFSM	Surge (non-repetitive) current	One half cycle at 60Hz, peak value	400	A
I ² t	I ² t for fusing	Value for one cycle of surge current	6.7 × 10 ²	A ² s
di/dt	Critical rate of rise of on-state current	V _D =1/2V _{DRM} , I _G =0.5A, T _j =125°C	100	A/μs
PGM	Peak gate power dissipation		5.0	W
PG (AV)	Average gate power dissipation		0.5	W
VFGM	Peak gate forward voltage		10	V
VRGM	Peak gate reverse voltage		5.0	V
IFGM	Peak gate forward current		2.0	A
T _j	Junction temperature		-40~125	°C
T _{stg}	Storage temperature		-40~125	°C
V _{iso}	Isolation voltage	Charged part to case	2500	V
—	Mounting torque	Main terminal screw M4	0.98~1.47	N·m
			10~15	kg·cm
		Mounting screw M5	1.47~2.45	N·m
			15~25	kg·cm
—	Weight	Typical value	80	g

ELECTRICAL CHARACTERISTICS

Symbol	Parameter	Test conditions	Limits			Unit
			Min.	Typ.	Max.	
I _{RRM}	Repetitive peak reverse current	T _j =125°C, V _{RRM} applied	—	—	4.0	mA
I _{DRM}	Repetitive peak off-state current	T _j =125°C, V _{DRM} applied	—	—	4.0	mA
V _{TM} , V _{FM}	Forward voltage	T _j =125°C, I _{TM} =I _{FM} =60A, instantaneous meas.	—	—	1.8	V
dv/dt	Critical rate of rise of off-state voltage	T _j =125°C, V _D =2/3V _{DRM}	500	—	—	V/μs
V _{GT}	Gate trigger voltage	T _j =25°C, V _D =6V, R _L =2Ω	—	—	3.0	V
V _{GD}	Gate non-trigger voltage	T _j =125°C, V _D =1/2V _{DRM}	0.25	—	—	V
I _{GT}	Gate trigger current	T _j =25°C, V _D =6V, R _L =2Ω	10	—	50	mA
R _{th (j-c)}	Thermal resistance	Junction to case (per 1/2 module)	—	—	1.0	°C/W
R _{th (c-f)}	Contact thermal resistance	Case to fin, conductive grease applied (per 1/2 module)	—	—	0.25	°C/W
—	Insulation resistance	Measured with a 500V megohmmeter between main terminal and case	10	—	—	MΩ

Note: Items of the above table applies to the Thyristor part and the Diode part as circled in the following tables.

TM20RA-M,-H

MEDIUM POWER GENERAL USE
INSULATED TYPE

MAXIMUM RATINGS

Item	VRRM	VRSM	VR (DC)	VDRM	VD SM	VD (DC)	IT (RMS)	IT (AV)	ITSM	i^2t	di/dt
							IF (RMS)	IF (AV)	IFSM		
Thyristor	○	○	○	○	○	○	○	○	○	○	○
Diode	○	○	○	—	—	—	○	○	○	○	—

Item	PGM	PG (AV)	VFGM	IFGM	T _j	T _{stg}
Thyristor	○	○	○	○	○	○
Diode	—	—	—	—	○	○

ELECTRICAL CHARACTERISTICS

Item	IRRM	IDRM	VTM	dv/dt	VGT	VGD	IGT	R _{th (j-c)}	R _{th (c-f)}
			VFM						
Thyristor	○	○	○	○	○	○	○	○	○
Diode	○	—	○	—	—	—	—	○	○

PERFORMANCE CURVES

MAXIMUM FORWARD CHARACTERISTIC

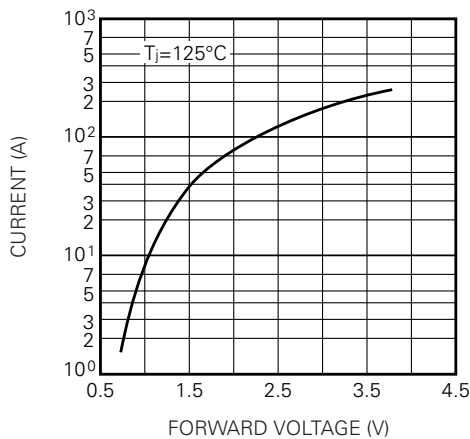

RATED SURGE (NON-REPETITIVE) CURRENT

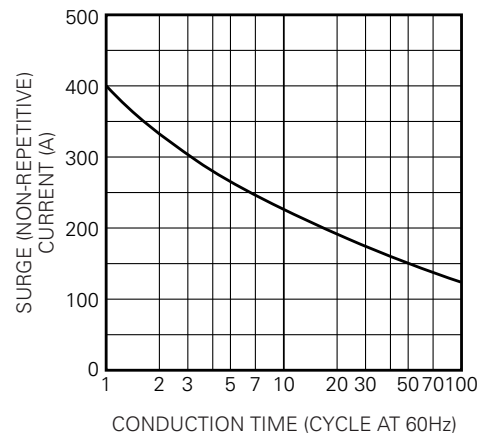

GATE CHARACTERISTICS

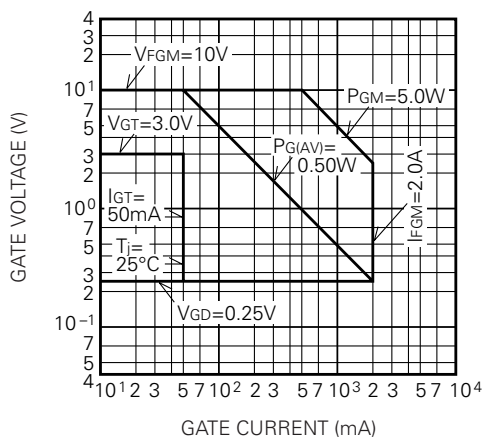

MAXIMUM TRANSIENT THERMAL IMPEDANCE (JUNCTION TO CASE)

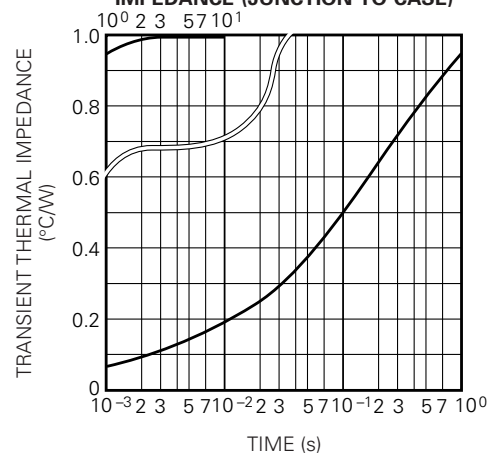

TM20RA-M,-H

MEDIUM POWER GENERAL USE
INSULATED TYPE

MAXIMUM AVERAGE POWER DISSIPATION (SINGLE PHASE HALF WAVE)

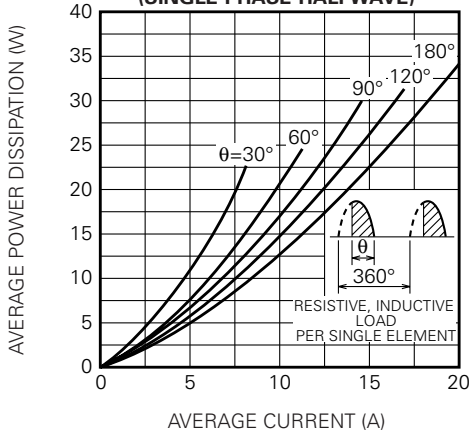

LIMITING VALUE OF THE AVERAGE CURRENT (SINGLE PHASE HALF WAVE)

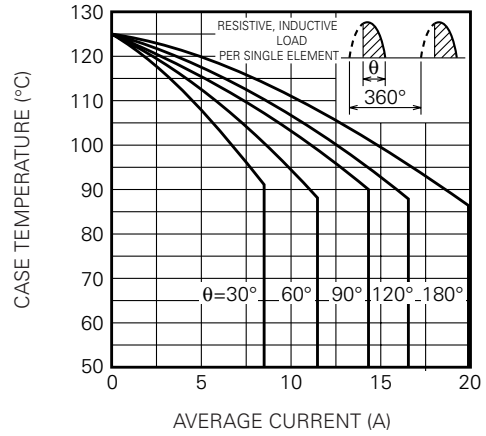

MAXIMUM AVERAGE POWER DISSIPATION (RECTANGULAR WAVE)

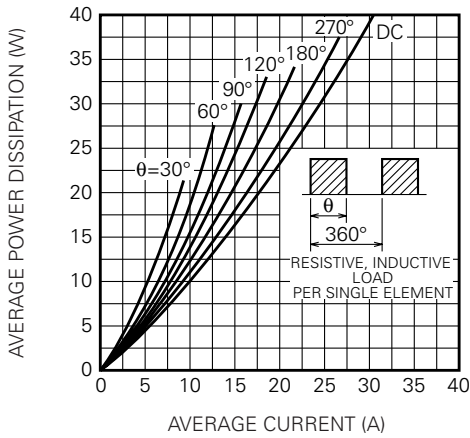

LIMITING VALUE OF THE AVERAGE CURRENT (RECTANGULAR WAVE)

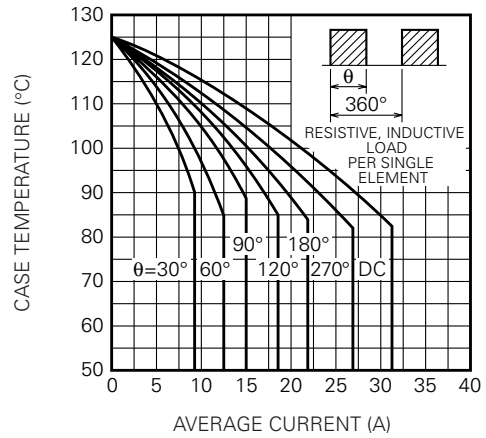

MAXIMUM AVERAGE POWER DISSIPATION (REVERSE-PARALLEL CONNECTION, THREE-PHASE THREE-LINE CONNECTION)

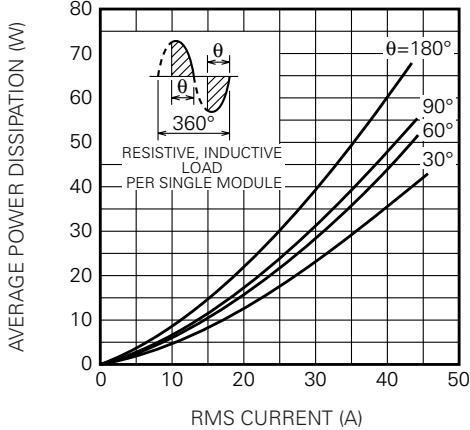

LIMITING VALUE OF THE RMS CURRENT (REVERSE-PARALLEL CONNECTION, THREE-PHASE THREE-LINE CONNECTION)

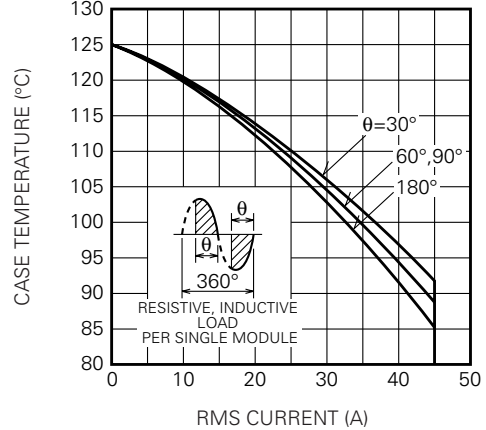

TM20RA-M,-H

MEDIUM POWER GENERAL USE
INSULATED TYPE

**MAXIMUM POWER DISSIPATION
(SINGLE PHASE FULLWAVE RECTIFIED)**

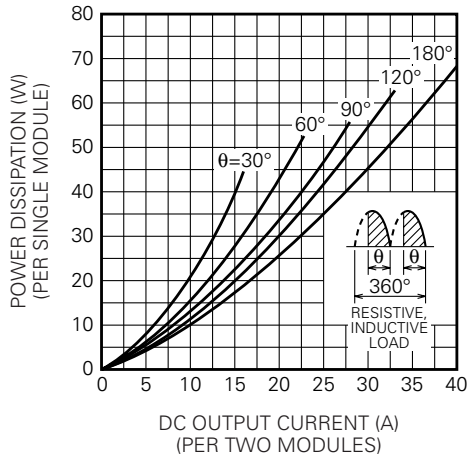

**LIMITING VALUE OF
THE DC OUTPUT CURRENT
(SINGLE PHASE FULLWAVE RECTIFIED)**

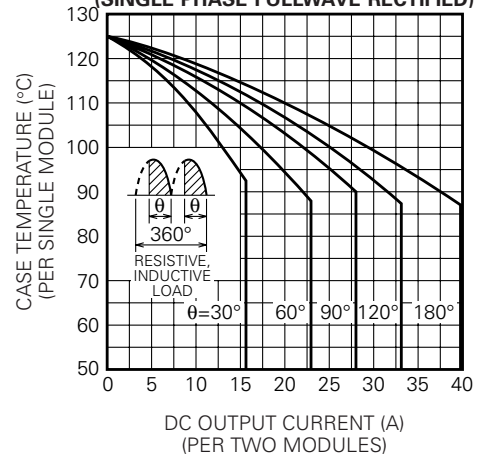

**MAXIMUM POWER DISSIPATION
(THREE-PHASE FULLWAVE RECTIFIED)**

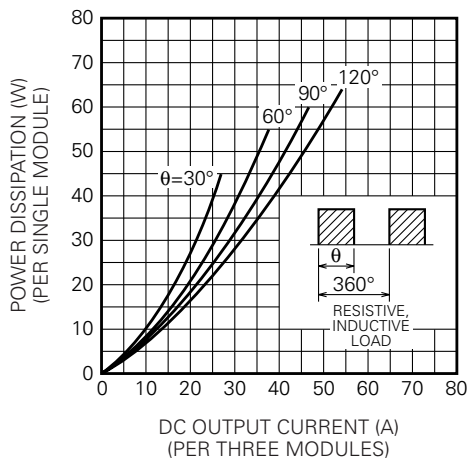

**LIMITING VALUE OF THE DC
OUTPUT CURRENT
(THREE-PHASE FULLWAVE RECTIFIED)**

