



# STGP10NB60SFP

N-CHANNEL 10A - 600V - TO-220FP

PowerMesh™ IGBT

TYPE	V <sub>CES</sub>	V <sub>CE(sat)</sub>	I <sub>C</sub>
STGP10NB60SFP	600	< 1.7 V	10 A

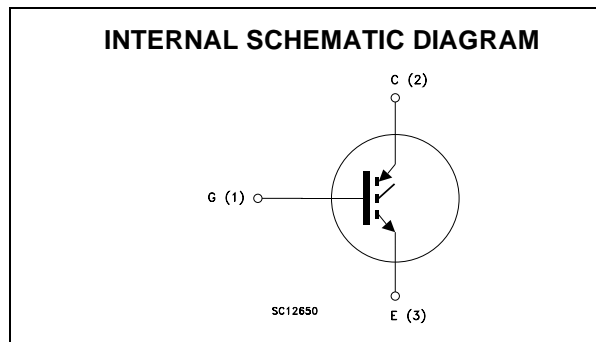
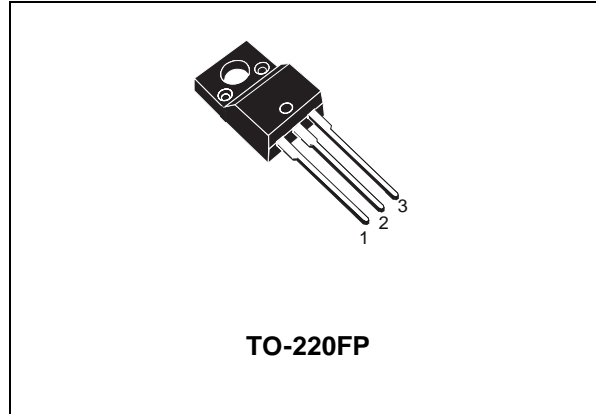
- HIGHT INPUT IMPEDANCE (VOLTAGE DRIVEN)
- LOW ON-VOLTAGE DROP
- HIGH CURRENT CAPABILITY
- OFF LOSSES INCLUDE TAIL CURRENT

## DESCRIPTION

Using the latest high voltage technology based on a patented strip layout, STMicroelectronics has designed an advanced family of IGBTs, the PowerMESH™ IGBTs, with outstanding performances. The suffix "S" identifies a family optimized achieve minimum on-voltage drop for low frequency applications (<1kHz).

## APPLICATIONS

- LIGHT DIMMER
- STATIC RELAYS
- MOTOR CONTROL



## ABSOLUTE MAXIMUM RATINGS

Symbol	Parameter	Value	Unit
V <sub>CES</sub>	Collector-Emitter Voltage (V <sub>GS</sub> = 0)	600	V
V <sub>ECR</sub>	Reverse Battery Protection	20	V
V <sub>GE</sub>	Gate-Emitter Voltage	± 20	V
I <sub>C</sub>	Collector Current (continuous) at T <sub>C</sub> = 25°C	20	A
I <sub>C</sub>	Collector Current (continuous) at T <sub>C</sub> = 100°C	10	A
I <sub>CM</sub> (■)	Collector Current (pulsed)	80	A
P <sub>TOT</sub>	Total Dissipation at T <sub>C</sub> = 25°C	31.5	W
	Derating Factor	0.21	W/°C
T <sub>stg</sub>	Storage Temperature	-65 to 150	°C
T <sub>j</sub>	Max. Operating Junction Temperature	150	°C

(●) Pulse width limited by safe operating area

## STGP10NB60SFP

### THERMAL DATA

Rthj-case	Thermal Resistance Junction-case Max	4.7	°C/W
Rthj-amb	Thermal Resistance Junction-ambient Max	62.5	°C/W
Rthc-sink	Thermal Resistance Case-sink Typ	0.5	°C/W

### ELECTRICAL CHARACTERISTICS (TCASE = 25 °C UNLESS OTHERWISE SPECIFIED)

OFF

Symbol	Parameter	Test Conditions	Min.	Typ.	Max.	Unit
V <sub>BR(CES)</sub>	Collector-Emitter Break-down Voltage	I <sub>C</sub> = 250 μA, V <sub>GE</sub> = 0,	600			V
V <sub>BR(CES)</sub>	Emitter Collector Break-down Voltage	I <sub>C</sub> = 1 mA, V <sub>GE</sub> = 0,	20			V
I <sub>CES</sub>	Collector cut-off Current (V <sub>GE</sub> = 0)	V <sub>CE</sub> = Max Rating, T <sub>J</sub> = 25 °C V <sub>CE</sub> = Max Rating, T <sub>J</sub> = 125 °C			10 100	μA μA
I <sub>GES</sub>	Gate-Emitter Leakage Current (V <sub>CE</sub> = 0)	V <sub>GE</sub> = ± 20V, V <sub>CE</sub> = 0			± 100	nA

ON (1)

Symbol	Parameter	Test Conditions	Min.	Typ.	Max.	Unit
V <sub>GE(th)</sub>	Gate Threshold Voltage	V <sub>CE</sub> = V <sub>GE</sub> , I <sub>C</sub> = 250μA	2.5		5	V
V <sub>CE(SAT)</sub>	Collector-Emitter Saturation Voltage	V <sub>GE</sub> = 15V, I <sub>C</sub> = 5 A, T <sub>J</sub> = 25°C V <sub>GE</sub> = 15V, I <sub>C</sub> = 10 A, T <sub>J</sub> = 25°C V <sub>GE</sub> = 15V, I <sub>C</sub> = 10 A, T <sub>J</sub> = 125°C		1.15 1.35 1.25	1.7	V V V

DYNAMIC

Symbol	Parameter	Test Conditions	Min.	Typ.	Max.	Unit
g <sub>fs</sub>	Forward Transconductance	V <sub>CE</sub> = 25 V, I <sub>C</sub> = 10 A	5			S
C <sub>ies</sub>	Input Capacitance	V <sub>CE</sub> = 25V, f = 1 MHz, V <sub>GE</sub> = 0		610		pF
C <sub>oes</sub>	Output Capacitance			65		pF
C <sub>res</sub>	Reverse Transfer Capacitance			12		pF
Q <sub>g</sub>	Gate Charge	V <sub>CE</sub> = 400V, I <sub>C</sub> = 10 A, V <sub>GE</sub> = 15V		33		nC
I <sub>CL</sub>	Latching Current	V <sub>clamp</sub> = 480V, R <sub>G</sub> = 1kΩ, T <sub>J</sub> = 125°C	20			A

SWITCHING ON

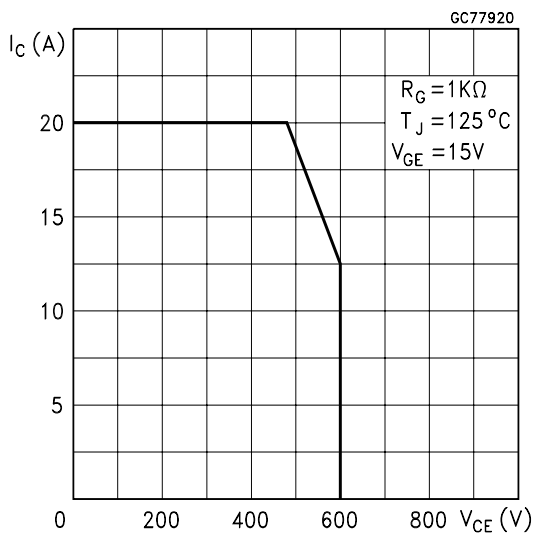
Symbol	Parameter	Test Conditions	Min.	Typ.	Max.	Unit
$t_{d(on)}$	Turn-on Delay Time	$V_{CC} = 480\text{ V}, I_C = 10\text{ A}$ $R_G = 1\text{ K}\Omega, V_{GE} = 15\text{ V}$		0.7		$\mu\text{s}$
$t_r$	Rise Time			0.46		$\mu\text{s}$
$(di/dt)_{on}$	Turn-on Current Slope	$V_{CC} = 480\text{ V}, I_C = 10\text{ A}$		8		$\text{A}/\mu\text{s}$
$E_{on}$	Turn-on Switching Losses	$R_G = 1\text{ K}\Omega, V_{GE} = 15\text{ V}$		0.6		mJ

SWITCHING OFF

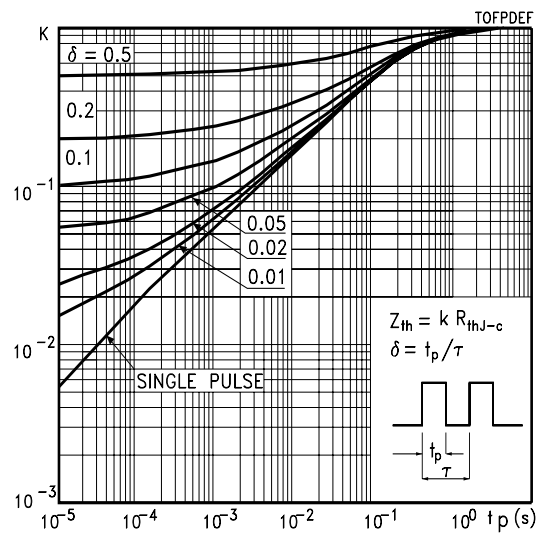
Symbol	Parameter	Test Conditions	Min.	Typ.	Max.	Unit
$t_c$	Cross-over Time	$V_{clamp} = 480\text{ V}, I_C = 10\text{ A},$ $R_{GE} = 1\text{ K}\Omega, V_{GE} = 15\text{ V}$		2.2		$\mu\text{s}$
$t_r(V_{off})$	Off Voltage Rise Time			1.2		$\mu\text{s}$
$t_f$	Fall Time			1.2		$\mu\text{s}$
$E_{off(**)}$	Turn-off Switching Loss			5.0		mJ
$t_c$	Cross-over Time	$V_{clamp} = 480\text{ V}, I_C = 10\text{ A},$ $R_{GE} = 1\text{ K}\Omega, V_{GE} = 15\text{ V}$ $T_J = 125\text{ }^\circ\text{C}$		3.8		$\mu\text{s}$
$t_r(V_{off})$	Off Voltage Rise Time			1.2		$\mu\text{s}$
$t_f$	Fall Time			1.9		$\mu\text{s}$
$E_{off(**)}$	Turn-off Switching Loss			8.0		mJ

(●) Pulsed: Pulse duration = 300  $\mu\text{s}$ , duty cycle 1.5 %.  
 (1) Pulse width limited by max. junction temperature.  
 (\*\*) Losses Include Also the Tail

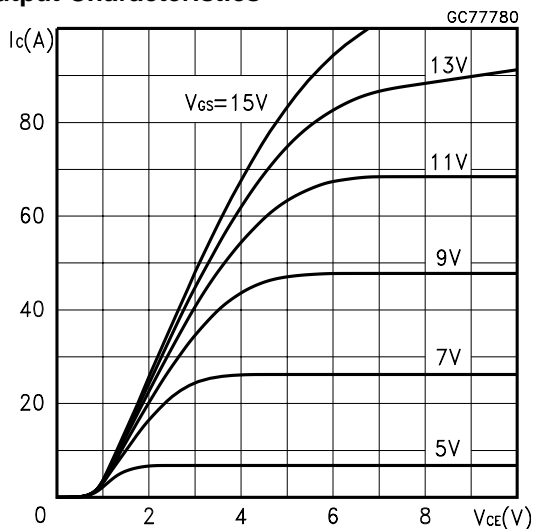
Switching Off Safe Operating Area



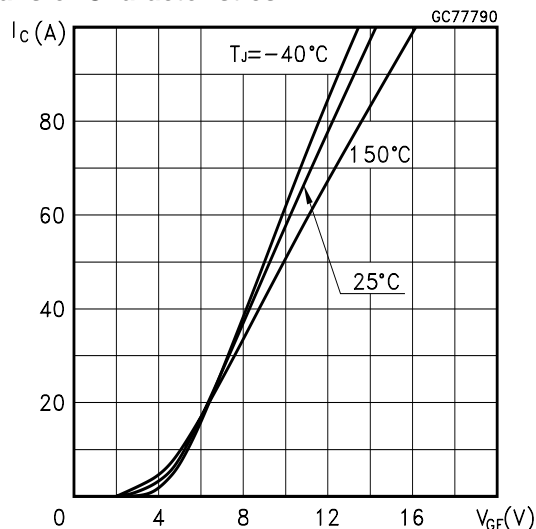
Thermal Impedance



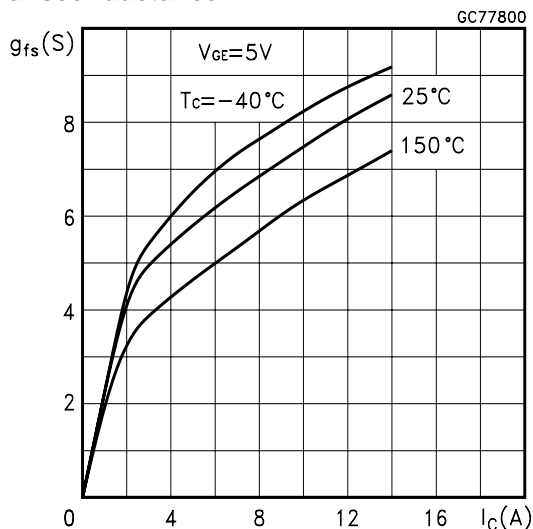
Output Characteristics



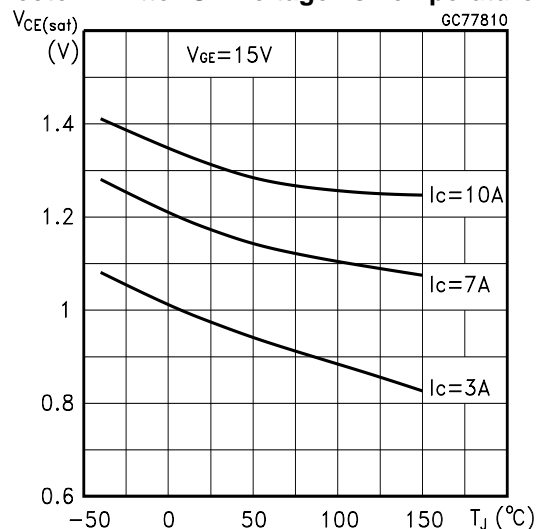
Transfer Characteristics



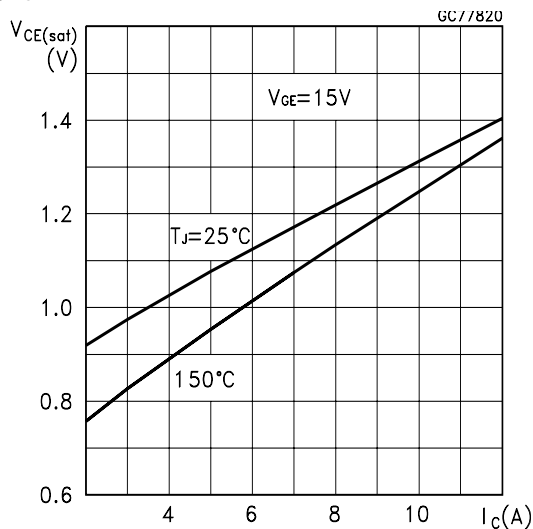
Transconductance



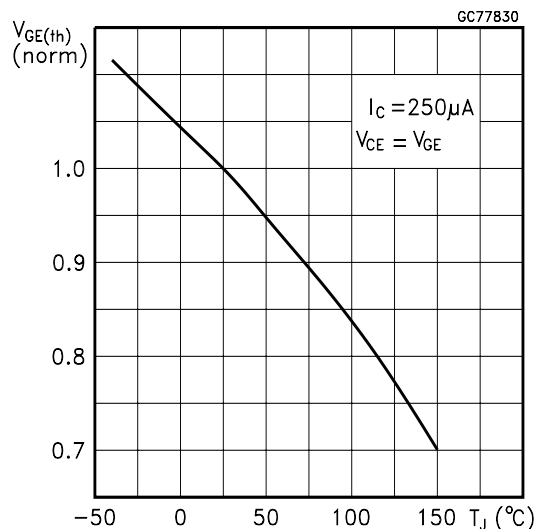
Collector-Emitter On Voltage vs Temperature



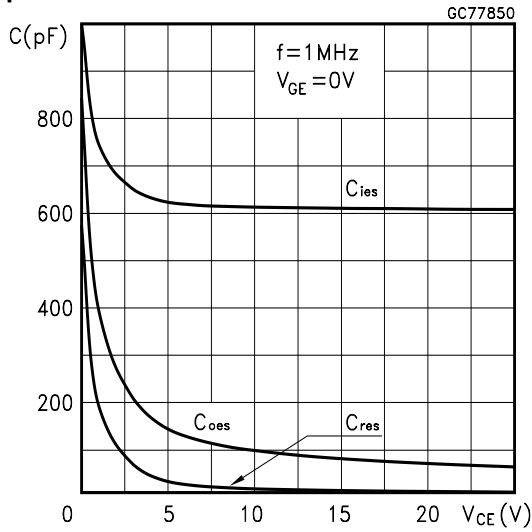
Collector-Emitter On Voltage vs Collector Current



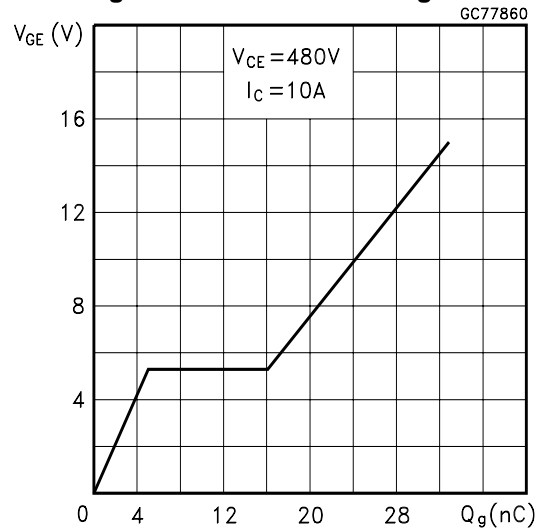
Gate Threshold Voltage vs Temperature



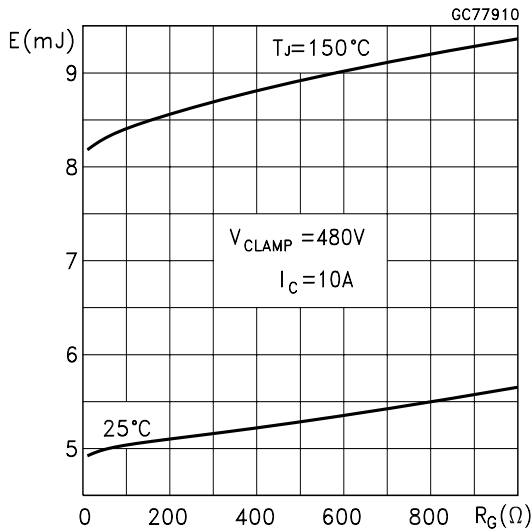
Capacitance Variations



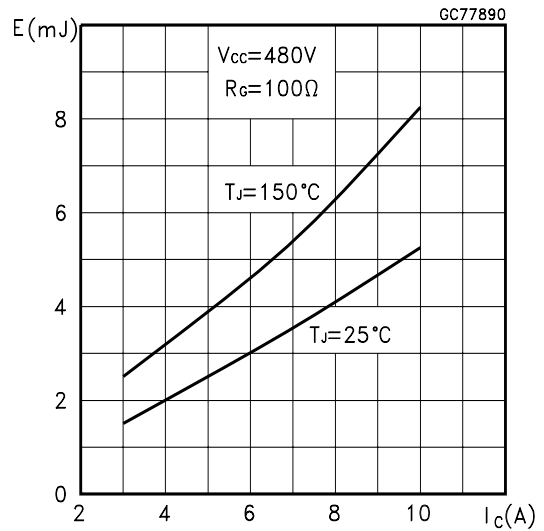
Gate Charge vs Gate-Emitter Voltage



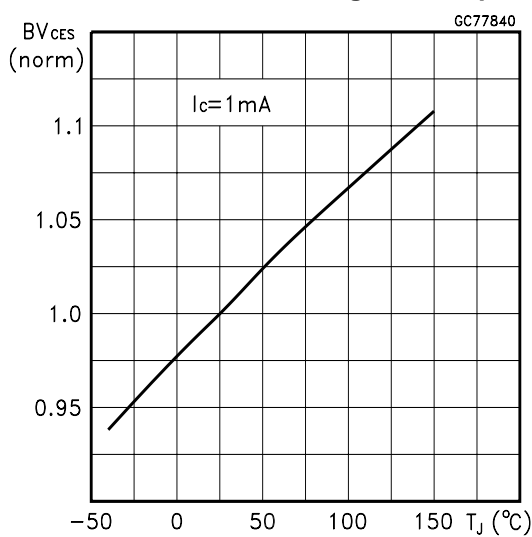
Off Losses vs Gate Resistance



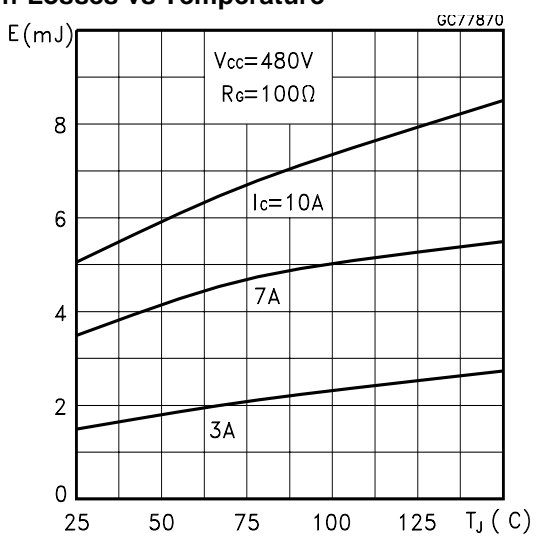
Off Losses vs Collector Current



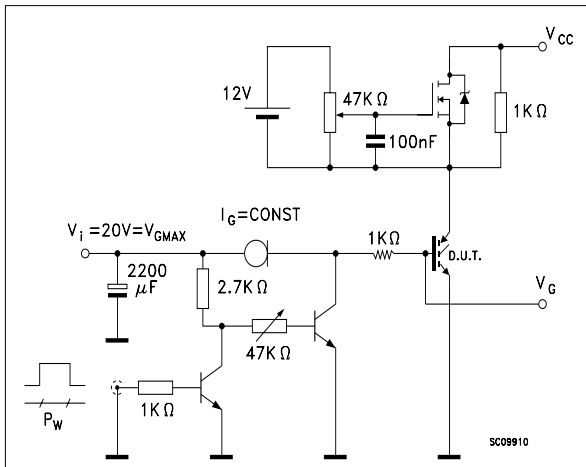
Normalized Break-down Voltage vs Temp.



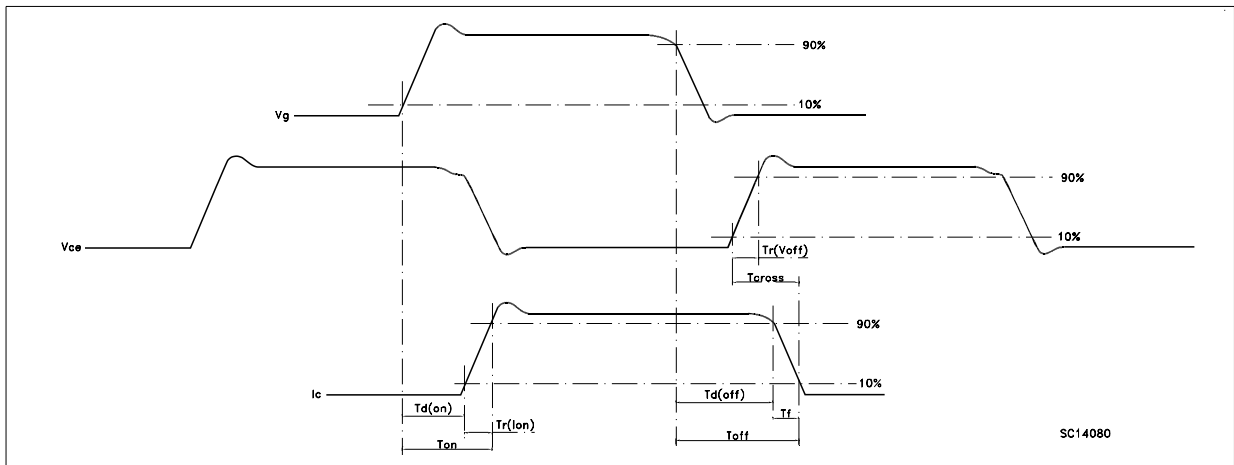
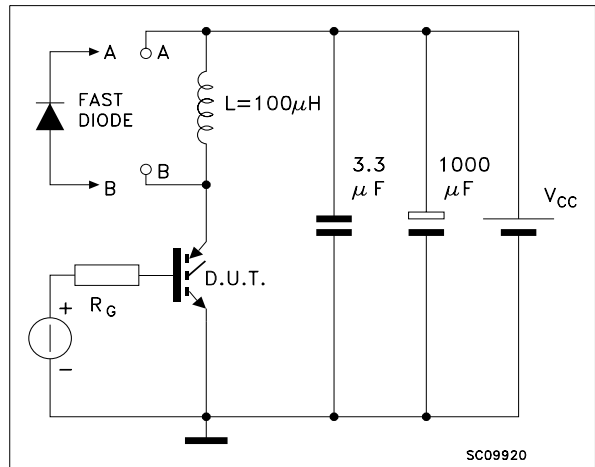
Off Losses vs Temperature



**Fig. 1: Gate Charge test Circuit**

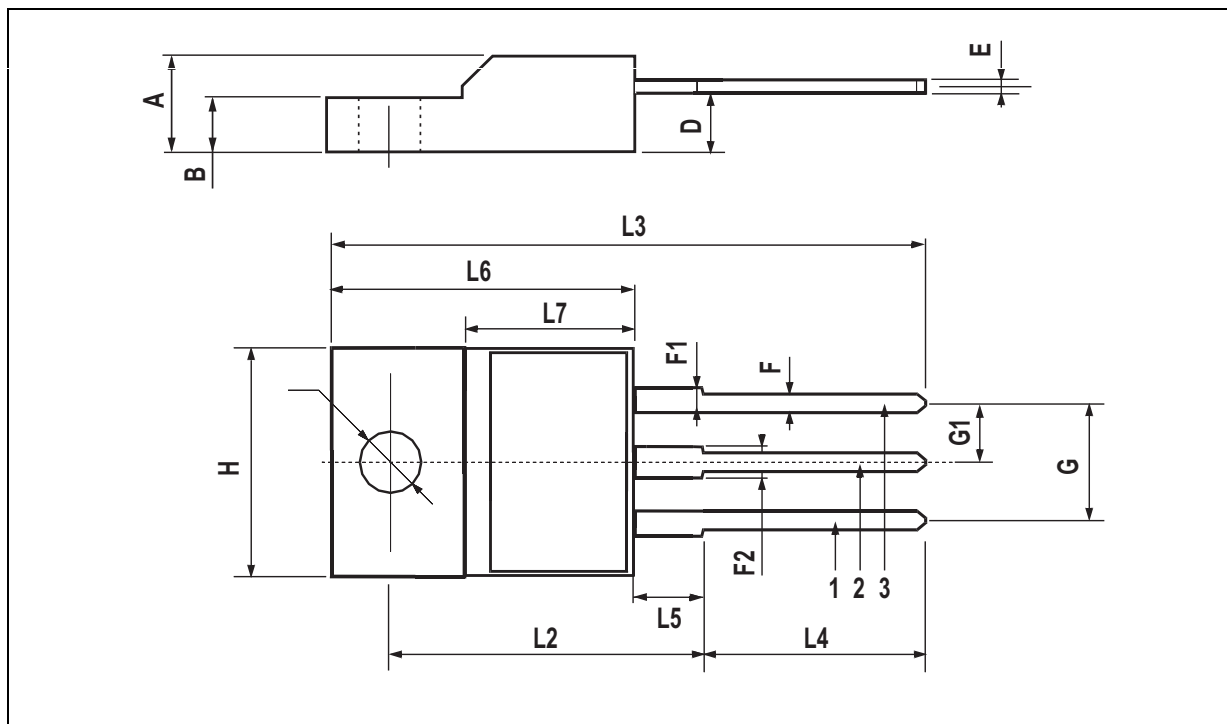


**Fig. 2: Test Circuit For Inductive Load Switching**



## TO-220FP MECHANICAL DATA

DIM.	mm.			inch		
	MIN.	TYP	MAX.	MIN.	TYP.	MAX.
A	4.4		4.6	0.173		0.181
B	2.5		2.7	0.098		0.106
D	2.5		2.75	0.098		0.108
E	0.45		0.7	0.017		0.027
F	0.75		1	0.030		0.039
F1	1.15		1.5	0.045		0.067
F2	1.15		1.5	0.045		0.067
G	4.95		5.2	0.195		0.204
G1	2.4		2.7	0.094		0.106
H	10		10.4	0.393		0.409
L2		16			0.630	
L3	28.6		30.6	1.126		1.204
L4	9.8		10.6	.0385		0.417
L5	2.9		3.6	0.114		0.141
L6	15.9		16.4	0.626		0.645
L7	9		9.3	0.354		0.366
Ø	3		3.2	0.118		0.126



Information furnished is believed to be accurate and reliable. However, STMicroelectronics assumes no responsibility for the consequences of use of such information nor for any infringement of patents or other rights of third parties which may result from its use. No license is granted by implication or otherwise under any patent or patent rights of STMicroelectronics. Specifications mentioned in this publication are subject to change without notice. This publication supersedes and replaces all information previously supplied. STMicroelectronics products are not authorized for use as critical components in life support devices or systems without express written approval of STMicroelectronics.

© The ST logo is a registered trademark of STMicroelectronics

© 2002 STMicroelectronics - Printed in Italy - All Rights Reserved  
STMicroelectronics GROUP OF COMPANIES

Australia - Brazil - Canada - China - Finland - France - Germany - Hong Kong - India - Israel - Italy - Japan - Malaysia - Malta - Morocco  
Singapore - Spain - Sweden - Switzerland - United Kingdom - United States.

© <http://www.st.com>