

Bias Resistor Transistor

PNP Silicon Surface Mount Transistor with Monolithic Bias Resistor Network

This new series of digital transistors is designed to replace a single device and its external resistor bias network. The BRT (Bias Resistor Transistor) contains a single transistor with a monolithic bias network consisting of two resistors; a series base resistor and a base-emitter resistor. The BRT eliminates these individual components by integrating them into a single device. The use of a BRT can reduce both system cost and board space. The device is housed in the SOT-23 package which is designed for low power surface mount applications.

- * Simplifies Circuit Design
- * Reduces Board Space
- * Reduces Component Count
- * The SOT-23 package can be soldered using wave or reflow. The modified gull-winged leads absorb thermal stress during soldering eliminating the possibility of damage to the die.
- * Available in 8 mm embossed tape and reel. Use the Device Number to order the 7 inch/3000 unit reel. Replace "T1" with "T3" in the Device Number to order the 13 inch/10,000 unit reel.

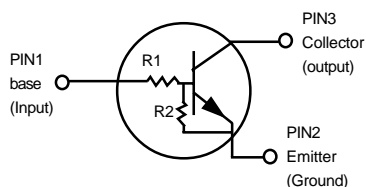

MMUN2211RLT1
MMUN2212RLT1
MMUN2213RLT1
MMUN2214RLT1
MMUN2215RLT1
MMUN2230RLT1
MMUN2231RLT1
MMUN2232RLT1
MMUN2233RL34

**NPN SILICON
BIAS RESISTOR
TRANSISTOR**

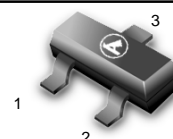

**CASE 318-08, STYLE 6
SOT- 23 (TO-236AB)**

MAXIMUM RATINGS ($T_A = 25^\circ\text{C}$ unless otherwise noted)

Rating	Symbol	Value	Unit
Collector-Base Voltage	V_{CBO}	50	Vdc
Collector-Emitter Voltage	V_{CEO}	50	Vdc
Collector Current	I_C	100	mAdc
Total Power Dissipation @ $T_A = 25^\circ\text{C}$ ⁽¹⁾	P_D	200	mW
Derate above 25°C		1.6	mW/ $^\circ\text{C}$

THERMAL CHARACTERISTICS

Rating	Symbol	Value	Unit
Thermal Resistance — Junction-to-Ambient (surface mounted)	$R_{\theta JA}$	625	$^\circ\text{C}/\text{W}$
Operating and Storage Temperature Range	T_J, T_{stg}	-65 to +150	$^\circ\text{C}$
Maximum Temperature for Soldering Purposes Time in Solder Bath	T_L	260 10	$^\circ\text{C}$ Sec

DEVICE MARKING AND RESISTOR VALUES

Device	Marking	R1 (K)	R2 (K)
MMUN2211RLT1	A8A	10	10
MMUN2212RLT1	A8B	22	22
MMUN2213RLT1	A8C	47	47
MMUN2214RLT1	A8D	10	47
MMUN2215RLT1 ⁽²⁾	A8E	10	∞
MMUN2216RLT1 ⁽²⁾	A8F	4.7	∞
MMUN2230RLT1 ⁽²⁾	A8G	1	1
MMUN2231RLT1 ⁽²⁾	A8H	2.2	2.2
MMUN2232RLT1 ⁽²⁾	A8J	4.7	4.7
MMUN2233RLT1 ⁽²⁾	A8K	4.7	47
MMUN2234RLT1 ⁽²⁾	A8L	22	47

1. Device mounted on a FR-4 glass epoxy printed circuit board using the minimum recommended footprint.

2. New devices. Updated curves to follow in subsequent data sheets.

MMUN2211RLT1 SERIES
ELECTRICAL CHARACTERISTICS ($T_A = 25^\circ\text{C}$ unless otherwise noted)

Characteristic	Symbol	Min	Typ	Max	Unit
OFF CHARACTERISTICS					
Collector-Base Cutoff Current ($V_{CB}=50\text{V}, I_E = 0$)	I_{CBO}	-	-	100	nAdc
Collector-Emitter Cutoff Current ($V_{CE} = 50\text{V}, I_B = 0$)	I_{CEO}	-	-	500	nAdc
Emitter-Base Cutoff Current ($V_{EB} = 6.0\text{V}, I_C = 0$)	MMUN2211RLT1	-	-	0.5	mAdc
	MMUN2212RLT1	-	-	0.2	
	MMUN2213RLT1	-	-	0.1	
	MMUN2214RLT1	-	-	0.2	
	MMUN2215RLT1	-	-	0.9	
	MMUN2216RLT1	-	-	1.9	
	MMUN2230RLT1	-	-	4.3	
	MMUN2231RLT1	-	-	2.3	
	MMUN2232RLT1	-	-	1.5	
	MMUN2233RLT1	-	-	0.18	
MMUN2234RLT1	-	-	0.13		
Collector-Base Breakdown Voltage ($I_C=10\text{mA}, I_E=0$)	$V_{(BR)CBO}$	50	-	-	Vdc
Collector-Emitter Breakdown Voltage ⁽³⁾ ($I_C=2.0\text{mA}, I_B=0$)	$V_{(BR)CEO}$	50	-	-	Vdc
ON CHARACTERISTICS ⁽³⁾					
DC Current Gain ($V_{CE} = 10\text{V}, I_C = 5.0\text{mA}$)	MMUN2211RLT1	h_{FE}	35	60	-
	MMUN2212RLT1		60	100	-
	MMUN2213RLT1		80	140	-
	MMUN2214RLT1		80	140	-
	MMUN2215RLT1		160	350	-
	MMUN2216RLT1		160	350	-
	MMUN2230RLT1		3.0	5.0	-
	MMUN2231RLT1		8.0	15	-
	MMUN2232RLT1		15	30	-
	MMUN2233RLT1		80	200	-
	MMUN2234RLT1		80	150	-
Collector-Emitter Saturation Voltage ($I_C=10\text{mA}, I_E=0.3\text{mA}$) ($I_C = 10\text{mA}, I_B = 5\text{mA}$) MMUN2230RLT1 MMUN2231RLT1 ($I_C = 10\text{mA}, I_B = 1\text{mA}$) MMUN2215RLT1 MMUN2216RLT1 MMUN2232RLT1 MMUN2233RLT1 MMUN2234RLT1	$V_{CE(sat)}$	-	-	0.25	Vdc
Output Voltage (on) ($V_{CC}=5.0\text{V}, V_B=2.5\text{V}, R_L=1.0\text{k}\Omega$)	MMUN2211RLT1	V_{OL}	-	-	0.2
	MMUN2212RLT1		-	-	0.2
	MMUN2214RLT1		-	-	0.2
	MMUN2215RLT1		-	-	0.2
	MMUN2216RLT1		-	-	0.2
	MMUN2230RLT1		-	-	0.2
	MMUN2231RLT1		-	-	0.2
	MMUN2232RLT1		-	-	0.2
	MMUN2233RLT1		-	-	0.2
	MMUN2234RLT1		-	-	0.2
($V_{CC} = 5.0\text{V}, V_B=3.5\text{V}, R_L= 1.0\text{k}\Omega$) MMUN2213RLT1		-	-	0.2	
Output Voltage(off)($V_{CC}=5.0\text{V}, V_B=0.5\text{V}, R_L=1.0\text{k}\Omega$) ($V_{CC}=5.0\text{V}, V_B=0.05\text{V}, R_L=1.0\text{k}\Omega$) ($V_{CC}=5.0\text{V}, V_B=0.25\text{V}, R_L=1.0\text{k}\Omega$)	MMUN2230RLT1	V_{OH}	4.9	-	-
	MMUN2215RLT1				
	MMUN2216RLT1				
	MMUN2233RLT1				

 3. Pulse Test: Pulse Width < 300 μs , Duty Cycle < 2.0%

MMUN2211RLT1 SERIES

ELECTRICAL CHARACTERISTICS ($T_A = 25^\circ\text{C}$ unless otherwise noted) (Continued)

Characteristic	Symbol	Min	Typ	Max	Unit	
ON CHARACTERISTICS ⁽³⁾						
Input Resistor	MMUN2211RLT1	R1	7.0	10	13	k Ω
	MMUN2212RLT1		15.4	22	28.6	
	MMUN2213RLT1		32.9	47	61.1	
	MMUN2214RLT1		7.0	10	13	
	MMUN2215RLT1		7.0	10	13	
	MMUN2216RLT1		3.3	4.7	6.1	
	MMUN2230RLT1		0.7	1.0	1.3	
	MMUN2231RLT1		1.5	2.2	2.9	
	MMUN2232RLT1		3.3	4.7	6.1	
	MMUN2233RLT1		3.3	4.7	6.1	
MMUN2234RLT1		15.4	22	28.6		
Resistor Ratio	MMUN2211RLT1 MMUN2212RLT1 MMUN2213RLT1	R1/R2	0.8	1.0	1.2	
	MMUN2214RLT1		0.17	0.21	0.25	
	MMUN2215RLT1 MMUN2216RLT1		—	—	—	
	MMUN2230RLT1 MMUN2231RLT1 MMUN2232RLT1		0.8	1.0	1.2	
	MMUN2233RLT1		0.055	0.1	0.185	
	MMUN2234RLT1		0.38	0.47	0.56	

3. Pulse Test: Pulse Width < 300 μs , Duty Cycle < 2.0%.

MMUN2211RLT1 SERIES

TYPICAL ELECTRICAL CHARACTERISTICS
MMUN2211RLT1

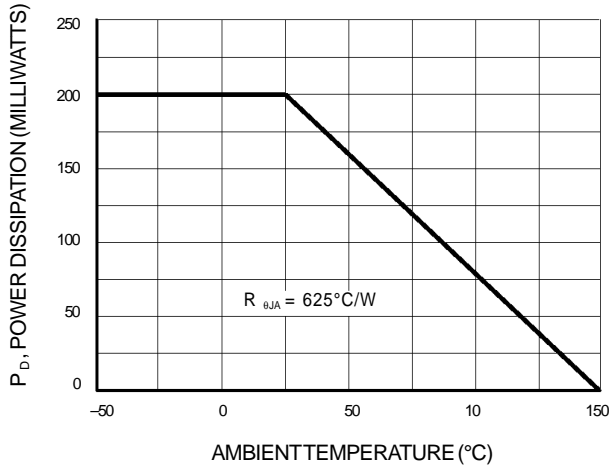

Figure 1. Derating Curve

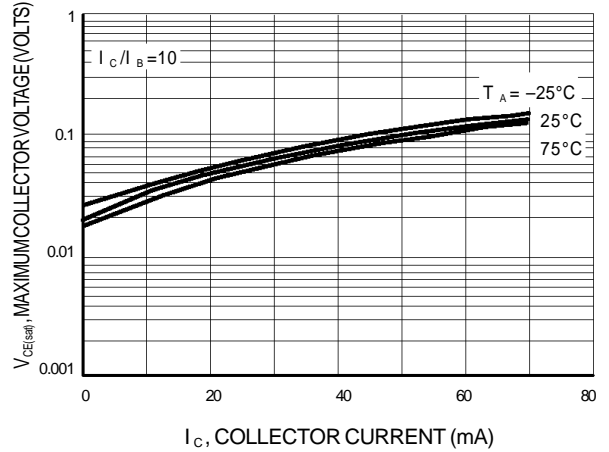

Figure 2. $V_{CE(sat)}$ versus I_C

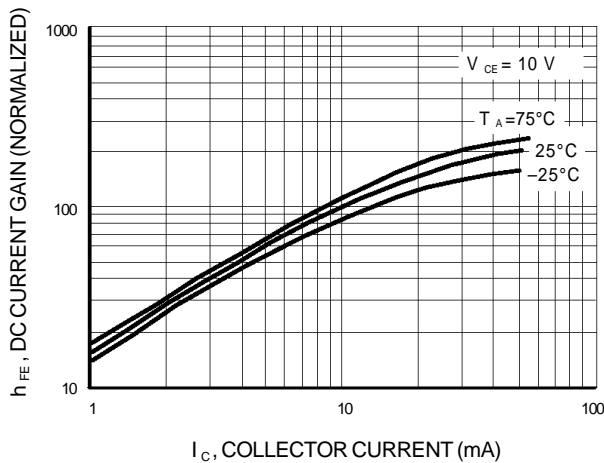

Figure 3. DC Current Gain

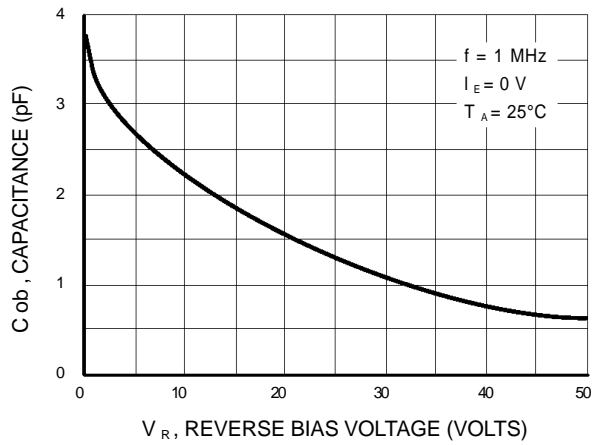

Figure 4. Output Capacitance

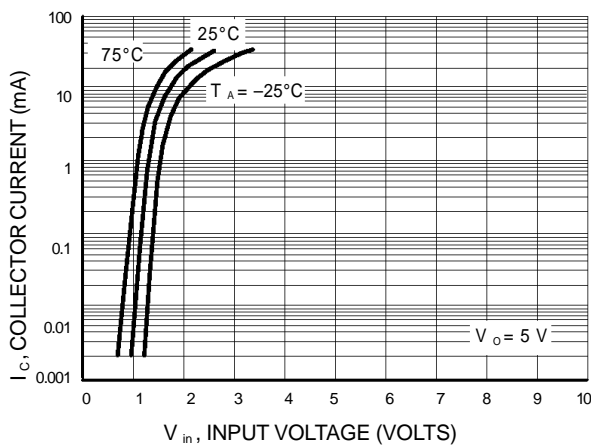

Figure 5. $V_{CE(sat)}$ versus I_C

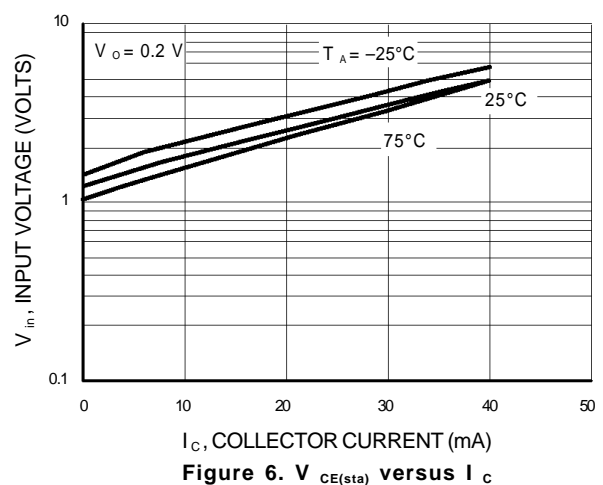

Figure 6. $V_{CE(sat)}$ versus I_C

MMUN2211RLT1 SERIES

TYPICAL ELECTRICAL CHARACTERISTICS
MMUN2212RLT1

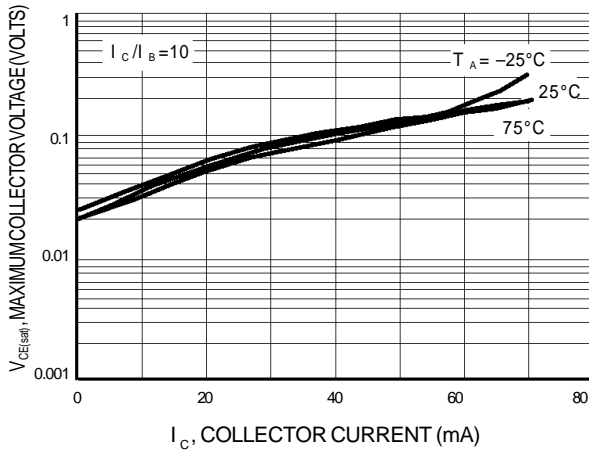

Figure 7. $V_{CE(sat)}$ versus I_C

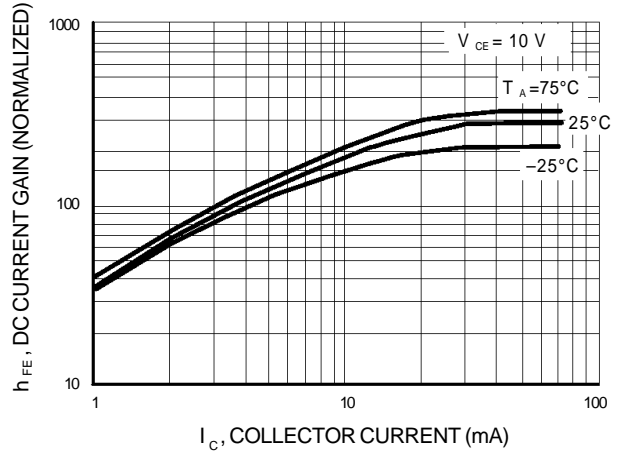

Figure 8. DC Current Gain

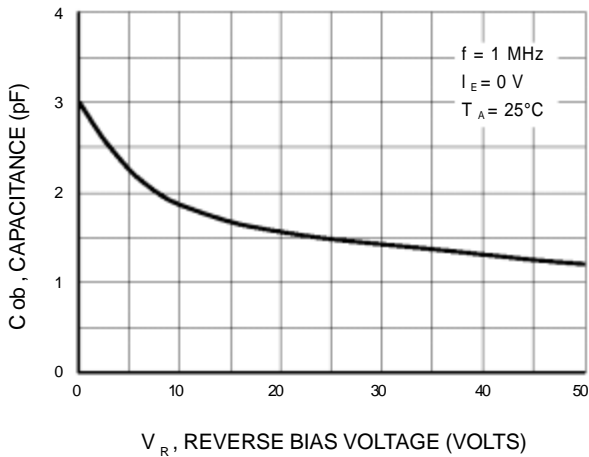

Figure 9. Output Capacitance

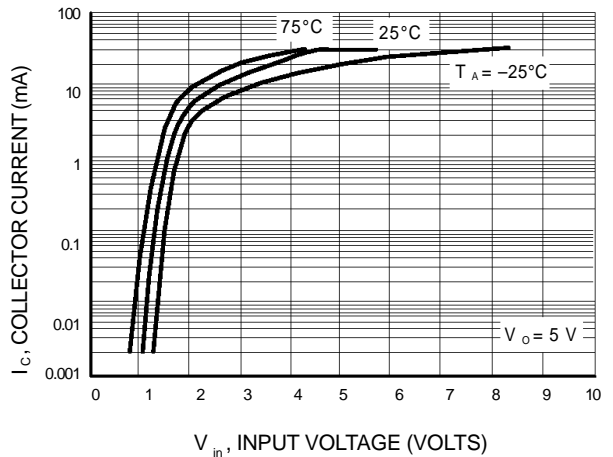

Figure 10. Output Current versus Input Voltage

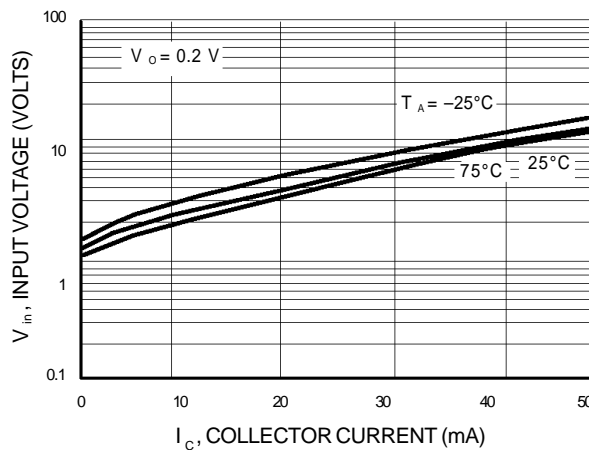

Figure 11. Input Voltage versus Output Current

MMUN2211RLT1 SERIES

TYPICAL ELECTRICAL CHARACTERISTICS

MMUN2213RLT1

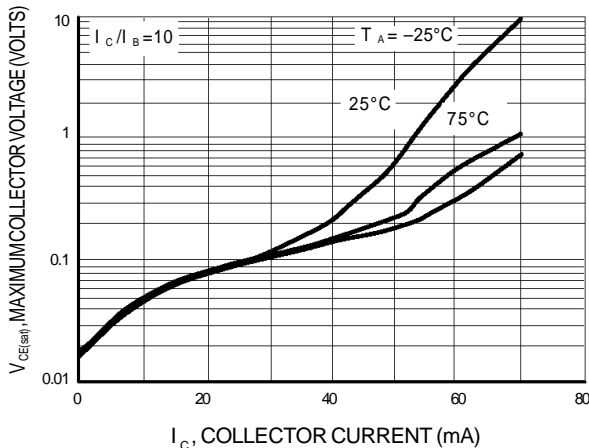

Figure 12. $V_{CE(sat)}$ versus I_C

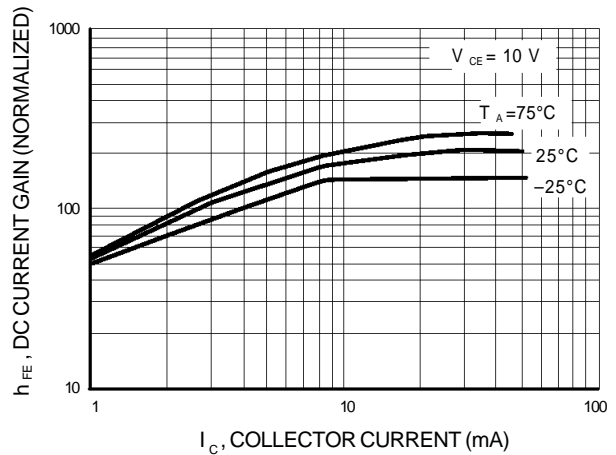

Figure 13. DC Current Gain

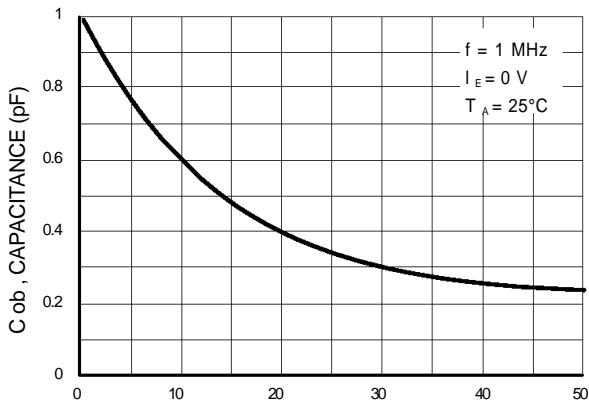

Figure 14. Output Capacitance

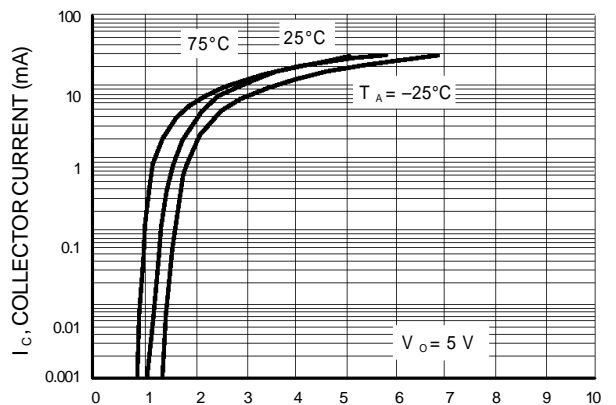

Figure 15. Output Current versus Input Voltage

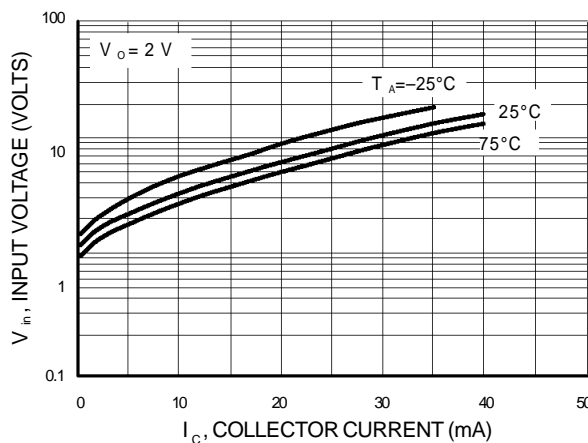

Figure 16. Input Voltage versus Output Current

MMUN2211RLT1 SERIES

TYPICAL ELECTRICAL CHARACTERISTICS
MMUN2214RLT1

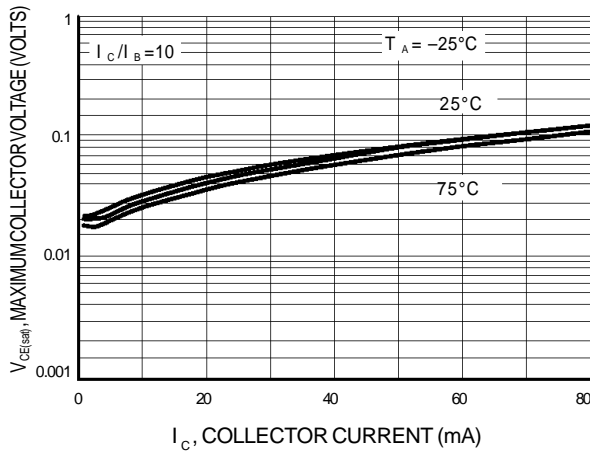

Figure 17. $V_{CE(sat)}$ versus I_C

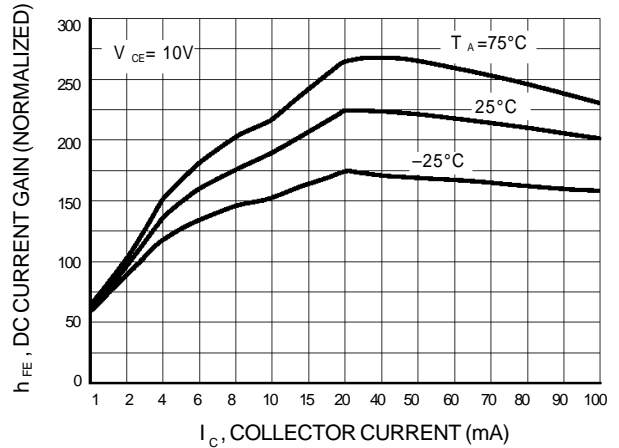

Figure 18. DC Current Gain

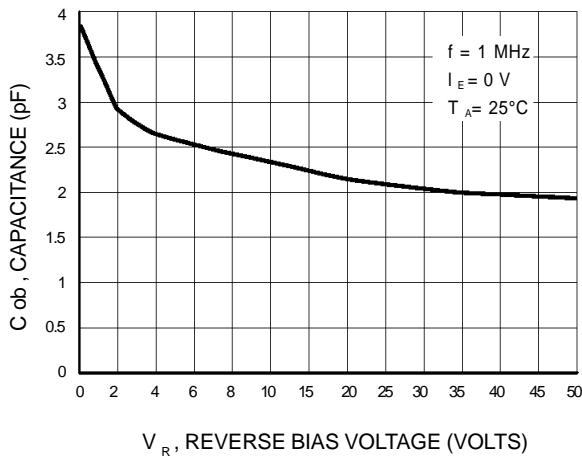

Figure 19. Output Capacitance

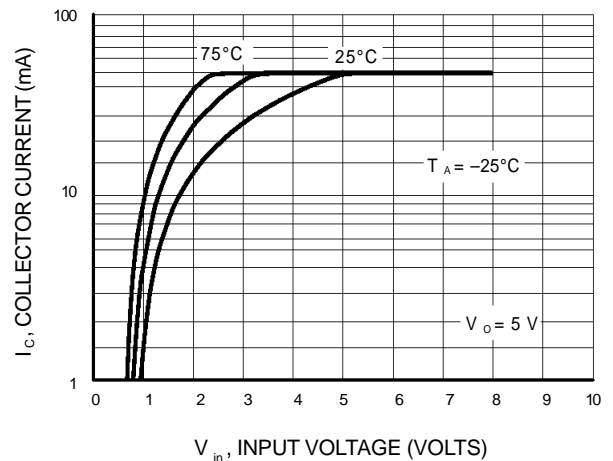

Figure 20. Output Current versus Input Voltage

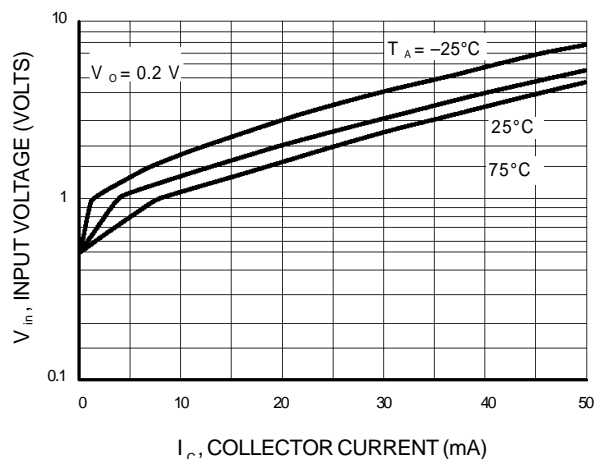

Figure 21. Input Voltage versus Output Current

MMUN2211RLT1 SERIES

TYPICAL APPLICATIONS FOR NPN BRTs

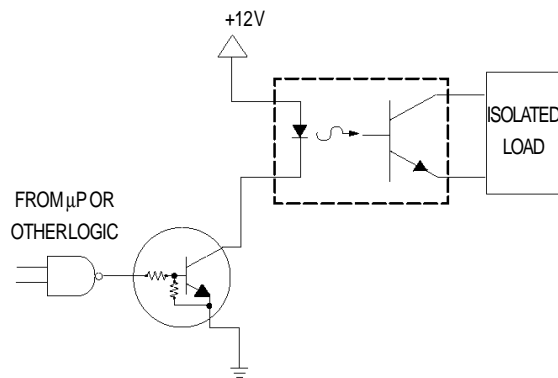

Figure 22. Level Shifter: Connects 12 or 24 Volt Circuits to Logic

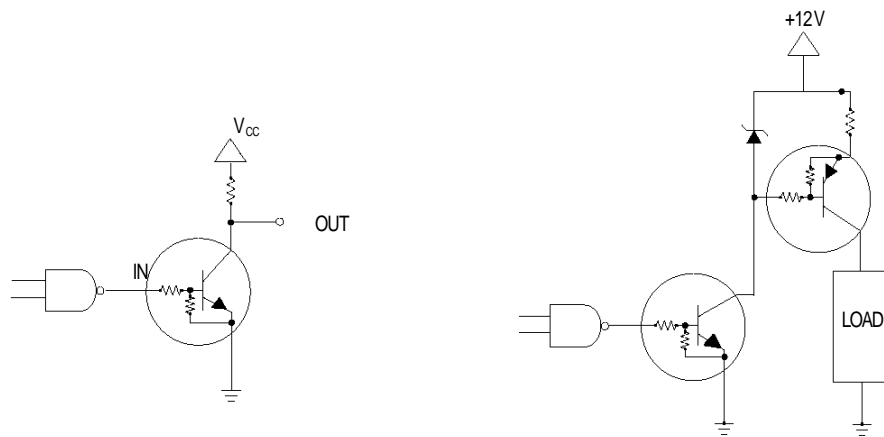

Figure 23. Open Collector Inverter: Inverts the Input Signal

Figure 24. Inexpensive, Unregulated Current Source