

TOSHIBA VARIABLE CAPACITANCE DIODE SILICON EPITAXIAL PLANAR TYPE

1SV217

CATV TUNING.

- High Capacitance Ratio : $C_{2V} / C_{25V} = 12.5$ (Typ.)
- Excellent C-V Characteristics, and Small Tracking Error.
- Useful for Small Size Tuner.

MAXIMUM RATINGS (Ta = 25°C)

CHARACTERISTIC	SYMBOL	RATING	UNIT
Reverse Voltage	V_R	30	V
Peak Reverse Voltage	V_{RM}	35 ($R_L = 10k\Omega$)	V
Junction Temperature	T_j	125	°C
Storage Temperature Range	T_{stg}	-55~125	°C

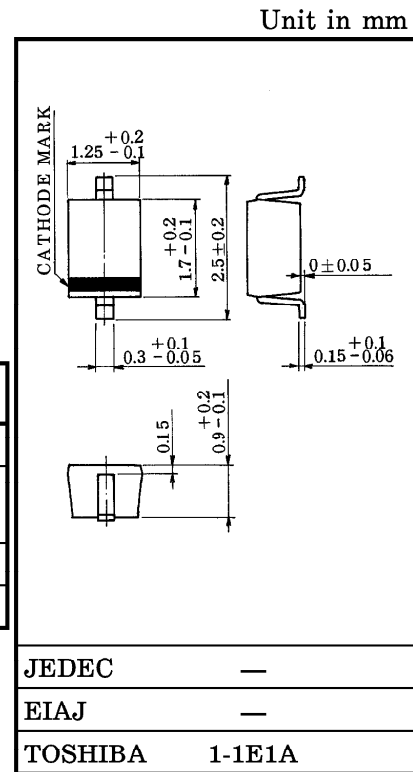

Weight : 0.004g

ELECTRICAL CHARACTERISTICS (Ta = 25°C)

CHARACTERISTIC	SYMBOL	TEST CONDITION	MIN.	TYP.	MAX.	UNIT
Reverse Voltage	V_R	$I_R = 1\mu A$	30	—	—	V
Reverse Current	I_R	$V_R = 28V$	—	—	10	nA
Capacitance	C_{2V}	$V_R = 2V, f = 1MHz$	33	36	39	pF
Capacitance	C_{25V}	$V_R = 25V, f = 1MHz$	2.6	2.88	3.2	pF
Capacitance Ratio	C_{2V} / C_{25V}	—	11.5	12.5	—	—
Series Resistance	r_s	$V_R = 5V, f = 470MHz$	—	0.83	1.0	Ω

Note 1 : Available in matched group for capacitance to 2.5%.

$$\frac{C(\text{Max.}) - C(\text{Min.})}{C(\text{Min.})} \leq 0.025$$

$(V_R = 2 \sim 25V)$

Marking

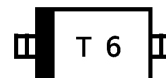

961001EAA2

● TOSHIBA is continually working to improve the quality and the reliability of its products. Nevertheless, semiconductor devices in general can malfunction or fail due to their inherent electrical sensitivity and vulnerability to physical stress. It is the responsibility of the buyer, when utilizing TOSHIBA products, to observe standards of safety, and to avoid situations in which a malfunction or failure of a TOSHIBA product could cause loss of human life, bodily injury or damage to property. In developing your designs, please ensure that TOSHIBA products are used within specified operating ranges as set forth in the most recent products specifications. Also, please keep in mind the precautions and conditions set forth in the TOSHIBA Semiconductor Reliability Handbook.

● The information contained herein is presented only as a guide for the applications of our products. No responsibility is assumed by TOSHIBA CORPORATION for any infringements of intellectual property or other rights of the third parties which may result from its use. No license is granted by implication or otherwise under any intellectual property or other rights of TOSHIBA CORPORATION or others.

● The information contained herein is subject to change without notice.

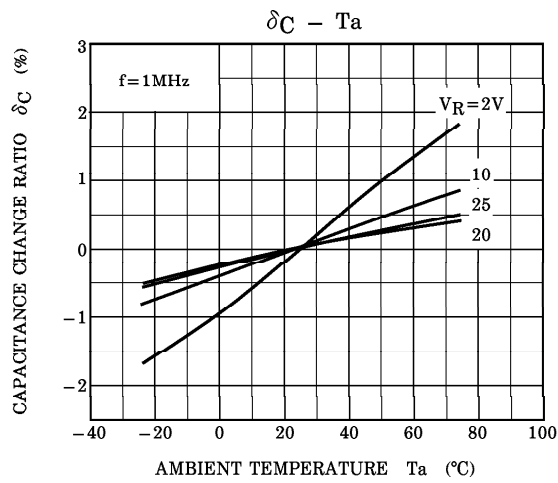
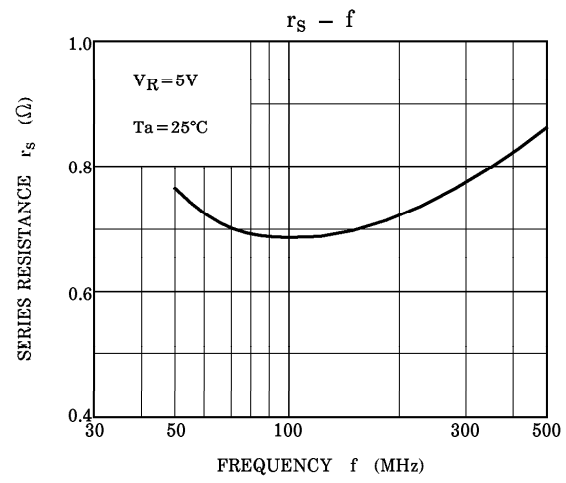
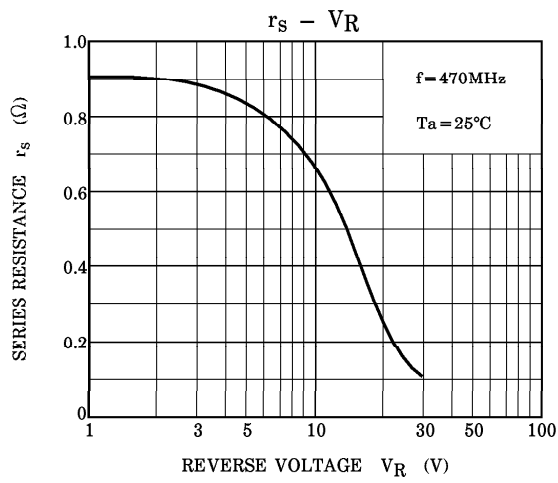
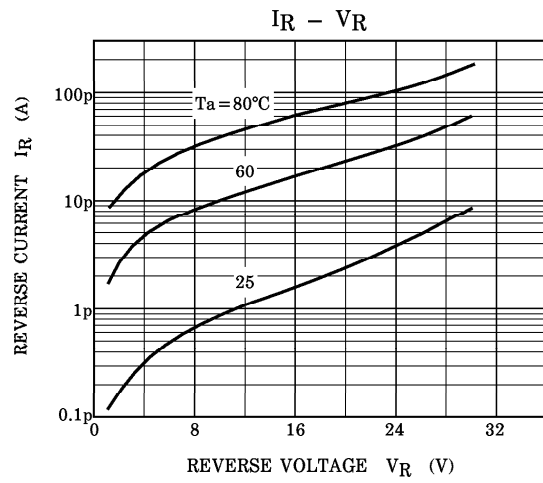
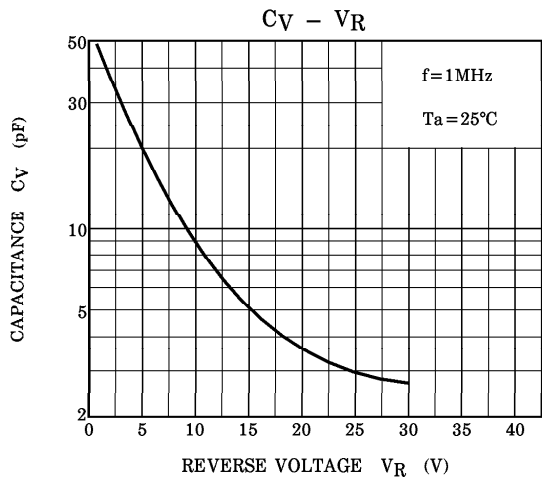

NOTE : $\delta C (\%) = \frac{C(T_a) - C(25)}{C(25)} \times 100$