



Low-Cost, Low-Power, Low-Dropout, SOT23-3 Voltage References

General Description

The MAX6001–MAX6005 family of SOT23, low-cost series voltage references meets the cost advantage of shunt references and offers the power-saving advantage of series references, which traditionally cost more. Unlike conventional shunt-mode (two-terminal) references that must be biased at the load current and require an external resistor, these devices eliminate the need for an external resistor and offer a supply current that is virtually independent of the supply voltage.

These micropower, low-dropout, low-cost devices are ideal for high-volume, cost-sensitive 3V and 5V battery-operated systems with wide variations in supply voltage that require very low power dissipation. Additionally, these devices are internally compensated and do not require an external compensation capacitor, saving valuable board area in space-critical applications.

Applications

Portable/Battery-Powered Equipment
 Notebook Computers
 PDAs, GPSs, and DMMs
 Cellular Phones
 Pagers
 Hard-Disk Drives

Selector Guide

| PART | OUTPUT VOLTAGE (V) | INPUT VOLTAGE (V) |
|---------|--------------------|------------------------------------|
| MAX6001 | 1.250 | 2.5 to 12.6 |
| MAX6002 | 2.500 | (V _{OUT} + 200mV) to 12.6 |
| MAX6003 | 3.000 | (V _{OUT} + 200mV) to 12.6 |
| MAX6004 | 4.096 | (V _{OUT} + 200mV) to 12.6 |
| MAX6005 | 5.000 | (V _{OUT} + 200mV) to 12.6 |

Pin Configuration

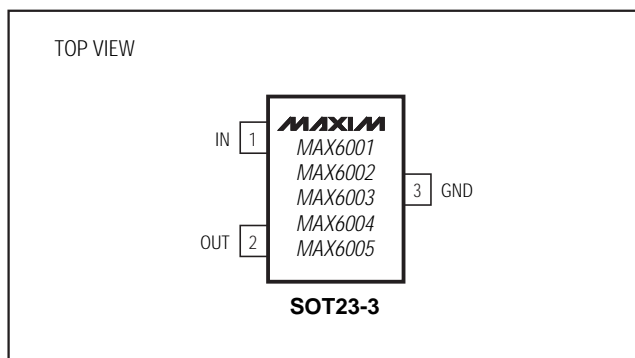

Features

- ◆ 1% max Initial Accuracy
- ◆ 100ppm/°C max Temperature Coefficient
- ◆ 45µA max Quiescent Supply Current
- ◆ 0.8µA/V Supply Current Variation with V_{IN}
- ◆ ±400µA Output Source and Sink Current
- ◆ 100mV Dropout at 400µA Load Current
- ◆ 0.12µV/µA Load Regulation
- ◆ 8µV/V Line Regulation
- ◆ Stable with C_{LOAD} = 0 to 2.2nF

Ordering Information

| PART | TEMP. RANGE | PIN-PACKAGE | SOT TOP MARK |
|--------------|----------------|-------------|--------------|
| MAX6001EUR-T | -40°C to +85°C | 3 SOT23-3 | FZCW |
| MAX6002EUR-T | -40°C to +85°C | 3 SOT23-3 | FZCX |
| MAX6003EUR-T | -40°C to +85°C | 3 SOT23-3 | FZDK |
| MAX6004EUR-T | -40°C to +85°C | 3 SOT23-3 | FZCY |
| MAX6005EUR-T | -40°C to +85°C | 3 SOT23-3 | FZCZ |

Typical Operating Circuit

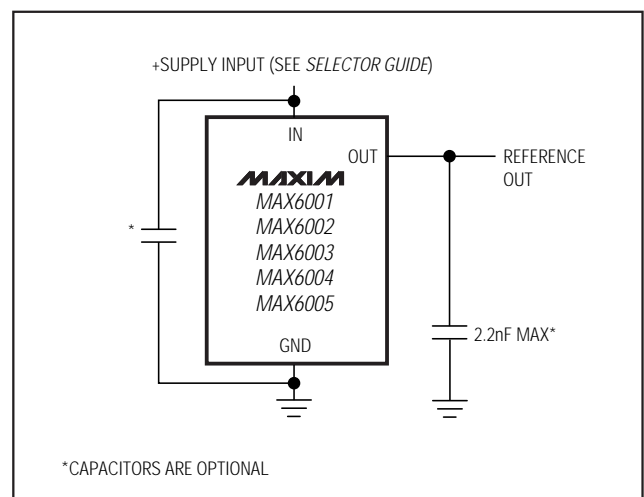

Low-Cost, Low-Power, Low-Dropout, SOT23-3 Voltage References

ABSOLUTE MAXIMUM RATINGS

Voltages Referenced to GND

| | |
|--|------------------------------|
| IN | -0.3V to +13.5V |
| OUT | -0.3V to ($V_{IN} + 0.3V$) |
| Output Short Circuit to GND or IN ($V_{IN} < 6V$) | Continuous |
| Output Short Circuit to GND or IN ($V_{IN} \geq 6V$) | 60sec |

Continuous Power Dissipation ($T_A = +70^\circ\text{C}$)

| | |
|---|---|
| SOT23-3 (derate 4.0mW/ $^\circ\text{C}$ above $+70^\circ\text{C}$) | 320mW |
| Operating Temperature Range | -40°C to $+85^\circ\text{C}$ |
| Storage Temperature Range | -65°C to $+150^\circ\text{C}$ |
| Lead Temperature (soldering, 10sec) | $+300^\circ\text{C}$ |

Stresses beyond those listed under "Absolute Maximum Ratings" may cause permanent damage to the device. These are stress ratings only, and functional operation of the device at these or any other conditions beyond those indicated in the operational sections of the specifications is not implied. Exposure to absolute maximum rating conditions for extended periods may affect device reliability.

ELECTRICAL CHARACTERISTICS—MAX6001

($V_{IN} = +5V$, $I_{OUT} = 0$, $T_A = T_{MIN}$ to T_{MAX} , unless otherwise noted. Typical values are at $T_A = +25^\circ\text{C}$.) (Note 1)

| PARAMETER | SYMBOL | CONDITIONS | MIN | TYP | MAX | UNITS |
|---|---|--|-------|-------|-------|---------------------------|
| OUTPUT | | | | | | |
| Output Voltage | V_{OUT} | $T_A = +25^\circ\text{C}$ | 1.237 | 1.250 | 1.263 | V |
| Output Voltage Temperature Coefficient (Note 2) | TCV_{OUT} | | | 20 | 100 | ppm/ $^\circ\text{C}$ |
| Line Regulation | $\frac{\Delta V_{OUT}}{\Delta V_{IN}}$ | $2.5V \leq V_{IN} \leq 12.6V$ | | 8 | 120 | $\mu\text{V/V}$ |
| Load Regulation | $\frac{\Delta V_{OUT}}{\Delta I_{OUT}}$ | Sourcing: $0 \leq I_{OUT} \leq 400\mu\text{A}$ | | 0.12 | 0.8 | $\mu\text{V}/\mu\text{A}$ |
| | | Sinking: $-400\mu\text{A} \leq I_{OUT} \leq 0$ | | 0.15 | 1.0 | |
| OUT Short-Circuit Current | I_{SC} | Short to GND | | 4 | | mA |
| | | Short to IN | | 4 | | |
| Temperature Hysteresis (Note 3) | | | | 130 | | ppm |
| Long-Term Stability | $\frac{\Delta V_{OUT}}{\text{time}}$ | 1,000 hours at $T_A = +25^\circ\text{C}$ | | 50 | | ppm/ 1,000hrs |
| DYNAMIC | | | | | | |
| Noise Voltage | e_{OUT} | $f = 0.1\text{Hz}$ to 10Hz | | 25 | | $\mu\text{Vp-p}$ |
| | | $f = 10\text{Hz}$ to 10kHz | | 65 | | μV_{RMS} |
| Ripple Rejection | $\frac{\Delta V_{OUT}}{\Delta V_{IN}}$ | $V_{IN} = 5V \pm 100\text{mV}$, $f = 120\text{Hz}$ | | 86 | | dB |
| Turn-On Settling Time | t_R | To $V_{OUT} = 0.1\%$ of final value, $C_{OUT} = 50\text{pF}$ | | 30 | | μs |
| Capacitive-Load Stability Range | C_{OUT} | (Note 4) | 0 | | 2.2 | nF |
| INPUT | | | | | | |
| Supply Voltage Range | V_{IN} | Guaranteed by line-regulation test | 2.5 | | 12.6 | V |
| Quiescent Supply Current | I_{IN} | | | 27 | 45 | μA |
| Change in Supply Current | I_{IN}/V_{IN} | $2.5V \leq V_{IN} \leq 12.6V$ | | 0.8 | 2.6 | $\mu\text{A/V}$ |

Low-Cost, Low-Power, Low-Dropout, SOT23-3 Voltage References

MAX6001-MAX6005

ELECTRICAL CHARACTERISTICS—MAX6002

($V_{IN} = +5V$, $I_{OUT} = 0$, $T_A = T_{MIN}$ to T_{MAX} , unless otherwise noted. Typical values are at $T_A = +25^\circ C$.) (Note 1)

| PARAMETER | SYMBOL | CONDITIONS | MIN | TYP | MAX | UNITS |
|---|---|--|-----------------|-------|-------|------------------|
| OUTPUT | | | | | | |
| Output Voltage | V_{OUT} | $T_A = +25^\circ C$ | 2.475 | 2.500 | 2.525 | V |
| Output Voltage Temperature Coefficient (Note 2) | TCV_{OUT} | | | 20 | 100 | ppm/ $^\circ C$ |
| Line Regulation | $\frac{\Delta V_{OUT}}{\Delta V_{IN}}$ | $(V_{OUT} + 0.2V) \leq V_{IN} \leq 12.6V$ | | 15 | 200 | $\mu V/V$ |
| Load Regulation | $\frac{\Delta V_{OUT}}{\Delta I_{OUT}}$ | Sourcing: $0 \leq I_{OUT} \leq 400\mu A$ | | 0.14 | 0.90 | $\mu V/\mu A$ |
| | | Sinking: $-400\mu A \leq I_{OUT} \leq 0$ | | 0.18 | 1.10 | |
| Dropout Voltage (Note 5) | $V_{IN} - V_{OUT}$ | $I_{OUT} = 400\mu A$ | | 100 | 200 | mV |
| OUT Short-Circuit Current | I_{SC} | Short to GND | | 4 | | mA |
| | | Short to IN | | 4 | | |
| Temperature Hysteresis (Note 3) | $\frac{\Delta V_{OUT}}{\text{time}}$ | | | 130 | | ppm |
| Long-Term Stability | $\frac{\Delta V_{OUT}}{\text{time}}$ | 1,000 hours at $T_A = +25^\circ C$ | | 50 | | ppm/ 1,000hrs |
| DYNAMIC | | | | | | |
| Noise Voltage | e_{OUT} | $f = 0.1\text{Hz to }10\text{Hz}$ | | 60 | | μV_{p-p} |
| | | $f = 10\text{Hz to }10\text{kHz}$ | | 125 | | μV_{RMS} |
| Ripple Rejection | $\frac{\Delta V_{OUT}}{\Delta V_{IN}}$ | $V_{IN} = 5V \pm 100\text{mV}$, $f = 120\text{Hz}$ | | 82 | | dB |
| Turn-On Settling Time | t_R | To $V_{OUT} = 0.1\%$ of final value, $C_{OUT} = 50\text{pF}$ | | 85 | | μs |
| Capacitive-Load Stability Range | C_{OUT} | (Note 4) | 0 | | 2.2 | nF |
| INPUT | | | | | | |
| Supply Voltage Range | V_{IN} | Guaranteed by line-regulation test | $V_{OUT} + 0.2$ | | 12.6 | V |
| Quiescent Supply Current | I_{IN} | | | 27 | 45 | μA |
| Change in Supply Current | I_{IN}/V_{IN} | $(V_{OUT} + 0.2V) \leq V_{IN} \leq 12.6V$ | | 0.8 | 2.6 | $\mu A/V$ |

Low-Cost, Low-Power, Low-Dropout, SOT23-3 Voltage References

MAX6001-MAX6005

ELECTRICAL CHARACTERISTICS—MAX6003

($V_{IN} = +5V$, $I_{OUT} = 0$, $T_A = T_{MIN}$ to T_{MAX} , unless otherwise noted. Typical values are at $T_A = +25^\circ C$.) (Note 1)

| PARAMETER | SYMBOL | CONDITIONS | MIN | TYP | MAX | UNITS |
|---|---|--|-----------------|------|------|------------------|
| OUTPUT | | | | | | |
| Output Voltage | V_{OUT} | $T_A = +25^\circ C$ | 2.97 | 3.00 | 3.03 | V |
| Output Voltage Temperature Coefficient (Note 2) | TCV_{OUT} | | | 20 | 100 | ppm/ $^\circ C$ |
| Line Regulation | $\frac{\Delta V_{OUT}}{\Delta V_{IN}}$ | $(V_{OUT} + 0.2V) \leq V_{IN} \leq 12.6V$ | | 20 | 220 | $\mu V/V$ |
| Load Regulation | $\frac{\Delta V_{OUT}}{\Delta I_{OUT}}$ | Sourcing: $0 \leq I_{OUT} \leq 400\mu A$ | | 0.14 | 0.90 | $\mu V/\mu A$ |
| | | Sinking: $-400\mu A \leq I_{OUT} \leq 0$ | | 0.18 | 1.10 | |
| Dropout Voltage (Note 5) | $V_{IN} - V_{OUT}$ | $I_{OUT} = 400\mu A$ | | 100 | 200 | mV |
| OUT Short-Circuit Current | I_{SC} | Short to GND | | 4 | | mA |
| | | Short to IN | | 4 | | |
| Temperature Hysteresis (Note 3) | $\frac{\Delta V_{OUT}}{\text{time}}$ | | | 130 | | ppm |
| Long-Term Stability | $\frac{\Delta V_{OUT}}{\text{time}}$ | 1,000 hours at $T_A = +25^\circ C$ | | 50 | | ppm/ 1,000hrs |
| DYNAMIC | | | | | | |
| Noise Voltage | e_{OUT} | $f = 0.1\text{Hz to }10\text{Hz}$ | | 75 | | μV_{p-p} |
| | | $f = 10\text{Hz to }10\text{kHz}$ | | 150 | | μV_{RMS} |
| Ripple Rejection | $\frac{\Delta V_{OUT}}{\Delta V_{IN}}$ | $V_{IN} = 5V \pm 100\text{mV}$, $f = 120\text{Hz}$ | | 80 | | dB |
| Turn-On Settling Time | t_R | To $V_{OUT} = 0.1\%$ of final value, $C_{OUT} = 50\text{pF}$ | | 100 | | μs |
| Capacitive-Load Stability Range | C_{OUT} | (Note 4) | 0 | | 2.2 | nF |
| INPUT | | | | | | |
| Supply Voltage Range | V_{IN} | Guaranteed by line-regulation test | $V_{OUT} + 0.2$ | | 12.6 | V |
| Quiescent Supply Current | I_{IN} | | | 27 | 45 | μA |
| Change in Supply Current | I_{IN}/V_{IN} | $(V_{OUT} + 0.2V) \leq V_{IN} \leq 12.6V$ | | 0.8 | 2.6 | $\mu A/V$ |

Low-Cost, Low-Power, Low-Dropout, SOT23-3 Voltage References

MAX6001-MAX6005

ELECTRICAL CHARACTERISTICS—MAX6004

($V_{IN} = +5V$, $I_{OUT} = 0$, $T_A = T_{MIN}$ to T_{MAX} , unless otherwise noted. Typical values are at $T_A = +25^\circ C$.) (Note 1)

| PARAMETER | SYMBOL | CONDITIONS | MIN | TYP | MAX | UNITS |
|---|---|--|-----------------|-------|-------|------------------|
| OUTPUT | | | | | | |
| Output Voltage | V_{OUT} | $T_A = +25^\circ C$ | 4.055 | 4.096 | 4.137 | V |
| Output Voltage Temperature Coefficient (Note 2) | TCV_{OUT} | | | 20 | 100 | ppm/ $^\circ C$ |
| Line Regulation | $\frac{\Delta V_{OUT}}{\Delta V_{IN}}$ | $(V_{OUT} + 0.2V) \leq V_{IN} \leq 12.6V$ | | 25 | 240 | $\mu V/V$ |
| Load Regulation | $\frac{\Delta V_{OUT}}{\Delta I_{OUT}}$ | Sourcing: $0 \leq I_{OUT} \leq 400\mu A$ | | 0.15 | 1.00 | $\mu V/\mu A$ |
| | | Sinking: $-400\mu A \leq I_{OUT} \leq 0$ | | 0.20 | 1.20 | |
| Dropout Voltage (Note 5) | $V_{IN} - V_{OUT}$ | $I_{OUT} = 400\mu A$ | | 100 | 200 | mV |
| OUT Short-Circuit Current | I_{SC} | Short to GND | | 4 | | mA |
| | | Short to IN | | 4 | | |
| Temperature Hysteresis (Note 3) | $\frac{\Delta V_{OUT}}{\text{time}}$ | 1,000 hours at $T_A = +25^\circ C$ | | 130 | | ppm |
| Long-Term Stability | $\frac{\Delta V_{OUT}}{\text{time}}$ | 1,000 hours at $T_A = +25^\circ C$ | | 50 | | ppm/ 1,000hrs |
| DYNAMIC | | | | | | |
| Noise Voltage | e_{OUT} | $f = 0.1\text{Hz to }10\text{Hz}$ | | 100 | | μV_{p-p} |
| | | $f = 10\text{Hz to }10\text{kHz}$ | | 200 | | μV_{RMS} |
| Ripple Rejection | $\frac{\Delta V_{OUT}}{\Delta V_{IN}}$ | $V_{IN} = 5V \pm 100\text{mV}$, $f = 120\text{Hz}$ | | 77 | | dB |
| Turn-On Settling Time | t_R | To $V_{OUT} = 0.1\%$ of final value, $C_{OUT} = 50\text{pF}$ | | 160 | | μs |
| Capacitive-Load Stability Range | C_{OUT} | (Note 4) | 0 | | 2.2 | nF |
| INPUT | | | | | | |
| Supply Voltage Range | V_{IN} | Guaranteed by line-regulation test | $V_{OUT} + 0.2$ | | 12.6 | V |
| Quiescent Supply Current | I_{IN} | | | 27 | 45 | μA |
| Change in Supply Current | I_{IN}/V_{IN} | $(V_{OUT} + 0.2V) \leq V_{IN} \leq 12.6V$ | | 0.8 | 2.6 | $\mu A/V$ |

Low-Cost, Low-Power, Low-Dropout, SOT23-3 Voltage References

ELECTRICAL CHARACTERISTICS—MAX6005

($V_{IN} = +5.5V$, $I_{OUT} = 0$, $T_A = T_{MIN}$ to T_{MAX} , unless otherwise noted. Typical values are at $T_A = +25^\circ C$.) (Note 1)

| PARAMETER | SYMBOL | CONDITIONS | MIN | TYP | MAX | UNITS |
|---|---|--|-----------------|-------|-------|--------------------|
| OUTPUT | | | | | | |
| Output Voltage | V_{OUT} | $T_A = +25^\circ C$ | 4.950 | 5.000 | 5.050 | V |
| Output Voltage Temperature Coefficient (Note 2) | TCV_{OUT} | | | 20 | 100 | ppm/ $^\circ C$ |
| Line Regulation | $\frac{\Delta V_{OUT}}{\Delta V_{IN}}$ | $(V_{OUT} + 0.2V) \leq V_{IN} \leq 12.6V$ | | 25 | 240 | $\mu V/V$ |
| Load Regulation | $\frac{\Delta V_{OUT}}{\Delta I_{OUT}}$ | Sourcing: $0 \leq I_{OUT} \leq 400\mu A$ | | 0.17 | 1.00 | $\mu V/\mu A$ |
| | | Sinking: $-400\mu A \leq I_{OUT} \leq 0$ | | 0.24 | 1.20 | |
| Dropout Voltage (Note 5) | $V_{IN} - V_{OUT}$ | $I_{OUT} = 400\mu A$ | | 100 | 200 | mV |
| OUT Short-Circuit Current | I_{SC} | Short to GND | | 4 | | mA |
| | | Short to IN | | 4 | | |
| Temperature Hysteresis (Note 3) | | | | 130 | | ppm |
| Long-Term Stability | $\frac{\Delta V_{OUT}}{\text{time}}$ | 1,000 hours at $T_A = +25^\circ C$ | | 50 | | ppm/ 1,000hrs |
| DYNAMIC | | | | | | |
| Noise Voltage | e_{OUT} | $f = 0.1\text{Hz to }10\text{Hz}$ | | 120 | | $\mu V\text{-p-p}$ |
| | | $f = 10\text{Hz to }10\text{kHz}$ | | 240 | | μV_{RMS} |
| Ripple Rejection | $\frac{\Delta V_{OUT}}{\Delta V_{IN}}$ | $V_{IN} = 5V \pm 100\text{mV}$, $f = 120\text{Hz}$ | | 72 | | dB |
| Turn-On Settling Time | t_R | To $V_{OUT} = 0.1\%$ of final value, $C_{OUT} = 50\text{pF}$ | | 220 | | μs |
| Capacitive-Load Stability Range | C_{OUT} | (Note 4) | 0 | | 2.2 | nF |
| INPUT | | | | | | |
| Supply Voltage Range | V_{IN} | Guaranteed by line-regulation test | $V_{OUT} + 0.2$ | | 12.6 | V |
| Quiescent Supply Current | I_{IN} | | | 27 | 45 | μA |
| Change in Supply Current | I_{IN}/V_{IN} | $(V_{OUT} + 0.2V) \leq V_{IN} \leq 12.6V$ | | 0.8 | 2.6 | $\mu A/V$ |

Note 1: All devices are 100% production tested at $T_A = +25^\circ C$ and are guaranteed by design for $T_A = T_{MIN}$ to T_{MAX} , as specified.

Note 2: Temperature coefficient is measured by the "box" method; i.e., the maximum ΔV_{OUT} is divided by the maximum Δt .

Note 3: Thermal hysteresis is defined as the change in $+25^\circ C$ output voltage before and after cycling the device from T_{MIN} to T_{MAX} .

Note 4: Not production tested. Guaranteed by design.

Note 5: Dropout voltage is the minimum input voltage at which V_{OUT} changes $\leq 0.2\%$ from V_{OUT} at $V_{IN} = 5.0V$ ($V_{IN} = 5.5V$ for MAX6005).

Low-Cost, Low-Power, Low-Dropout, SOT23-3 Voltage References

Typical Operating Characteristics

($V_{IN} = +5V$ for MAX6001–MAX6004, $V_{IN} = +5.5V$ for MAX6005; $I_{OUT} = 0$; $T_A = +25^\circ C$; unless otherwise noted.) (Note 6)

MAX6001–MAX6005

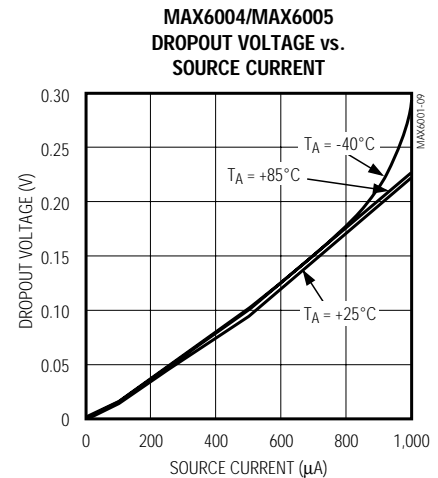
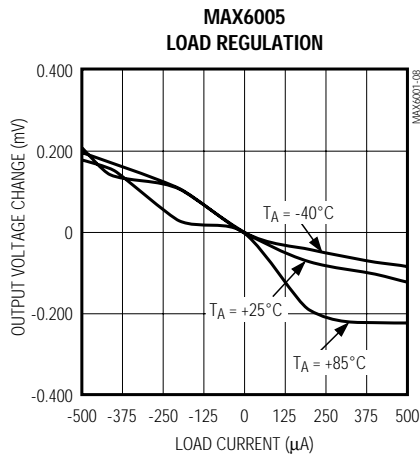
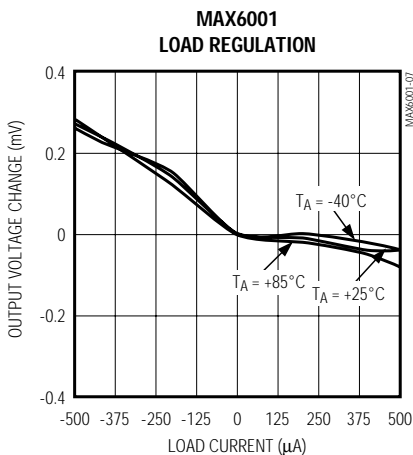
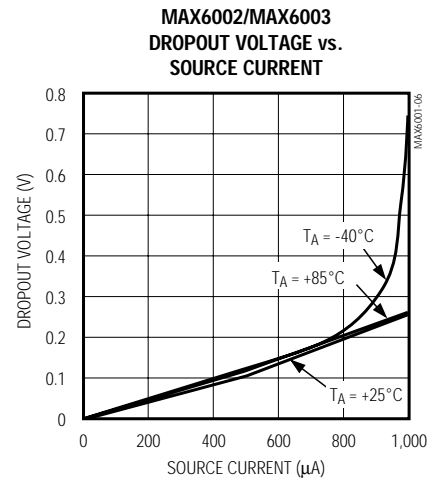
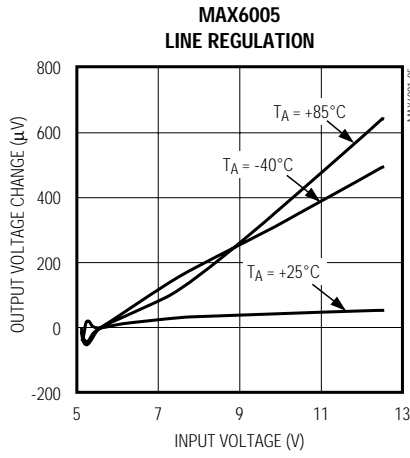
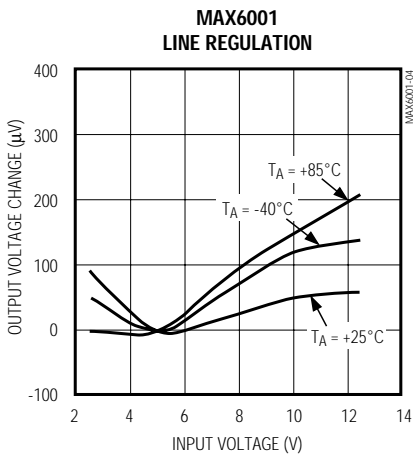
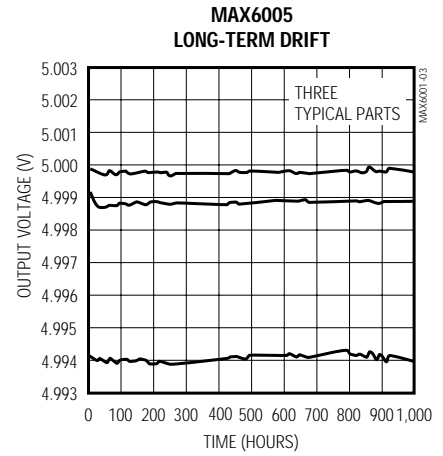
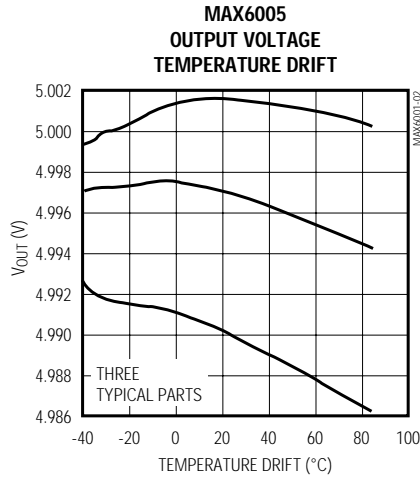
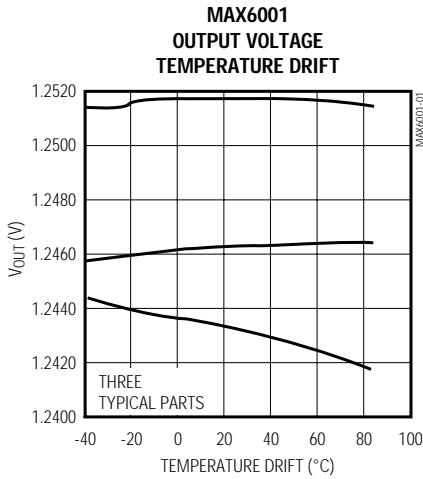

Low-Cost, Low-Power, Low-Dropout, SOT23-3 Voltage References

Typical Operating Characteristics (continued)

($V_{IN} = +5V$ for MAX6001-MAX6004, $V_{IN} = +5.5V$ for MAX6005; $I_{OUT} = 0$; $T_A = +25^\circ C$; unless otherwise noted.) (Note 6)

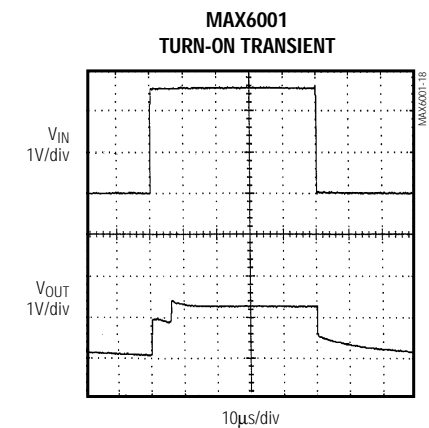
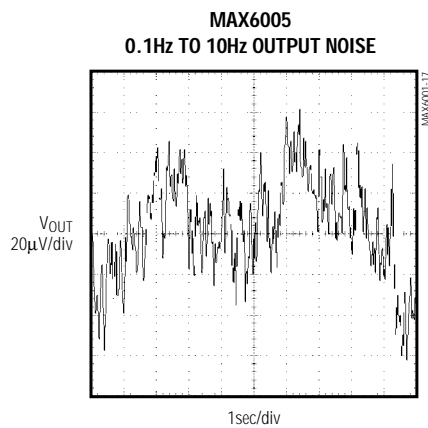
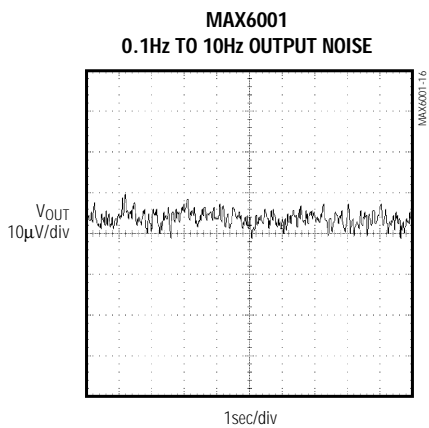
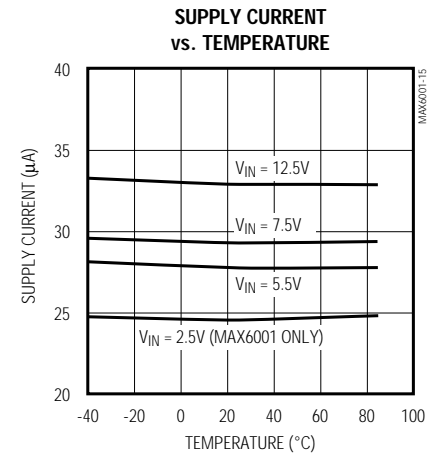
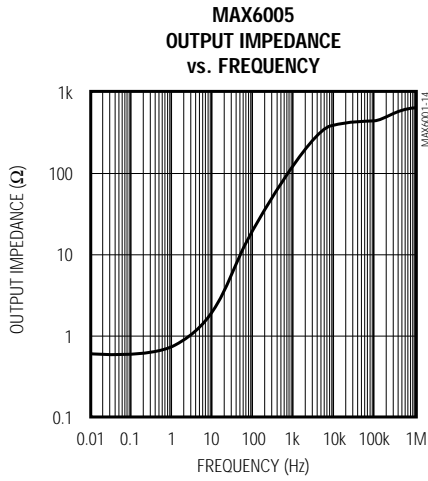
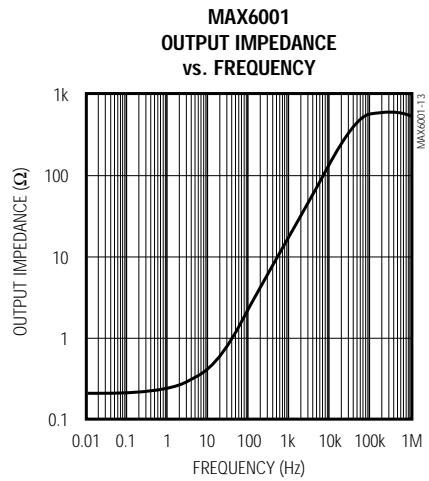
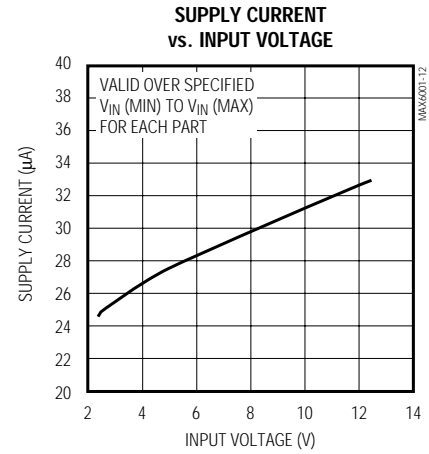
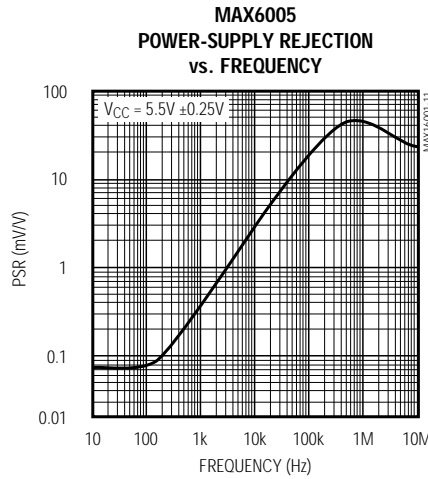
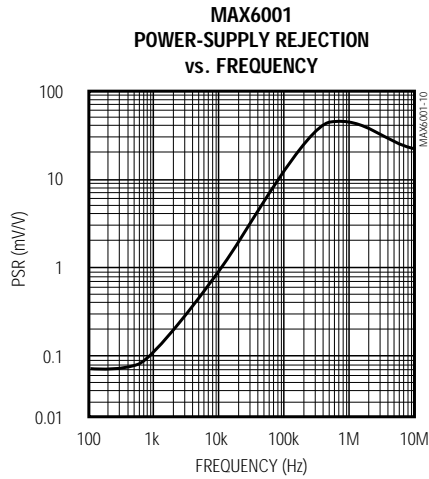

Low-Cost, Low-Power, Low-Dropout, SOT23-3 Voltage References

Typical Operating Characteristics (continued)

($V_{IN} = +5V$ for MAX6001–MAX6004, $V_{IN} = +5.5V$ for MAX6005; $I_{OUT} = 0$; $T_A = +25^\circ C$; unless otherwise noted.) (Note 6)

MAX6001–MAX6005

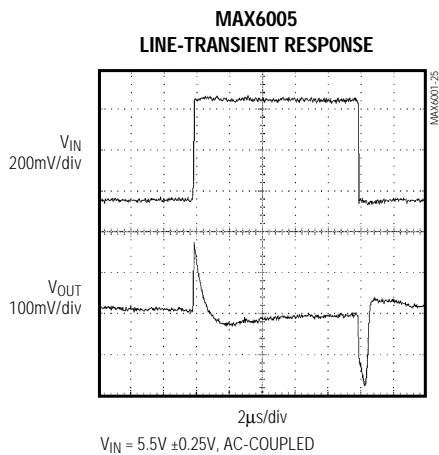
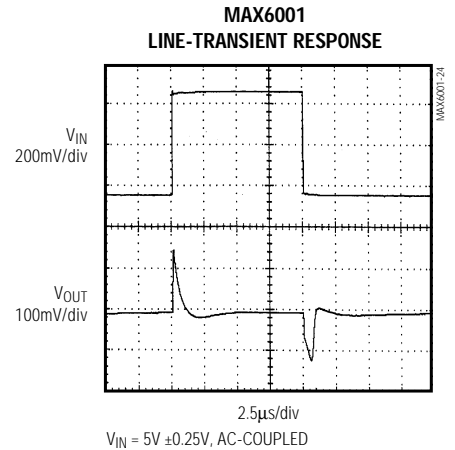
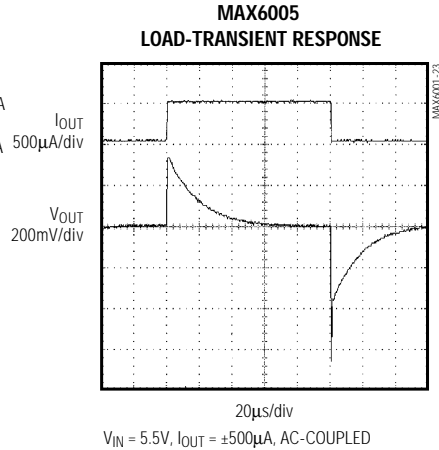
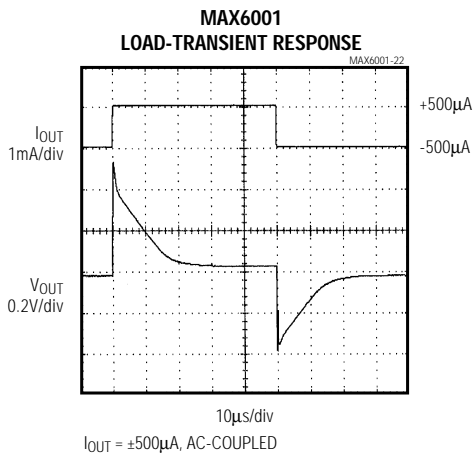
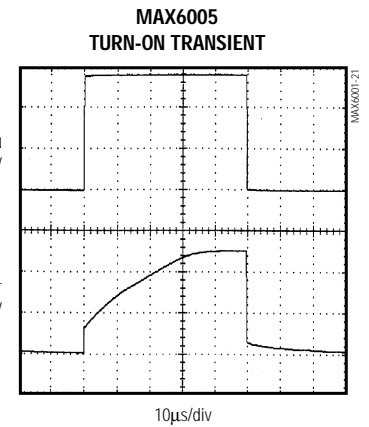
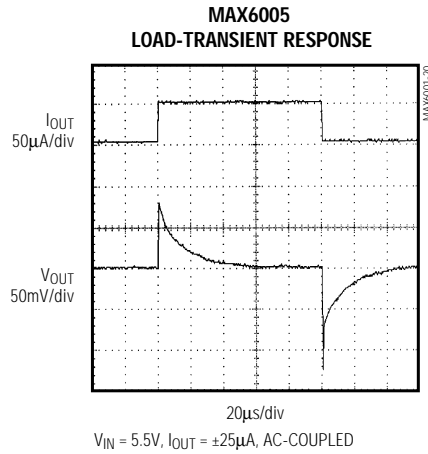
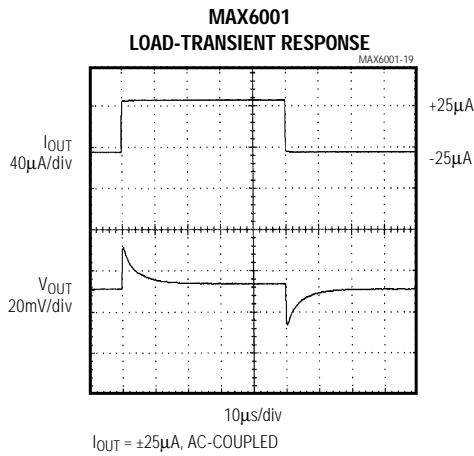

Note 6: Many of the *Typical Operating Characteristics* of the MAX6001 family are extremely similar. The extremes of these characteristics are found in the MAX6001 (1.2V output) and MAX6005 (5.0V output) devices. The *Typical Operating Characteristics* of the remainder of the MAX6001 family typically lie between these two extremes and can be estimated based on their output voltage.

Low-Cost, Low-Power, Low-Dropout, SOT23-3 Voltage References

Pin Description

| PIN | NAME | FUNCTION |
|-----|------|--------------------------|
| 1 | IN | Supply Voltage Input |
| 2 | OUT | Reference Voltage Output |
| 3 | GND | Ground |

Detailed Description

The MAX6001-MAX6005 bandgap references offer a temperature coefficient of <math><100\text{ppm}/^\circ\text{C}</math> and initial accuracy of better than 1%. These devices can sink and source up to 400 μA with <math><200\text{mV}</math> of dropout voltage, making them attractive for use in low-voltage applications.

Applications Information

Output/Load Capacitance

Devices in this family do not require an output capacitance for frequency stability. They are stable for capacitive loads from 0 to 2.2nF. However, in applications where the load or the supply can experience step changes, an output capacitor will reduce the amount of overshoot (or undershoot) and assist the circuit's transient response. Many applications do not need an external capacitor, and this family can offer a significant advantage in these applications when board space is critical.

Supply Current

The quiescent supply current of these series-mode references is a maximum of 45 μA and is virtually independent of the supply voltage, with only a 0.8 $\mu\text{A}/\text{V}$ variation with supply voltage. Unlike shunt-mode references, the load current of these series-mode references is drawn from the supply voltage only when required, so supply current is not wasted and efficiency is maximized over the entire supply voltage range. This improved efficiency can help reduce power dissipation and extend battery life.

When the supply voltage is below the minimum specified input voltage (as during turn-on), the devices can draw up to 200 μA beyond the nominal supply current. The input voltage source must be capable of providing this current to ensure reliable turn-on.

Output Voltage Hysteresis

Output voltage hysteresis is the change in the output voltage at $T_A = +25^\circ\text{C}$ before and after the device is cycled over its entire operating temperature range. Hysteresis is caused by differential package stress appearing across the bandgap core transistors. The typical temperature hysteresis value is 130ppm.

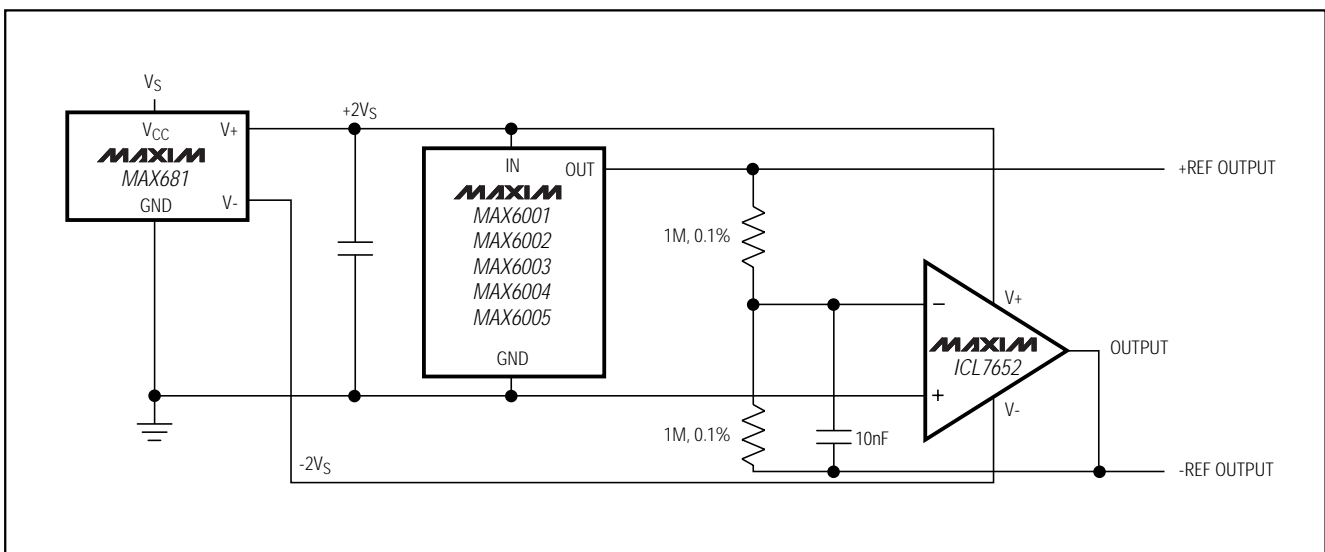

Figure 1. Positive and Negative References from Single +3V or +5V Supply

Low-Cost, Low-Power, Low-Dropout, SOT23-3 Voltage References

Turn-On Time

These devices typically turn on and settle to within 0.1% of their final value in 30 μ s to 220 μ s depending on the device. The turn-on time can increase up to 1.5ms with the device operating at the minimum dropout voltage and the maximum load.

Positive and Negative Low-Power Voltage Reference

Figure 1 shows a typical method for developing a bipolar reference. The circuit uses a MAX681 voltage doubler/inverter charge-pump converter to power an ICL7652, thus creating a positive as well as a negative reference voltage.

Chip Information

TRANSISTOR COUNT: 70

MAX6001-MAX6005

Low-Cost, Low-Power, Low-Dropout, SOT23-3 Voltage References

Package Information

NOTES:

1. D&E DO NOT INCLUDE MOLD FLASH.
2. MOLD FLASH OR PROTRUSIONS NOT TO EXCEED .15mm (.006")
3. CONTROLLING DIMENSION: MILLIMETER

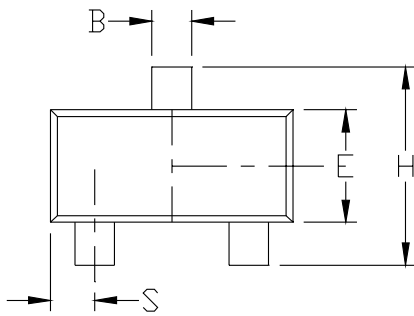

| DIM | INCHES | | MILLIMETERS | |
|----------|--------|-------|-------------|-------|
| | MIN | MAX | MIN | MAX |
| A | 0.031 | 0.047 | 0.787 | 1.194 |
| A1 | 0.001 | 0.005 | 0.025 | 0.127 |
| B | 0.014 | 0.022 | 0.356 | 0.559 |
| C | 0.0034 | 0.006 | 0.086 | 0.152 |
| D | 0.105 | 0.120 | 2.667 | 3.048 |
| E | 0.047 | 0.055 | 1.194 | 1.397 |
| e | 0.070 | 0.080 | 1.778 | 2.032 |
| H | 0.082 | 0.098 | 2.083 | 2.489 |
| L | 0.004 | 0.012 | 0.102 | 0.305 |
| S | 0.017 | 0.022 | 0.432 | 0.559 |
| α | 0° | 8° | 0° | 8° |

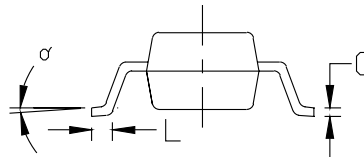
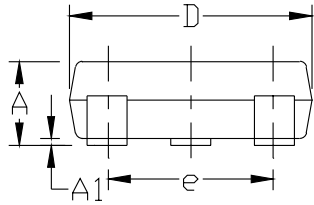

| | | |
|--|-------------------------------------|--------------------|
| MAXIM | | |
| <small>PROPRIETARY INFORMATION</small> | | |
| <small>TITLE:</small> | | |
| PACKAGE OUTLINE, SOT-23, 3L | | |
| <small>APPROVAL</small> | <small>DOCUMENT CONTROL NO.</small> | <small>REV</small> |
| | 21-0051 | C 1/1 |

SOT23-3L EPS

Maxim cannot assume responsibility for use of any circuitry other than circuitry entirely embodied in a Maxim product. No circuit patent licenses are implied. Maxim reserves the right to change the circuitry and specifications without notice at any time.

12 Maxim Integrated Products, 120 San Gabriel Drive, Sunnyvale, CA 94086 408-737-7600