



Optocoupler, Phototransistor Output, AC Input, With Base Connection

Features

- AC or Polarity Insensitive Input
- Built-in Reverse Polarity Input Protection
- Improved CTR Symmetry
- Industry Standard DIP Package

Agency Approvals

- UL File #E52744 System Code H or J
- CSA 93751
- BSI IEC60950 IEC60965

- DIN EN 60747-5-2(VDE0884)
- DIN EN 60747-5-5 pending
- Available with Option 1

Applications

Ideal for AC signal detection and monitoring.

Description

The IL250/ 251/ 252/ ILD250/ 251/ 252 are bidirectional input optically coupled isolators consisting of two Gallium Arsenide infrared LEDs coupled to a silicon NPN phototransistor per channel.

The IL250/ ILD/250 has a minimum CTR of 50 %, the IL251/ ILD251 has a minimum CTR of 20 %, and the IL252/ ILD252 has a minimum CTR of 100 %. The IL250/ IL251/ IL252 are single channel optocouplers. The ILD250/ ILD251/ ILD252 has two isolated channels in a single DIP package.

Single Channel

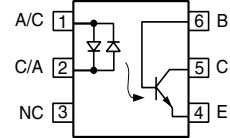
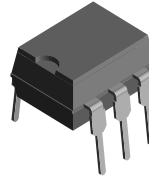

Dual Channel

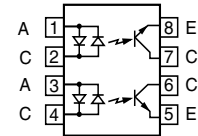
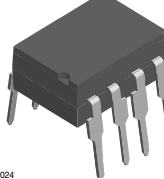

i179024

Order Information

| Part | Remarks |
|-------------|---|
| IL250 | CTR > 50 %, Single Channel DIP-6 |
| IL251 | CTR > 20 %, Single Channel DIP-6 |
| IL252 | CTR > 100 %, Single Channel DIP-6 |
| ILD250 | CTR > 50 %, Dual Channel DIP-8 |
| ILD251 | CTR > 20 %, Dual Channel DIP-8 |
| ILD252 | CTR > 100 %, Dual Channel DIP-8 |
| IL250-X007 | CTR > 50 %, Single Channel SMD-6 (option 7) |
| IL250-X009 | CTR > 50 %, Single Channel SMD-6 (option 9) |
| IL251-X009 | CTR > 20 %, Single Channel SMD-6 (option 9) |
| IL252-X007 | CTR > 100 %, Single Channel SMD-6 (option 7) |
| IL252-X009 | CTR > 100 %, Single Channel SMD-6 (option 9) |
| ILD250-X009 | CTR > 50 %, Dual Channel SMD-6 (option 9) |
| ILD251-X006 | CTR > 20 %, Dual Channel DIP-8 400 mil (option 6) |
| ILD251-X007 | CTR > 20 %, Dual Channel SMD-6 (option 7) |
| ILD251-X009 | CTR > 20 %, Dual Channel SMD-6 (option 9) |
| ILD252-X009 | CTR > 100 %, Dual Channel SMD-6 (option 9) |

For additional information on the available options refer to Option Information.

Absolute Maximum Ratings

$T_{amb} = 25\text{ °C}$, unless otherwise specified

Stresses in excess of the absolute Maximum Ratings can cause permanent damage to the device. Functional operation of the device is not implied at these or any other conditions in excess of those given in the operational sections of this document. Exposure to absolute Maximum Rating for extended periods of the time can adversely affect reliability.

Input

| Parameter | Test condition | Symbol | Value | Unit |
|----------------------------|----------------|------------|-------|-------|
| Forward continuous current | | I_F | 60 | mA |
| Power dissipation | | P_{diss} | 100 | mW |
| Derate linearly from 25 °C | | | 1.33 | mw/°C |

Output

| Parameter | Test condition | Symbol | Value | Unit |
|---|----------------|------------|-------|-------|
| Collector-emitter breakdown voltage | | BV_{CEO} | 30 | V |
| Emitter-base breakdown voltage | | BV_{EBO} | 5.0 | V |
| Collector-base breakdown voltage | | BV_{CBO} | 70 | V |
| Power dissipation single channel | | P_{diss} | 200 | mW |
| Power dissipation dual channel | | P_{diss} | 150 | mW |
| Derate linearly from 25 °C single channel | | | 2.6 | mW/°C |
| Derate linearly from 25 °C dual channel | | | 2.0 | mW/°C |

Coupler

| Parameter | Test condition | Symbol | Value | Unit |
|--|--|-----------|---------------|-----------|
| Isolation test voltage (between emitter and detector referred to standard climate 23 °C/50 %RH, DIN 50014) | | V_{ISO} | 5300 | V_{RMS} |
| Creepage | | | ≥ 7.0 | mm |
| Clearance | | | ≥ 7.0 | mm |
| Isolation resistance | $V_{IO} = 500\text{ V}, T_{amb} = 25\text{ °C}$ | R_{IO} | 10^{12} | Ω |
| | $V_{IO} = 500\text{ V}, T_{amb} = 100\text{ °C}$ | R_{IO} | 10^{11} | Ω |
| Total dissipation single channel | | P_{tot} | 250 | mW |
| Total dissipation dual channel | | P_{tot} | 400 | mW |
| Derate linearly from 25 °C single channel | | | 3.3 | mW/°C |
| Derate linearly from 25 °C dual channel | | | 5.3 | mW/°C |
| Storage temperature | | T_{stg} | - 55 to + 150 | °C |
| Operating temperature | | T_{amb} | - 55 to + 100 | °C |
| Lead soldering time at 260 °C | | | 10 | sec. |

Electrical Characteristics

$T_{amb} = 25\text{ }^{\circ}\text{C}$, unless otherwise specified

Minimum and maximum values are testing requirements. Typical values are characteristics of the device and are the result of engineering evaluation. Typical values are for information only and are not part of the testing requirements.

Input

| Parameter | Test condition | Symbol | Min | Typ. | Max | Unit |
|-----------------|--------------------------|--------|-----|------|-----|------|
| Forward voltage | $I_F = \pm 10\text{ mA}$ | V_F | | 1.2 | 1.5 | V |

Output

| Parameter | Test condition | Symbol | Min | Typ. | Max | Unit |
|-------------------------------------|--------------------------------|------------|-----|------|-----|------|
| Collector-emitter breakdown voltage | $I_C = 1.0\text{ mA}$ | BV_{CEO} | 30 | 50 | | V |
| Emitter-base breakdown voltage | $I_E = 100\text{ }\mu\text{A}$ | BV_{EBO} | 7.0 | 10 | | V |
| Collector-base breakdown voltage | $I_C = 10\text{ }\mu\text{A}$ | BV_{CBO} | 70 | 90 | | V |
| Collector-emitter leakage current | $V_{CE} = 10\text{ V}$ | I_{CEO} | | 5.0 | 50 | nA |

Coupler

| Parameter | Test condition | Symbol | Min | Typ. | Max | Unit |
|--------------------------------------|--|-------------|-----|------|-----|------|
| Collector-emitter saturation voltage | $I_F = \pm 16\text{ mA}$, $I_C = 2.0\text{ mA}$ | V_{CEsat} | | | 0.4 | V |

Current Transfer Ratio

| Parameter | Test condition | Part | Symbol | Min | Typ. | Max | Unit |
|--|---|--------|------------|------|------|-----|------|
| DC Current Transfer Ratio | $I_F = \pm 10\text{ mA}$, $V_{CE} = 10\text{ V}$ | ILD250 | CTR_{DC} | 50 | | | % |
| | | ILD251 | CTR_{DC} | 20 | | | % |
| | | ILD252 | CTR_{DC} | 100 | | | % |
| Symmetry (CTR @ +10 mA)/ (CTR @ -10 mA) | | | | 0.50 | 1.0 | 2.0 | |

Typical Characteristics ($T_{amb} = 25\text{ }^{\circ}\text{C}$ unless otherwise specified)

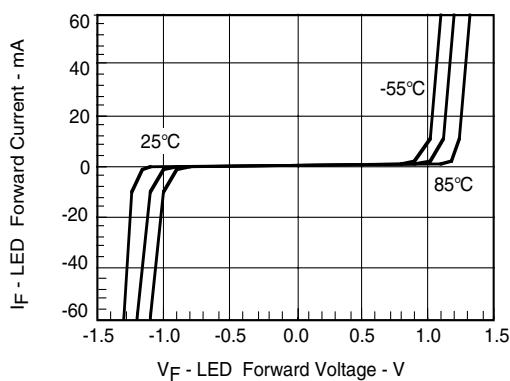

IL250_01

Fig. 1 LED Forward Current vs. Forward Voltage

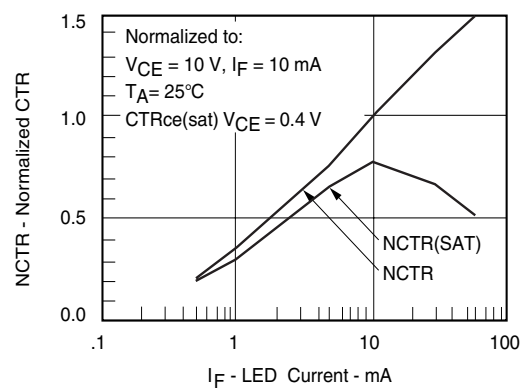

IL250_02

Fig. 2 Normalized Non-Saturated and Saturated CTR vs. LED Current

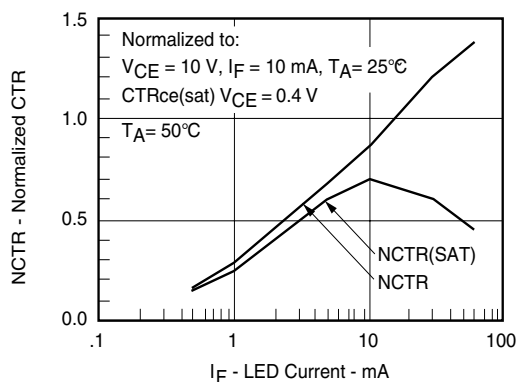

250_03

Fig. 3 Normalized Non-saturated and Saturated CTR vs. LED Current

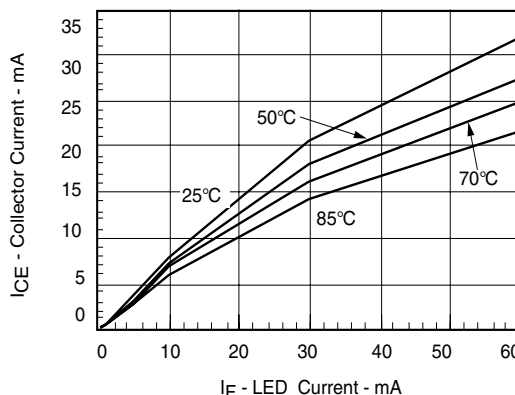

250_06

Fig. 6 Collector-Emitter Current vs. Temperature and LED Current

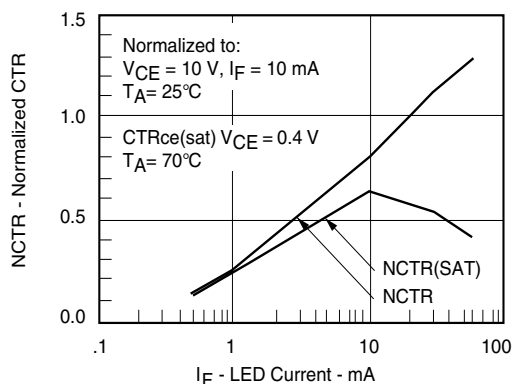

250_04

Fig. 4 Normalized Non-saturated and saturated CTR vs. LED Current

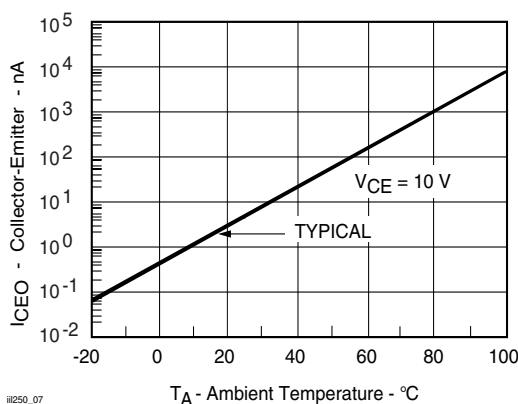

250_07

Fig. 7 Collector-Emitter Leakage Current vs. Temp.

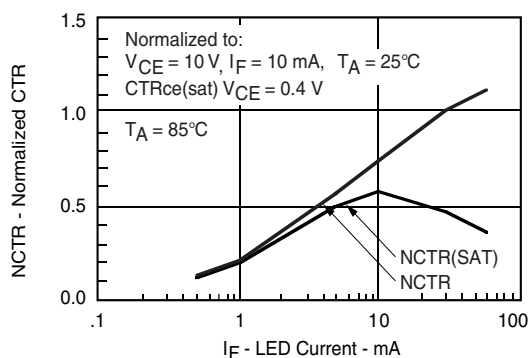

250_05

Fig. 5 Normalized Non-saturated and saturated CTR vs. LED Current

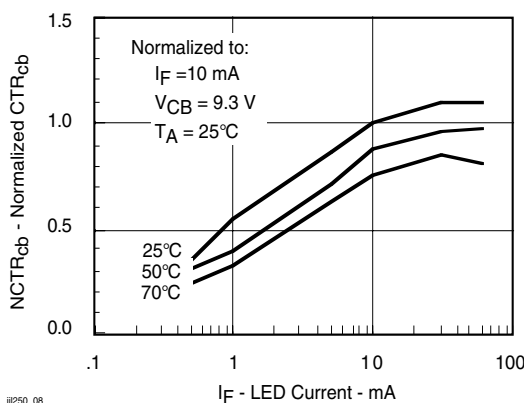

250_08

Fig. 8 Normalized CTR_{cb} vs. LED Current and Temperature

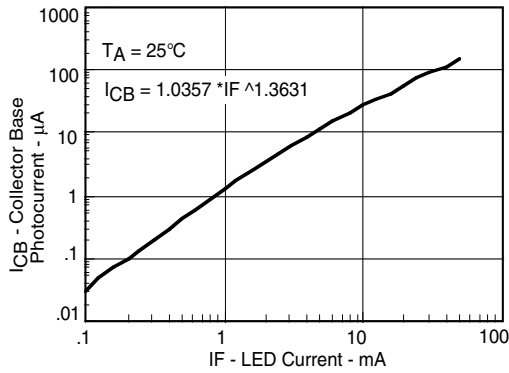

#250_09

Fig. 9 Collector-Base Photocurrent vs. LED Current

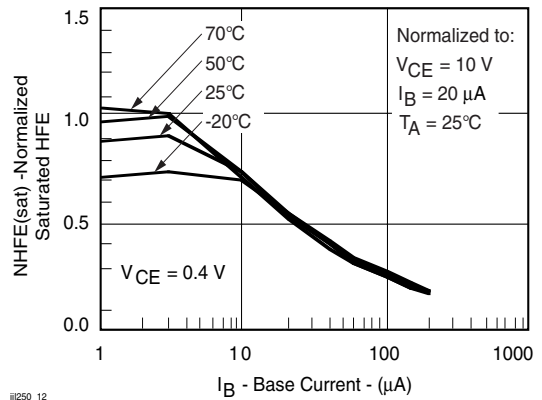

#250_12

Fig. 12 Normalized Saturated HFE vs. Base Current and Temperature

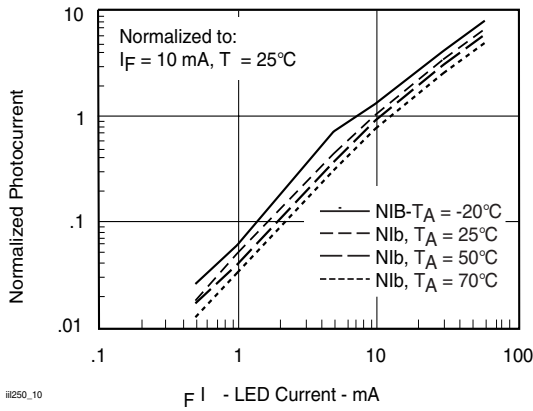

#250_10

Fig. 10 Normalized Photocurrent vs. I_F and Temp.

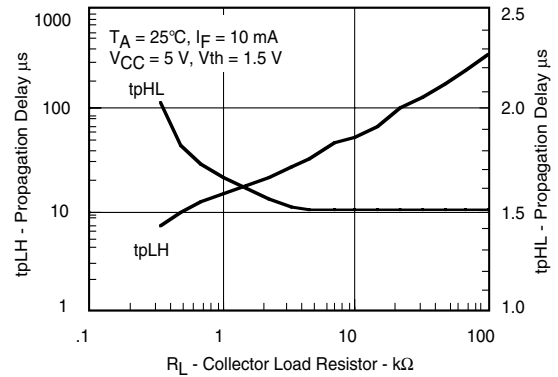

#250_13

Fig. 13 Propagation Delay vs. Collector Load Resistor

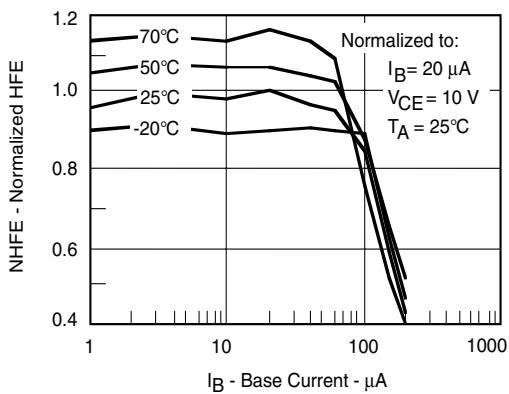

#250_11

Fig. 11 Normalized Non-saturated HFE vs. Base Current and Temperature

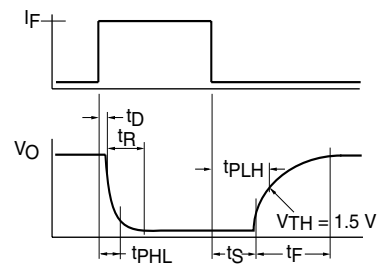

#250_14

Fig. 14 Switching Timing

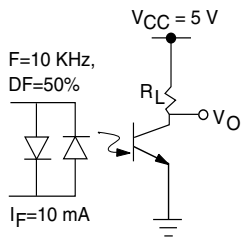

il250_15

Fig. 15 Switching Schematic

Package Dimensions in Inches (mm)

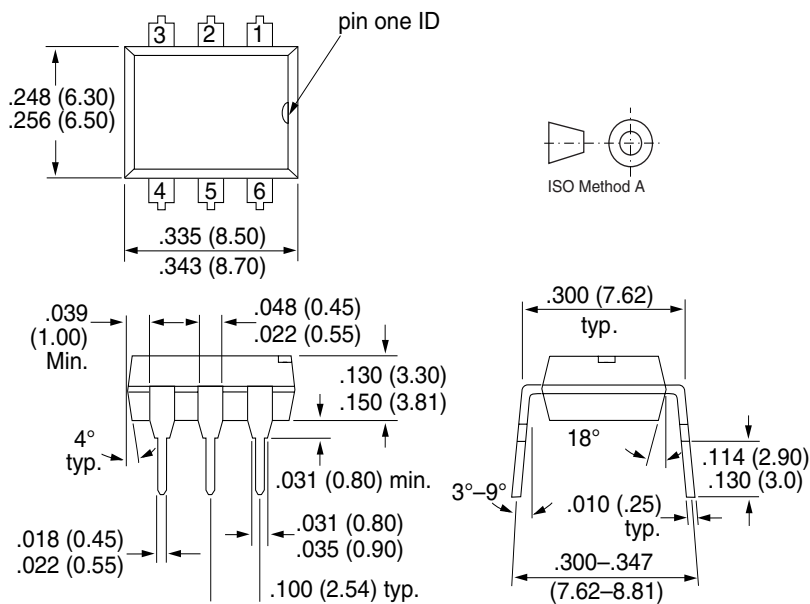

i178004



Package Dimensions in Inches (mm)

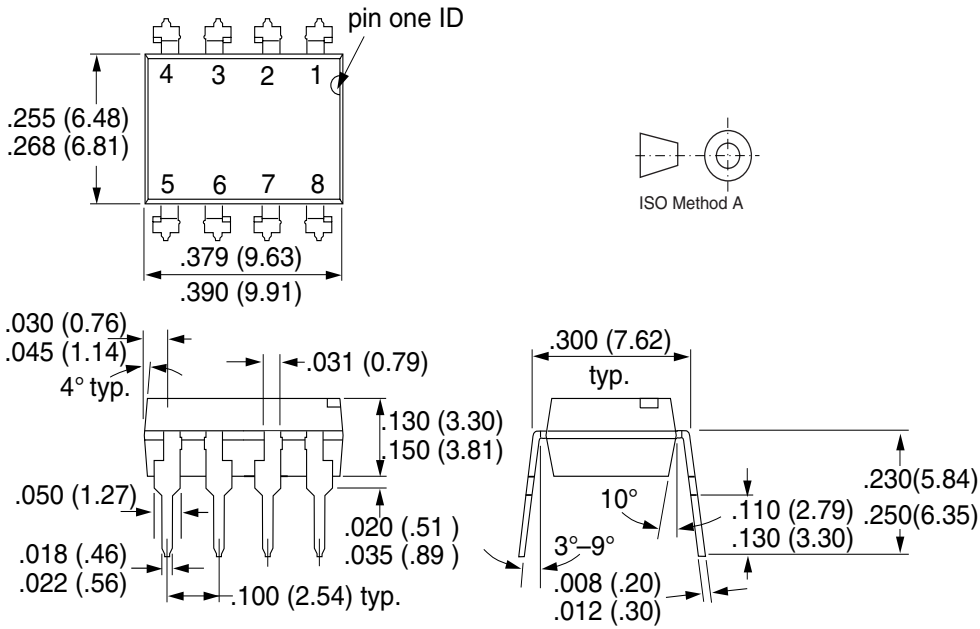

i178006

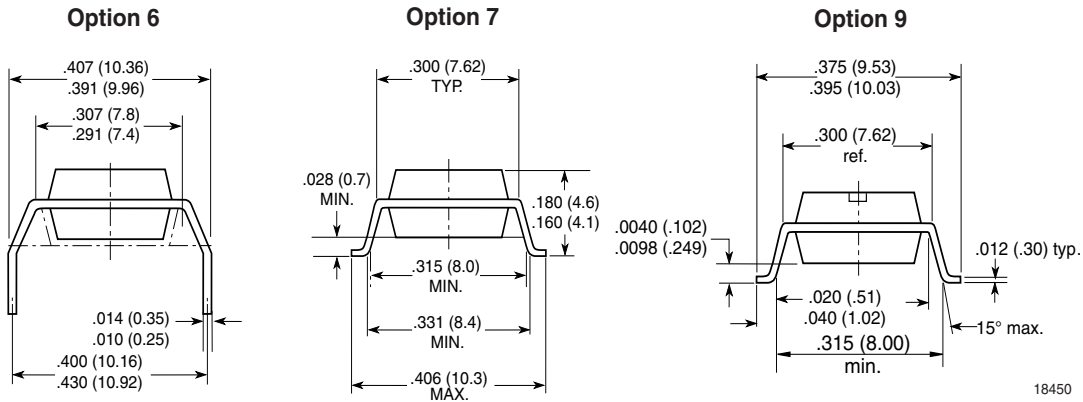

18450

Vishay Semiconductors

Ozone Depleting Substances Policy Statement

It is the policy of **Vishay Semiconductor GmbH** to

1. Meet all present and future national and international statutory requirements.
2. Regularly and continuously improve the performance of our products, processes, distribution and operating systems with respect to their impact on the health and safety of our employees and the public, as well as their impact on the environment.

It is particular concern to control or eliminate releases of those substances into the atmosphere which are known as ozone depleting substances (ODSs).

The Montreal Protocol (1987) and its London Amendments (1990) intend to severely restrict the use of ODSs and forbid their use within the next ten years. Various national and international initiatives are pressing for an earlier ban on these substances.

Vishay Semiconductor GmbH has been able to use its policy of continuous improvements to eliminate the use of ODSs listed in the following documents.

1. Annex A, B and list of transitional substances of the Montreal Protocol and the London Amendments respectively
2. Class I and II ozone depleting substances in the Clean Air Act Amendments of 1990 by the Environmental Protection Agency (EPA) in the USA
3. Council Decision 88/540/EEC and 91/690/EEC Annex A, B and C (transitional substances) respectively.

Vishay Semiconductor GmbH can certify that our semiconductors are not manufactured with ozone depleting substances and do not contain such substances.

**We reserve the right to make changes to improve technical design
and may do so without further notice.**

Parameters can vary in different applications. All operating parameters must be validated for each customer application by the customer. Should the buyer use Vishay Semiconductors products for any unintended or unauthorized application, the buyer shall indemnify Vishay Semiconductors against all claims, costs, damages, and expenses, arising out of, directly or indirectly, any claim of personal damage, injury or death associated with such unintended or unauthorized use.

Vishay Semiconductor GmbH, P.O.B. 3535, D-74025 Heilbronn, Germany
Telephone: 49 (0)7131 67 2831, Fax number: 49 (0)7131 67 2423