

### General Description

The MIC2141 is a micropower boost switching regulator that can operate from 3- or 4-cell nickel-metal-hydride batteries or a single Li-ion cell. This regulator employs a constant 330kHz, fixed 18% duty-cycle, gated-oscillator architecture.

The MIC2141 can be used in applications where the output voltage must be dynamically adjusted. The device features a control signal input which is used to proportionally adjust the output voltage. The control signal input has a gain of 6, allowing a 0.8V to 3.6V control signal to vary a 4.8V to 22V output.

The MIC2141 requires only three external components to operate and is available in a tiny 5-lead SOT-23 package for space and power-sensitive portable applications. The MIC2141 draws only 70µA of quiescent current and can operate with an efficiency exceeding 85%.

### Features

- Implements low-power boost, SEPIC, or flyback
- 2.5V to 14V input voltage
- 330kHz switching frequency
- <2µA shutdown current
- 70µA quiescent current
- 1.24V bandgap reference
- typical output current 1mA to 10mA
- SOT-23-5 Package

### Applications

- LCD bias supply
- CCD digital camera supply

### Ordering Information

Part Number	Junction Temp. Range	Package
MIC2141-BM5	-40°C to +85°C	SOT-23-5

### Typical Application

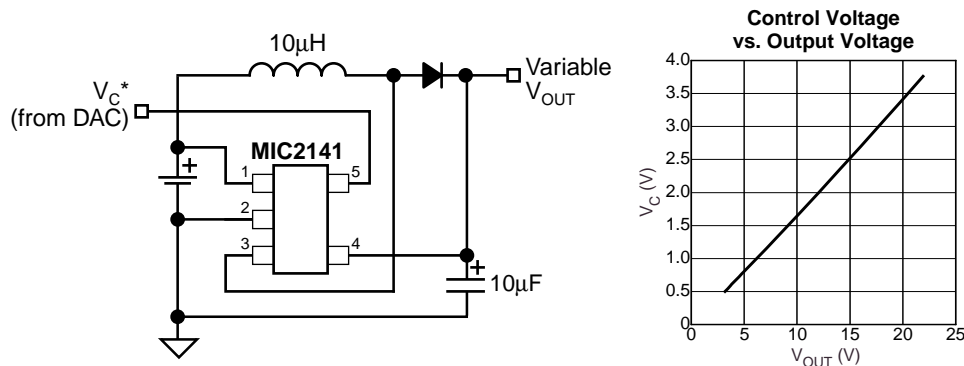

DAC-Controlled LCD Bias Voltage Supply

## Pin Configuration

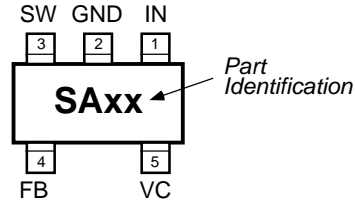

**SOT-23-5 (BM)**

## Pin Description

Pin Number	Pin Name	Pin Function
1	IN	Input: +2.5V to +14V supply for internal circuitry.
2	GND	Ground: Return for internal circuitry and internal MOSFET (switch) source.
3	SW	Switch Node (Input): Internal MOSFET drain; 22V maximum.
4	FB	Feedback (Input): Output voltage sense node. Compared to $V_C$ control input voltage.
5	VC	Control (Input): Output voltage control signal input. Input voltage of 0.8V to 3.6V is proportional to 4.8V to 22V output voltage (gain of 6). If the pin is not connected, the output voltage will be $V_{IN} - 0.5V$ .

**Absolute Maximum Ratings (Note 1)**

Supply Voltage ( $V_{IN}$ ) .....	+18V
Switch Voltage ( $V_{SW}$ ) .....	+24V
Feedback Voltage ( $F_B$ ) .....	+24V
Control Input Voltage ( $V_C$ ), <b>Note 3</b> ..	$V_{IN} - 200\text{mV} \leq V_C \leq 4\text{V}$
ESD Rating, <b>Note 4</b> .....	2kV

**Operating Ratings (Note 2)**

Supply Voltage ( $V_{IN}$ ) .....	+2.5V to +14V
Switch Voltage ( $V_{SW}$ ) .....	+3V to +22V
Ambient Temperature ( $T_A$ ) .....	-40°C to +85°C
Junction Temperature ( $T_J$ ) .....	-40°C to +125°C
Package Thermal Resistance	
SOT-23-5 ( $\theta_{JA}$ ) .....	220°C/W

**Electrical Characteristics**

$V_{IN} = 3.6\text{V}$ ,  $V_{OUT} = 5\text{V}$ ;  $I_{OUT} = 1\text{mA}$ ;  $T_J = 25^\circ\text{C}$ , bold values indicate  $-40^\circ\text{C} \leq T_A \leq +85^\circ\text{C}$ ; unless noted.

Parameter	Condition	Min	Typ	Max	Units
Input Voltage		2.5		14	V
Quiescent Current	Switch off, $V_{IN} = 3.6\text{V}$		70	100	$\mu\text{A}$
Comparator Hysteresis			10		mV
Control Voltage Gain ( $V_{OUT}/V_C$ )	$2.5\text{V} \leq V_{IN} \leq 12\text{V}$ , $V_{OUT} = 15\text{V}$		6		
Controlled Output Voltage, Note 3	$V_C = 0.8\text{V}$ ; $2.5\text{V} \leq V_{IN} \leq 4.2\text{V}$	4.85	5.0	5.15	V
	$V_C = 2.5\text{V}$ ; $2.7\text{V} \leq V_{IN} \leq 12\text{V}$	14.55	15.0	15.45	V
	$V_C = 3.4\text{V}$ ; $3.6\text{V} \leq V_{IN} \leq 12\text{V}$	19.4	20.0	20.6	V
Load Regulation	$100\mu\text{A} \leq I_{OUT} \leq 1\text{mA}$ , $V_{OUT} = 15\text{V}$		0.25	1	%
Line Regulation	$2.5\text{V} \leq V_{IN} \leq 12\text{V}$ ; $I_{OUT} \leq 1\text{mA}$		0.05	0.2	%/V
Switch On-Resistance	$I_{SW} = 100\text{mA}$ , $V_{IN} = 3.6\text{V}$		4		$\Omega$
	$I_{SW} = 100\text{mA}$ , $V_{IN} = 12\text{V}$		2.5		$\Omega$
Oscillator Frequency		300	330	360	kHz
Oscillator Duty Cycle		15	18		%

Note 1. Exceeding the absolute maximum rating may damage the device.

Note 2. The device is not guaranteed to function outside its operating rating.

Note 3.  $V_C = 4\text{V}$  sets  $V_{OUT}$  to 24V (absolute maximum level on  $V_{SW}$ );  $V_C$  must be  $\leq V_{IN} - 200\text{mV}$ .

Note 4. Devices are ESD sensitive. Handling precautions recommended. Human body model, 1.5k in series with 100pF.

# Typical Characteristics

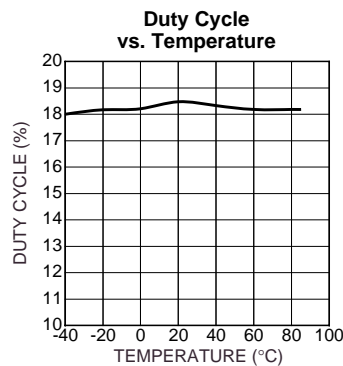
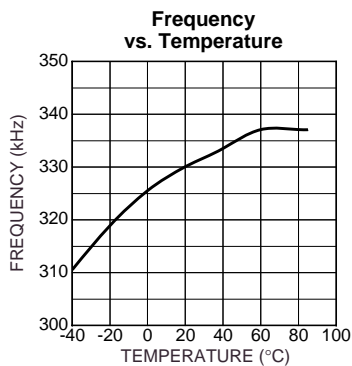
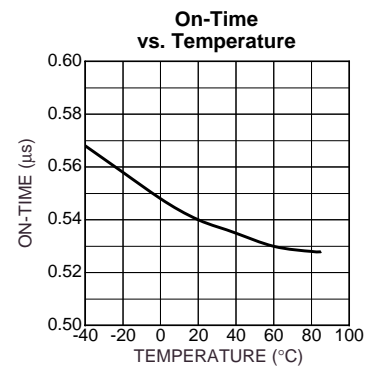
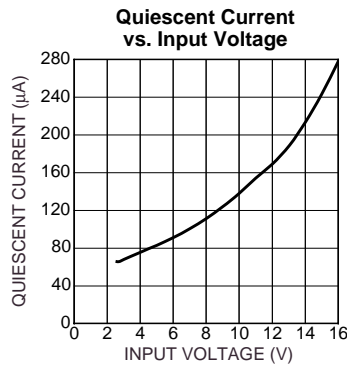
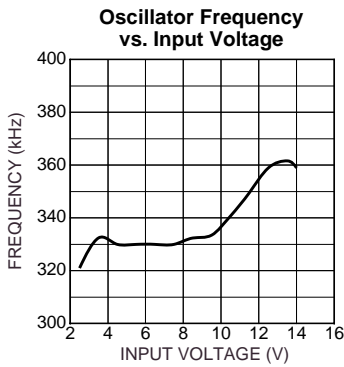
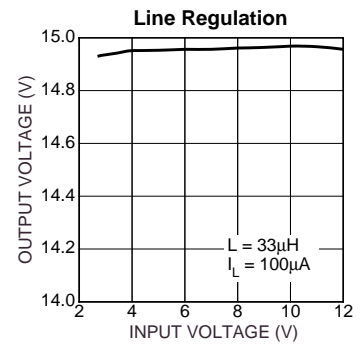
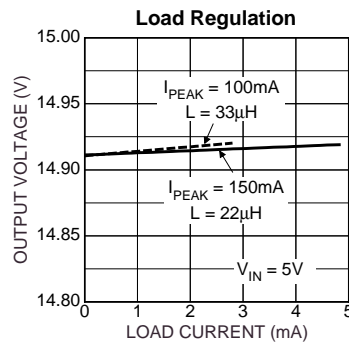
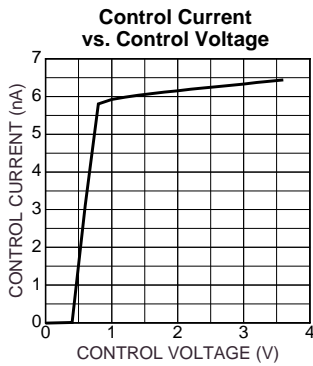
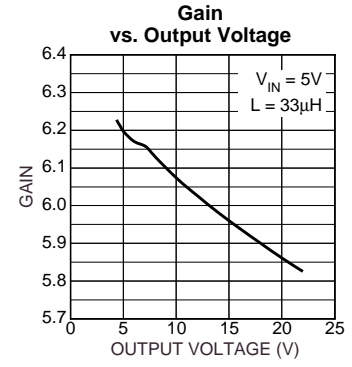
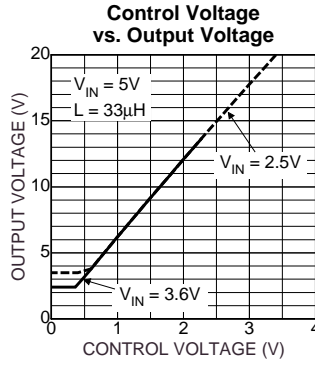
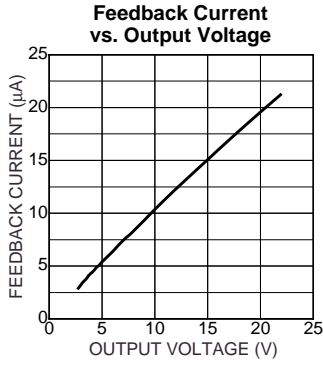

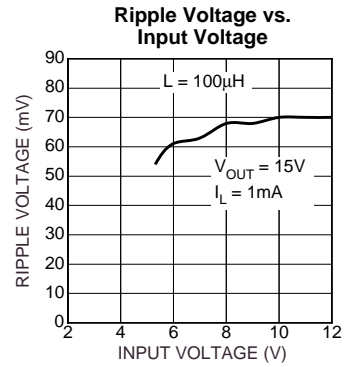
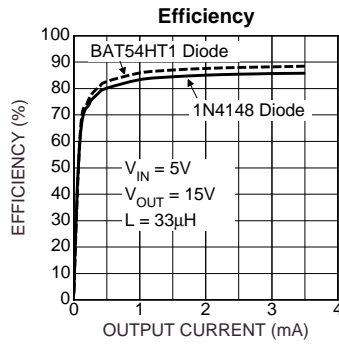
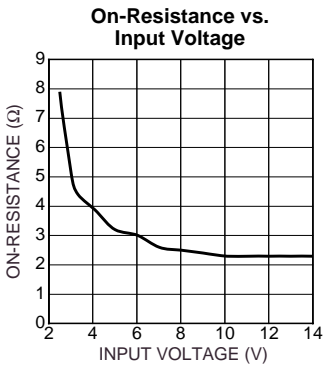
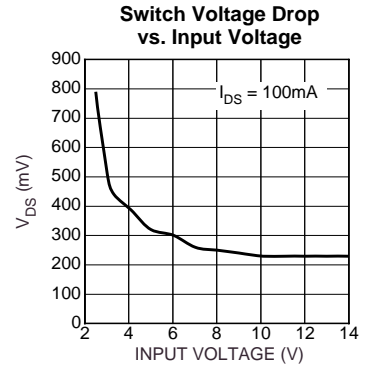
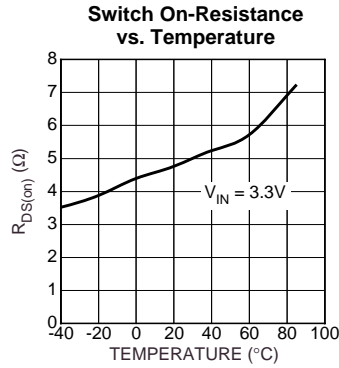
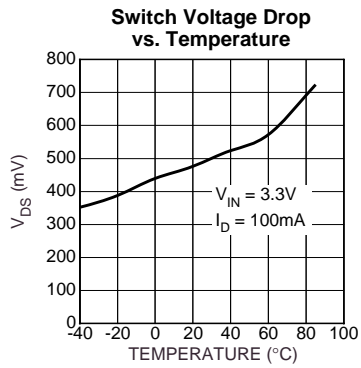
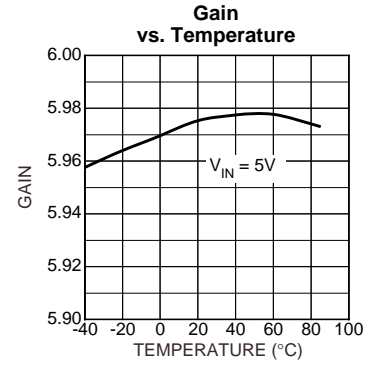
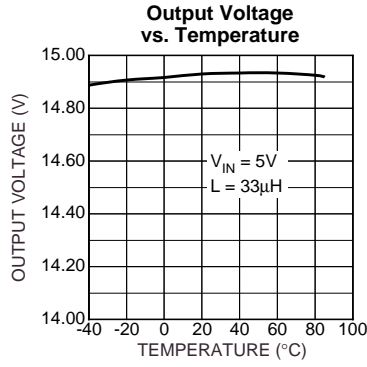
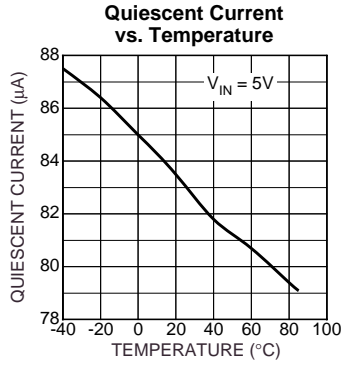

## Functional Diagram

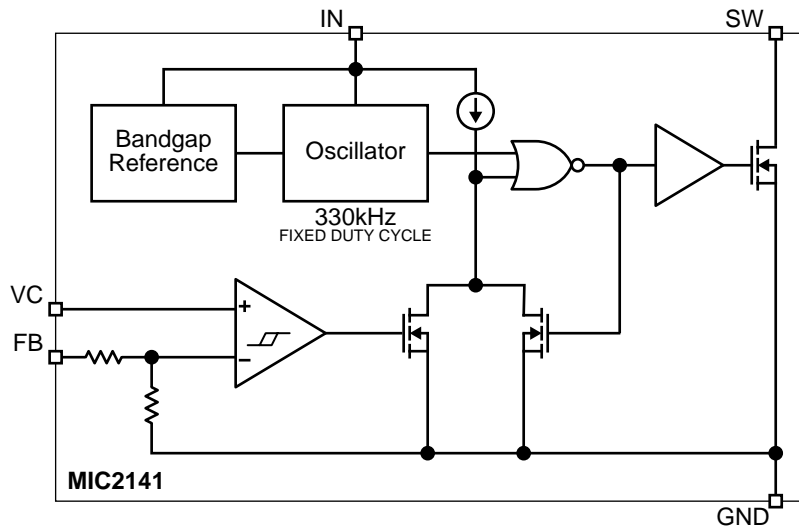

## Functional Description

See “Applications Information” for component selection and predesigned circuits.

### Overview

This MIC2141 is a fixed-duty-cycle, constant-frequency, gated-oscillator, micropower, switch-mode power supply controller. Quiescent current for the MIC2141 is only 70 $\mu$ A in the switch off state, and since a MOSFET output switch is used, additional current needed for switch drive is minimized. Efficiencies above 85% throughout most operating conditions can be realized.

### Regulator

Regulation is performed by a hysteretic comparator which regulates the output voltage by gating the internal oscillator. The user applies a programming voltage to the VC pin. (For a fixed or adjustable output regulator, with an internal reference, use the MIC2142.) The output voltage is divided down internally and then compared to the  $V_C$ , the control input voltage, forcing the output voltage to 6 times the  $V_C$ . The comparator has hysteresis built into it, which determines the amount of low frequency ripple that will be present on the output. Once the feedback input to the comparator exceeds the control voltage by 10mV, the high-frequency oscillator drive is removed from the output switch. As the feedback input to the comparator returns to the control voltage level, the comparator is reset and the high-frequency oscillator is again gated to the output switch. Typically 10mV of hysteresis seen at the comparator will correspond to 60mV of low-frequency ripple at the output. Applications, which require continuous adjustment of the output voltage, can do so by adjustment of the VC control pin.

### Output

The maximum output voltage is limited by the voltage capability of the output switch. Output voltages up to 22V can be achieved with a standard boost circuit. Higher output voltages require a flyback configuration.

### Output Voltage Control

The internal hysteretic comparator disables the output drive once the output voltage exceeds the nominal by 30mV. The drive is then enabled once the output voltage drops below the nominal by 30mV.

The reference level, which actually programs the output voltage, is set by the VC control input. The output is 6 times the control voltage ( $V_C$ ) and the output ripple will be 6 times the comparator hysteresis. Therefore, with 10mV of hysteresis, there will be  $\pm 30$ mV variation in the output around the nominal value. See the “Typical Characteristics: Control Voltage vs. Output Voltage” for a graph of input-to-output behavior.

The common-mode range of the comparator requires that the maximum control voltage ( $V_C$ ) be held to 200mV less than  $V_{IN}$ . When programming for a 20V output, a minimum  $V_{IN}$  of 3.5V will be required. See the “Typical Characteristics: Gain vs. Output Voltage” for a graph of gain behavior. To achieve 20V output at lower input voltages, the external resistive divider (R1 and R2) shown in Figure 2 can be added. This circuit will increase the control-to-output gain, while limiting the error introduced by the tolerance of the internal resistor feedback network.

## Application Information

Pre-designed circuit information is at the end of this section.

### Component Selection

#### Boost Inductor

Maximum power is delivered to the load when the oscillator is gated on 100% of the time. Total output power and circuit efficiency must be considered when determining the maximum inductor. The largest inductor possible is preferable in order to minimize the peak current and output ripple. Efficiency can vary from 80% to 90% depending upon input voltage, output voltage, load current, inductor, and output diode.

Equation 1 solves for the output current capability for a given inductor value and expected efficiency. Figures 5 through 9 graph estimates for maximum output current, assuming the minimum duty cycle, maximum frequency, and 85% efficiency. To determine the required inductance, find the intersection between the output voltage and current and select the value of the inductor curve just above the intersection. If the efficiency is expected to be other than the 85% used for the graph, Equation 1 can then be used to better determine the maximum output capability.

$$(1) \quad I_{O(\max)} = \frac{(V_{IN(\min)} t_{ON})^2}{2L_{MAX} T_S} \times \frac{1}{\frac{V_O}{\text{eff}} - V_{IN(\min)}}$$

The peak inductor and switch current can be calculated from Equation 2 or read from the graph in Figure 10. The peak current shown in Figure 10 is derived assuming a maximum duty cycle and a minimum frequency. The selected inductor and diode peak current capability must exceed this value. The peak current seen by the inductor is calculated at the maximum input voltage. A wider input voltage range will result in a higher worst-case peak current in the inductor. This effect can be seen in Table 4 by comparing the difference between the peak current at  $V_{IN(\min)}$  and  $V_{IN(\max)}$ .

$$(2) \quad I_{PK} = \frac{t_{ON(\max)} V_{IN(\max)}}{L_{MIN}}$$

#### DCM/CCM Boundary

Equation 3 solves for the point at which the inductor current will transition from DCM (discontinuous conduction mode) to

V <sub>OUT</sub>	V <sub>IN(CCM)</sub>
3.3V	3.04V
5.0V	4.40V
9.0V	7.60V
12.0V	10.0V
15.0V	12.4V
16.0V	13.2V
20.0V	16.4V
22.0V	18.0V

Table 1. DCM/CCM Boundary

CCM (continuous conduction mode). As the input voltage is raised above this level the inductor has a potential for developing a dc component while the oscillator is gated on. Table 1 display the input points at which the inductor current can possibly operate in the CCM region. Operation in this region can result in a peak current slightly higher than displayed Table 4.

$$(3) \quad V_{IN(ccm)} = (V_{OUT} + V_{FWD}) + (1-D)$$

Table 2 lists common inductors suitable for most applications. Table 6 lists minimum inductor sizes versus input and output voltage. In low-cost, low-peak-current applications, RF-type leaded inductors may sufficient. All inductors listed in Table 4 can be found within the selection of CR32- or LQH4C-series inductors from either Sumida or muRata.

Manufacturer	Series	Device Type
muRata	LQH1C/3C/4C	surface mount
Sumida	CR32	surface mount
J.W. Miller	78F	axial leaded
Coilcraft	90	axial leaded

Table 2. Inductor Examples

#### Boost Output Diode

Speed, forward voltage, and reverse current are very important in selecting the output diode. In the boost configuration, the average diode current is the same as the average load current. (The peak current is the same as the peak inductor current and can be derived from Equation 2 or Figure 10.) Care must be take to make sure that the peak current is evaluated at the maximum input voltage.

Diode	75°C V <sub>FWD</sub> at 100mA	25°C V <sub>FWD</sub> at 100mA	Room Temp. Leakage at 15V	75°C Leakage at 15V	Package
MBR0530	0.275V	0.325V	2.5µA	90µA	SOD123 SMT
1N4148	0.6V (175°C)	0.95V	25nA (20V)	0.2µA (20V)	leaded and SMT
BAT54	0.4V (85°C)	0.45V	10nA (25V)	1µA (20V)	SMT
BAT85	0.54 (85°C)	0.56V	0.4µA	2µA (85°C)	DO-34 leaded

Table 3. Diode Examples

As can be seen in the "Typical Characteristics: Efficiency" graph, the output diode type can have an effect on circuit efficiency. The BAT54- and BAT85-series diodes are low-current Schottky diodes available from On Semiconductor and Phillips, respectively. They are suitable for peak repetitive currents of 300mA or less with good reverse current characteristics. For applications that are cost driven, the 1N4148, or equivalent, will provide sufficient switching speed with greater forward drop and reduced cost. Other acceptable diodes are On Semiconductor's MBR0530 or Vishay's B0530, although they can have reverse currents that exceed 1mA at very high junction temperatures. Table 3 summarizes some typical performance characteristics of various suitable diodes.

**Output Capacitor**

If the availability of tantalum capacitors is limited, ceramic capacitors and inexpensive electrolytics may be necessary. Selection of the capacitor value will depend upon on the peak inductor current and inductor size. MuRata offers the GRM series with up to 10µF at 25V, with a Y5V temperature coefficient, in a 1210 surface-mount package. Low-cost applications can use M-series leaded electrolytic capacitors from Panasonic. In general, ceramic, electrolytic, or tantalum values ranging from 10µF to 47µF can be used for the output capacitor.

Manufacturer	Series	Type	Package
muRata	GRM	ceramic Y5V	surface mount
Vishay	594	tantalum	surface mount
Panasonic	M-series	electrolytic	leaded

**Table 4. Capacitor Examples**

**Design Example**

Given a design requirement of 12V output and 1mA load with a minimum input voltage of 2.5V, Equation 1 can be used to calculate to maximum inductance or it can be read from the graph in Figure 4. Once the maximum inductance has been determined, the peak current can be determined using Equation 2 or Figure 10.

$$V_{OUT} = 12V$$

$$I_{OUT} = 1mA$$

$$V_{IN} = 4.8V \text{ to } 2.5V$$

$$L_{MAX} = \frac{V_{IN(min)}^2 \cdot t_{ON(min)}^2}{I_{O(max)} \frac{V_O}{eff} - V_{IN(min)} \cdot 2 \cdot T_{S(min)}}$$

$$L_{MAX} = 17\mu H$$

Select 15µH ±10%.

$$I_{PEAK} = \frac{t_{ON(max)} \cdot V_{IN(max)}}{L_{MIN}} = 0.767\mu s \frac{4.8V}{13.5\mu H}$$

$$I_{PEAK} = 272mA$$

Select a BAT54 diode and CR32 inductor.

Always check the peak current to insure that it is within the limits specified in the load line shown in Figure 10 for all input and output voltages.

**Gain Boost**

Use Figure 2 to increase the voltage gain of the system. The typical gain can easily be increased from the nominal gain of 6 to a value of 8 or 10. Figure 2 shows a gain of 8 so that with 2.5V applied to VC, V<sub>OUT</sub> will be 20V.

**Bootstrap**

The bootstrap configuration is used to increase the maximum output current for a given input voltage. This is most effective when the input voltage is less than 5V. Output current can typically be tripled by using this technique. See Table 4a. for bootstrap-ready-built component values.

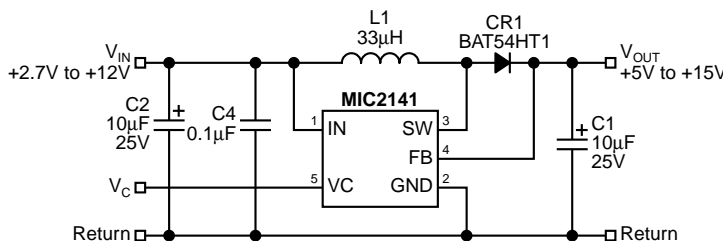

**Figure 1. Basic Configuration**

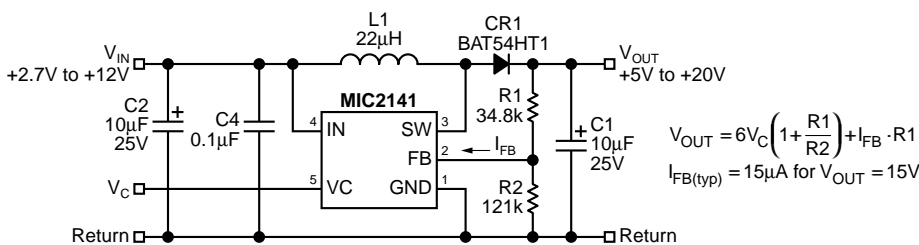

**Figure 2. Gain-Boost Configuration**

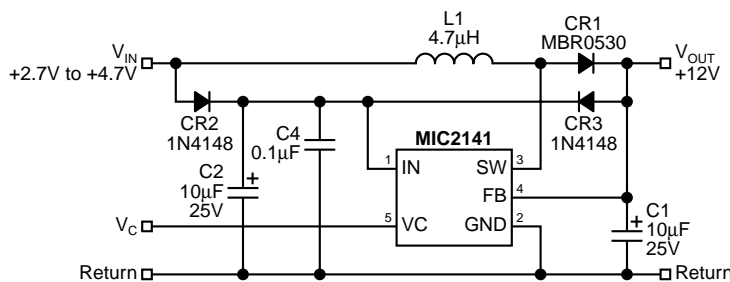

**Figure 3. Bootstrap Configuration**



Inductor Selection Guides

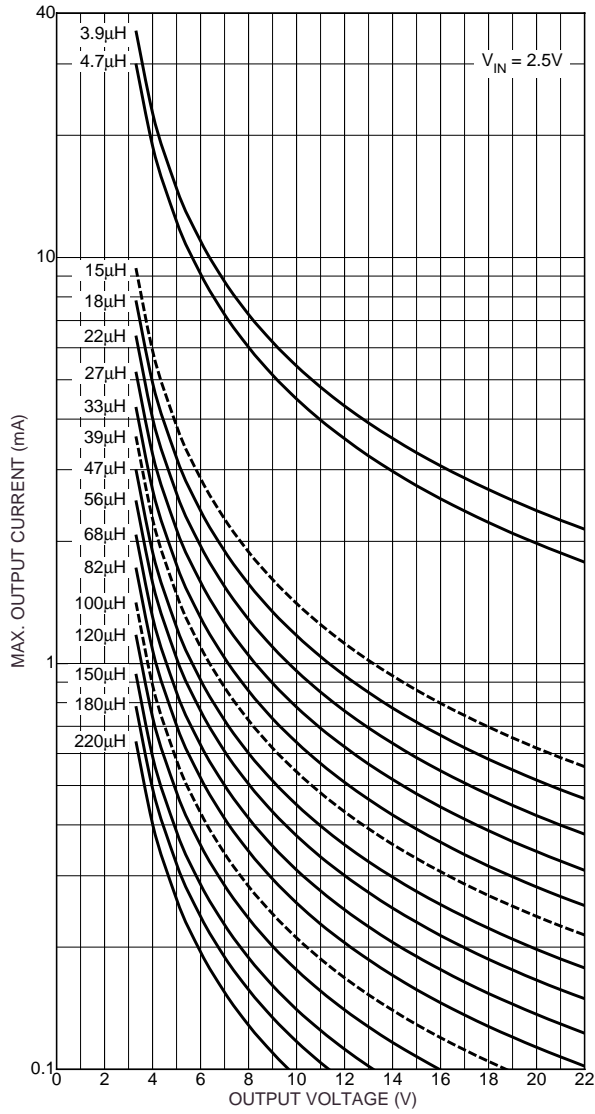

Figure 5. Inductor Selection for  $V_{IN} = 2.5V$

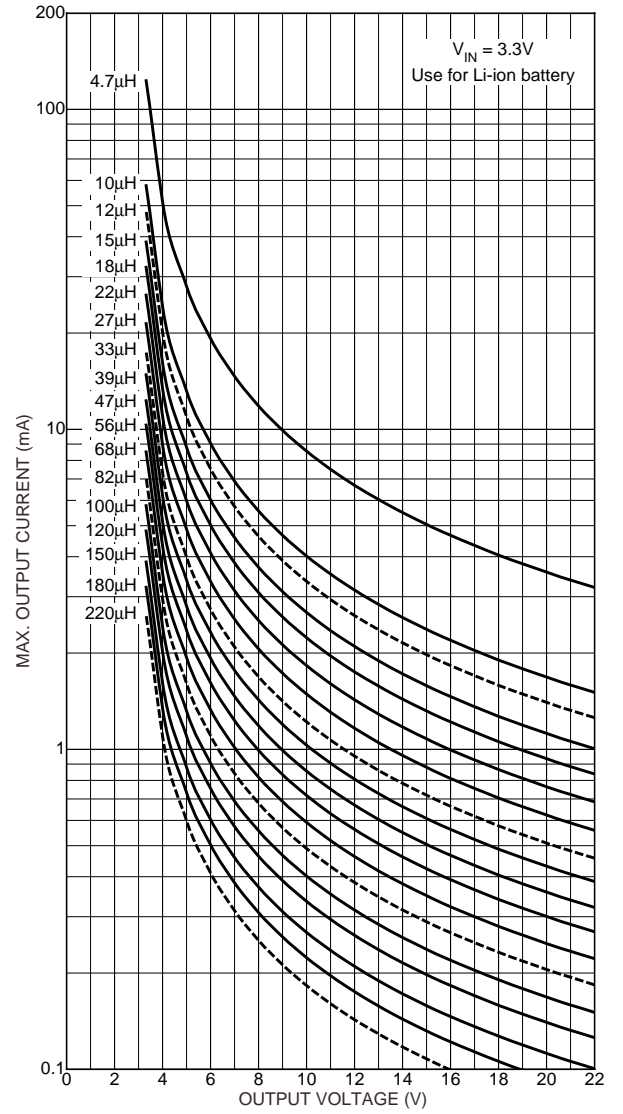

Figure 6. Inductor Selection for  $V_{IN} = 3.3V$

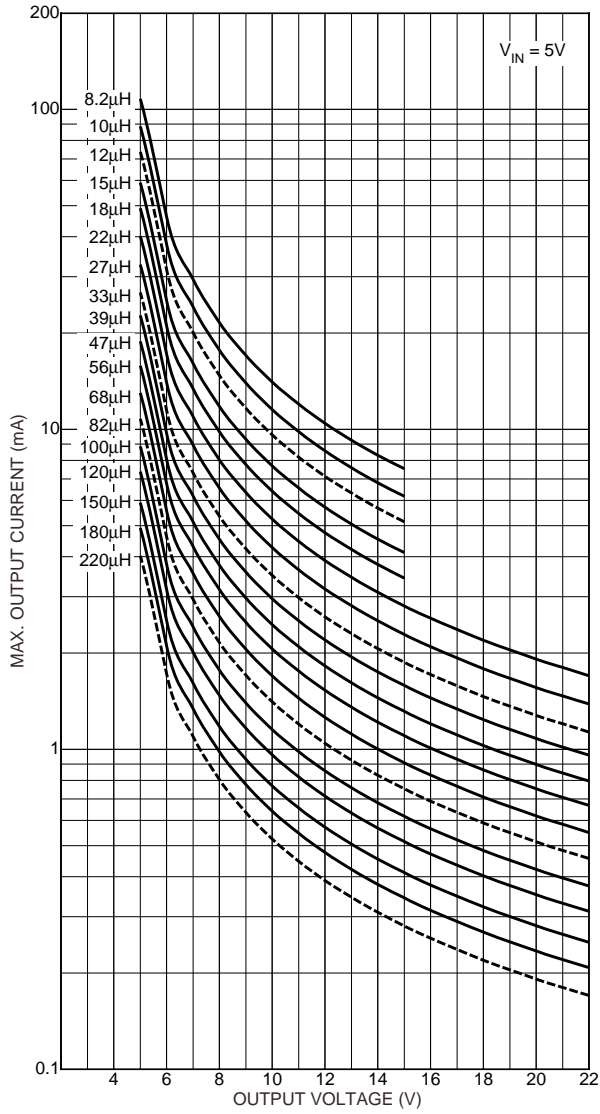

Figure7. Inductor Selection for  $V_{IN} = 5V$

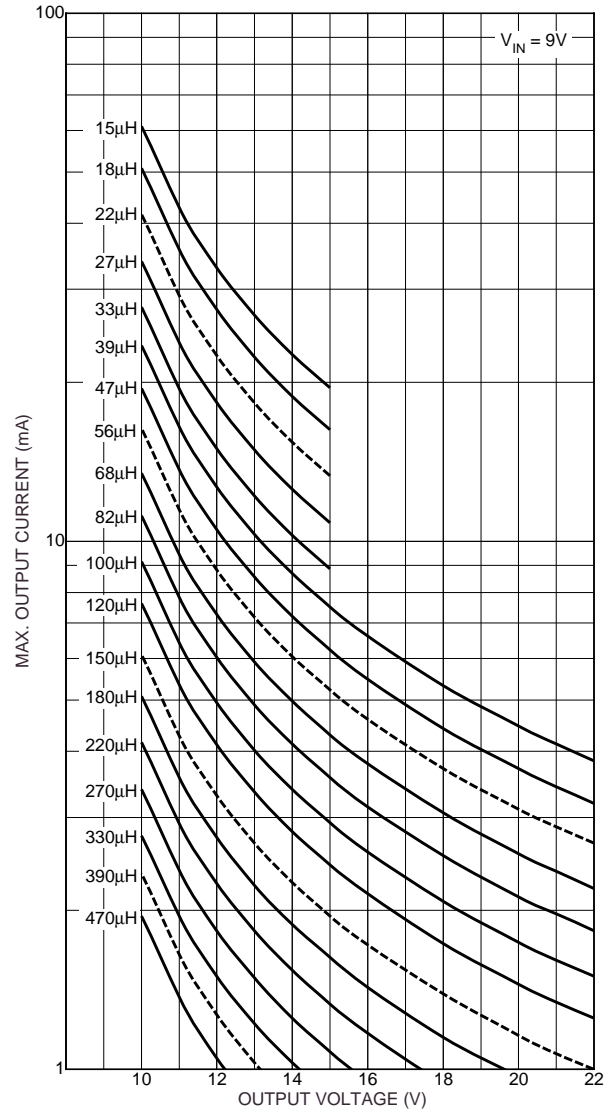

Figure 8. Inductor Selection for  $V_{IN} = 9V$

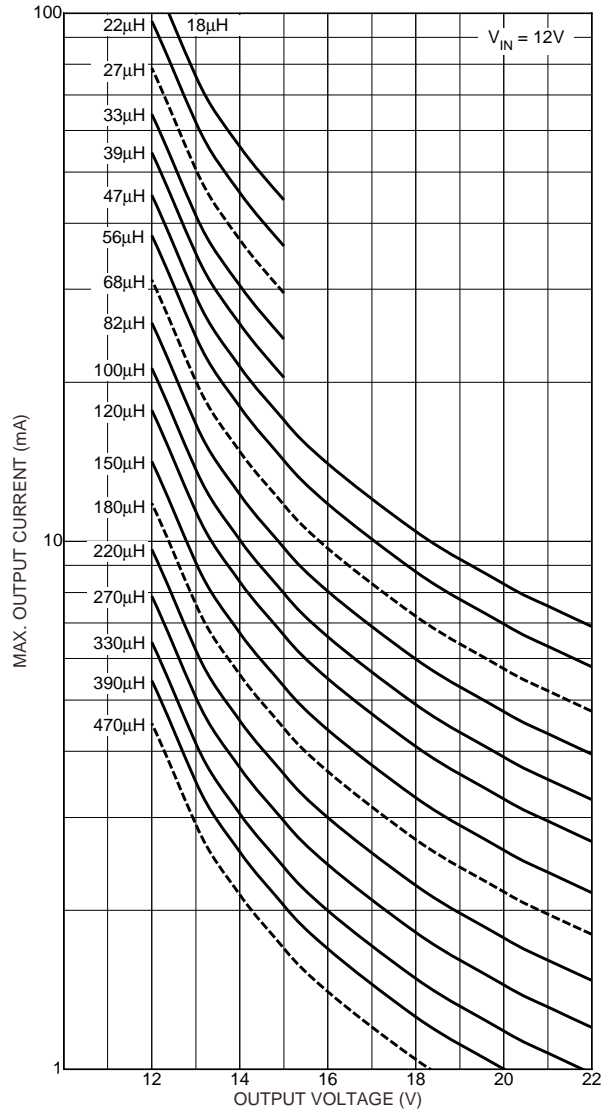

Figure 9. Inductor Selection for  $V_{IN} = 12V$

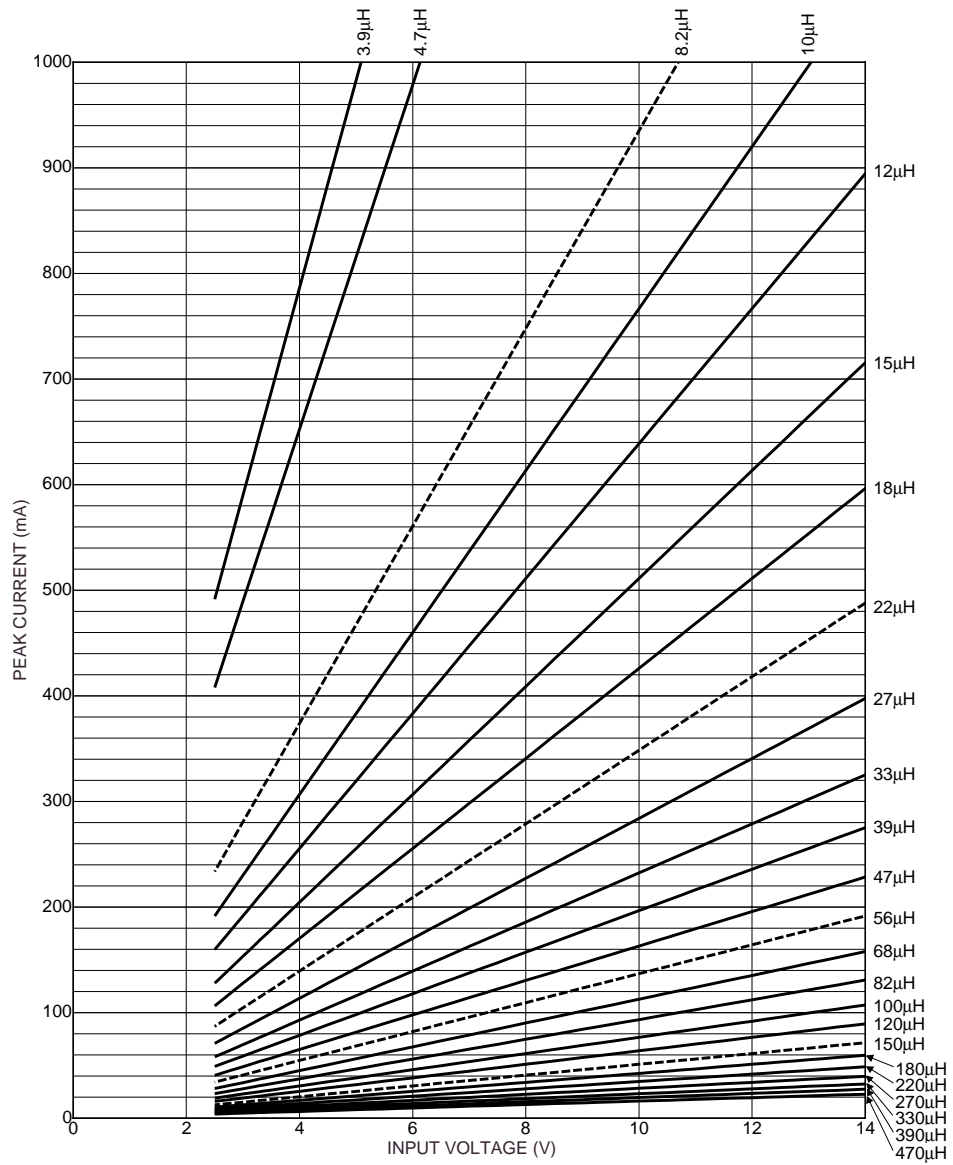

Figure 10. Peak Inductor Current vs. Input Voltage

## Predesigned Circuit Values

$V_{IN(min)}$	$V_{IN(max)}$	$V_{OUT}$	$I_{OUT(max)}$	L1	CR1	$I_{PEAK}$ ( $V_{IN} = V_{OUT} - 0.5V$ ) or 14V	$I_{PEAK}$ ( $V_{IN} = V_{IN(min)}$ )
2.5V	4.5V	5.0V	4mA	15 $\mu$ H	BAT54	230mA	128mA
			3mA	18 $\mu$ H	BAT54	192mA	106mA
			2mA	27 $\mu$ H	BAT54	128mA	71mA
			1mA	56 $\mu$ H	BAT54	62mA	34mA
			0.5mA	120 $\mu$ H	BAT54	29mA	16mA
5V bootstrap			14.8mA	3.9 $\mu$ H	MBR0503	890mA	500mA
2.5V	11.5V	12V	1mA	15 $\mu$ H	MBR0530	588mA	128mA
			0.5mA	33 $\mu$ H	BAT54	267mA	58mA
			0.2mA	82 $\mu$ H	BAT54	108mA	23mA
2.5V	4.7V	12V bootstrap	3.5mA	4.7 $\mu$ H	MBR0503	750mA	500mA
		12V bootstrap	4.3mA	3.9 $\mu$ H	MBR0503	900mA	500mA
2.5V	14V	15V	0.8mA	15 $\mu$ H	MBR0530	741mA	128mA
			0.5mA	27 $\mu$ H	MBR0530	412mA	71mA
			0.2mA	68 $\mu$ H	BAT54	163mA	28mA
2.5V	14V	16V	0.8mA	15 $\mu$ H	MBR0530	710mA	128mA
			0.5mA	22 $\mu$ H	MBR0530	456mA	87mA
			0.2mA	56 $\mu$ H	BAT54	190mA	34mA
2.5V	14V	22V	0.5mA	15 $\mu$ H	MBR0530	590mA	128mA
			0.2mA	39 $\mu$ H	BAT54	274mA	49mA
			0.1mA	82 $\mu$ H	BAT54	130mA	23mA
3.0V <i>use for Li-ion battery range</i>	4.5V	5V	10mA	12 $\mu$ H	BAT54	288mA	190mA
			3.6mA	27 $\mu$ H	BAT54	128mA	85mA
			0.8mA	120 $\mu$ H	BAT54	29mA	19mA
5V bootstrap			20mA	4.7 $\mu$ H	MBR0530	730mA	450mA
3.0V <i>use for Li-ion battery range</i>	8.5V	9V	3mA	12 $\mu$ H	MBR0530	652mA	190mA
			1.7mA	22 $\mu$ H	MBR0530	296mA	103mA
			0.8mA	47 $\mu$ H	MBR0530	139mA	49mA
3.0V <i>use for Li-ion battery range</i>	4.7V	9V bootstrap	8mA	4.7 $\mu$ H	MBR0503	750mA	450mA
3.0V <i>use for Li-ion battery range</i>	11.5V	12V	2.1mA	12 $\mu$ H	MBR0530	882mA	190mA
			1.7mA	15 $\mu$ H	MBR0530	588mA	156mA
			1mA	27 $\mu$ H	MBR0530	327mA	85mA
			0.45mA	56 $\mu$ H	BAT54	157mA	40mA
3.0V <i>use for Li-ion battery range</i>	4.7V	12V bootstrap	5.4mA	4.7 $\mu$ H	MBR0530	750mA	450mA
3.0V <i>use for Li-ion battery range</i>	14V	15V	1.6mA	12 $\mu$ H	MBR0530	926mA	190mA
			0.87mA	22 $\mu$ H	MBR0530	505mA	103mA
			0.41mA	47 $\mu$ H	BAT54	237mA	49mA
3.0V <i>use for Li-ion battery range</i>	4.7V	15V bootstrap	4mA	4.7 $\mu$ H	MBR0530	750mA	450mA
3.0V <i>use for Li-ion battery range</i>	14V	22V	1mA	10 $\mu$ H	MBR0530	1071mA	190mA
			0.8mA	15 $\mu$ H	MBR0530	714mA	152mA
			0.46mA	27 $\mu$ H	MBR0530	400mA	85mA
			0.2mA	68 $\mu$ H	BAT54	157mA	3.3mA

Table 4a. Typical Configurations for Wide-Range Inputs—2.5V to 3.0V Minimum Input

$V_{IN(min)}$	$V_{IN(max)}$	$V_{OUT}$	$I_{OUT(max)}$	L1	CR1	$I_{PEAK}$ ( $V_{IN} = V_{OUT} - 0.5V$ )	$I_{PEAK}$ ( $V_{IN} = V_{IN(min)}$ )
5.0V	8.5V	9V	17mA	8.2 $\mu$ H	MBR0530	795mA	467mA
			15mA	10 $\mu$ H	MBR0530	652mA	383mA
			10mA	12 $\mu$ H	MBR0530	643mA	319mA
			5mA	27 $\mu$ H	BAT54	241mA	142mA
			1mA	120 $\mu$ H	BAT54	54mA	32mA
5.0V	11.5V	12V	10mA	8.2 $\mu$ H	MBR0530	1,075mA	467mA
			5mA	18 $\mu$ H	MBR0530	490mA	213mA
			2mA	39 $\mu$ H	BAT54	226mA	98mA
			1mA	82 $\mu$ H	BAT54	108mA	47mA
5.0V	14V	15V	7mA	8.2 $\mu$ H	MBR0530	1356mA	467mA
			5mA	12 $\mu$ H	MBR0530	926mA	319mA
			2mA	27 $\mu$ H	MBR0530	412mA	142mA
			1mA	56 $\mu$ H	BAT54	199mA	68mA
5.0V	14V	16V	2.5mA	22 $\mu$ H	MBR0530	986mA	174mA
			1mA	56 $\mu$ H	BAT54	190mA	68mA
			0.5mA	120 $\mu$ H	BAT54	90mA	32mA
5.0V	14V	22V	1.7mA	22 $\mu$ H	MBR0530	486mA	174mA
			1.0mA	39 $\mu$ H	BAT54	274mA	98mA
			0.5mA	82 $\mu$ H	BAT54	130mA	47mA
			0.1mA	180 $\mu$ H	BAT54	60mA	21mA
9.0V	11.5V	12V	33mA	15 $\mu$ H	MBR0530	588mA	460mA
			20mA	22 $\mu$ H	MBR0530	401mA	314mA
			10mA	47 $\mu$ H	BAT54	188mA	147mA
			5mA	100 $\mu$ H	BAT54	88mA	69mA
			1mA	470 $\mu$ H	BAT54	19mA	15mA
9.0V	14V	15V	20mA	15 $\mu$ H	MBR0530	741mA	460mA
			10mA	27 $\mu$ H	MBR0530	412mA	256mA
			5mA	56 $\mu$ H	BAT54	199mA	123mA
			2mA	150 $\mu$ H	BAT54	74mA	46mA
			1mA	270 $\mu$ H	BAT54	41mA	26mA
9.0V	14V	20V	4.5mA	39 $\mu$ H	BAT54	215mA	177mA
			2mA	68 $\mu$ H	BAT54	131mA	84mA
			1mA	150 $\mu$ H	BAT54	72mA	46mA
9.0V	14V	22V	4mA	39 $\mu$ H	BAT54	275mA	177mA
			2mA	68 $\mu$ H	BAT54	157mA	101mA
			1mA	150 $\mu$ H	BAT54	72mA	46mA
12V	14V	15V	45mA	18 $\mu$ H	MBR0530	618mA	511mA
			20mA	39 $\mu$ H	BAT54	285mA	236mA
			10mA	82 $\mu$ H	BAT54	136mA	112mA
			5mA	150 $\mu$ H	BAT54	74mA	61mA
			1.7mA	470 $\mu$ H	BAT54	24mA	20mA
12V	14V	20V	8mA	47 $\mu$ H	BAT54	230mA	196mA
			5mA	68 $\mu$ H	BAT54	158mA	135mA
			2mA	120 $\mu$ H	BAT54	90mA	77mA
			1mA	390 $\mu$ H	BAT54	27mA	24mA
12V	21.5V	22V	7mA	47 $\mu$ H	BAT54	228mA	196mA
			5mA	68 $\mu$ H	BAT54	157mA	135mA
			2mA	150 $\mu$ H	BAT54	69mA	61mA
			1mA	220 $\mu$ H	BAT54	47mA	42mA

Table 4b. Typical Configurations for Wide-Range Inputs—5V to 15V Minimum Input

$V_{IN}$	$V_{OUT}$	$I_{OUT}$	L1	CR1	$I_{PEAK}$ (typical)
3.3V $\pm$ 5%	5V	13mA	10 $\mu$ H	BAT54	253mA
	9V	5mA	10 $\mu$ H	BAT54	253mA
	12V	3mA	10 $\mu$ H	BAT54	253mA
	15V	2.3mA	10 $\mu$ H	BAT54	253mA
	20V	1.7mA	10 $\mu$ H	BAT54	253mA
5V $\pm$ 5%	9V	17mA	8.2 $\mu$ H	MB0530	467mA
	12V	10.4mA	8.2 $\mu$ H	MB0530	467mA
	15V	7.5mA	8.2 $\mu$ H	MB0530	467mA
	20V	2.2mA	22 $\mu$ H	MB0530	174mA
12V $\pm$ 5%	15V	44mA	18 $\mu$ H	MB0530	511mA
	20V	8.3mA	47 $\mu$ H	BAT54	196mA

**Table 5. Typical Maximum Power Configuration for Regulated Inputs**

$V_{IN}$	Output Voltage	
	16V to 22V	4.5V to 15V
2.5V	15 $\mu$ H	15 $\mu$ H
3.0V	12 $\mu$ H	12 $\mu$ H
3.3V	10 $\mu$ H	10 $\mu$ H
3.5V	8.2 $\mu$ H	8.2 $\mu$ H
4.0V	27 $\mu$ H	6.8 $\mu$ H
4.5V	27 $\mu$ H	6.8 $\mu$ H
5.0V	22 $\mu$ H	8.2 $\mu$ H
6.0V	27 $\mu$ H	10 $\mu$ H
7.0V	27 $\mu$ H	10 $\mu$ H
8.0V	33 $\mu$ H	12 $\mu$ H
9.0V	39 $\mu$ H	15 $\mu$ H
10V	39 $\mu$ H	15 $\mu$ H
11V	47 $\mu$ H	18 $\mu$ H
12V	47 $\mu$ H	18 $\mu$ H
13V	56 $\mu$ H	22 $\mu$ H
14V	56 $\mu$ H	22 $\mu$ H
15V	56 $\mu$ H	27 $\mu$ H
16V	68 $\mu$ H	27 $\mu$ H

**Table 6. Minimum Inductance**

Manufacturer	Web Address
muRata	<a href="http://www.MuRata.com">www.MuRata.com</a>
Sumida	<a href="http://www.sumida.com">www.sumida.com</a>
Coilcraft	<a href="http://www.coilcraft.com">www.coilcraft.com</a>
J. W. Miller	<a href="http://www.jwmiller.com">www.jwmiller.com</a>
Micrel	<a href="http://www.micrel.com">www.micrel.com</a>
Vishay	<a href="http://www.vishay.com">www.vishay.com</a>
Panasonic	<a href="http://www.panasonic.com">www.panasonic.com</a>

**Table 7. Component Supplier Websites**

**Package Information**

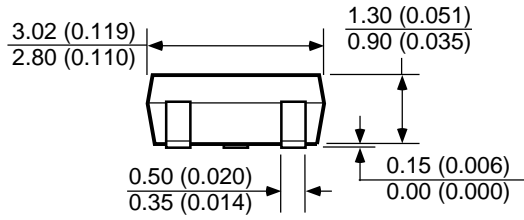
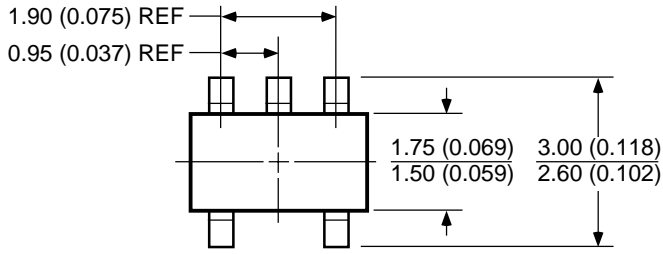

DIMENSIONS:  
MM (INCH)

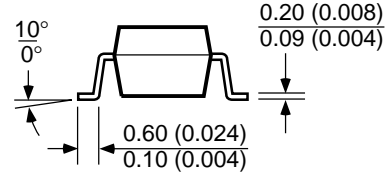

**SOT-23-5 (M)**

**MICREL INC. 1849 FORTUNE DRIVE SAN JOSE, CA 95131 USA**

TEL + 1 (408) 944-0800 FAX + 1 (408) 944-0970 WEB <http://www.micrel.com>

This information is believed to be accurate and reliable, however no responsibility is assumed by Micrel for its use nor for any infringement of patents or other rights of third parties resulting from its use. No license is granted by implication or otherwise under any patent or patent right of Micrel Inc.

© 2000 Micrel Incorporated