



+5V, Low-Power, 12-Bit Serial ADCs

MAX187/MAX189

General Description

The MAX187/MAX189 serial 12-bit analog-to-digital converters (ADCs) operate from a single +5V supply and accept a 0V to 5V analog input. Both parts feature an 8.5µs successive-approximation ADC, a fast track/hold (1.5µs), an on-chip clock, and a high-speed 3-wire serial interface.

The MAX187/MAX189 digitize signals at a 75ksp/s throughput rate. An external clock accesses data from the interface, which communicates without external hardware to most digital signal processors and micro-controllers. The interface is compatible with SPI™, QSPI™, and Microwire™.

The MAX187 has an on-chip buffered reference, and the MAX189 requires an external reference. Both the MAX187 and MAX189 save space with 8-pin DIP and 16-pin SO packages. Power consumption is 7.5mW and reduces to only 10µW in shutdown.

Excellent AC characteristics and very low power consumption combined with ease of use and small package size make these converters ideal for remote DSP and sensor applications, or for circuits where power consumption and space are crucial.

Applications

- Portable Data Logging
- Remote Digital Signal Processing
- Isolated Data Acquisition
- High-Accuracy Process Control

Functional Diagram

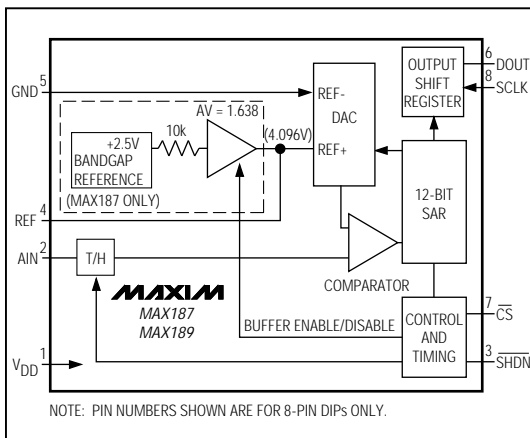

Features

- ◆ 12-Bit Resolution
- ◆ ±½ LSB Integral Nonlinearity (MAX187A/MAX189A)
- ◆ Internal Track/Hold, 75kHz Sampling Rate
- ◆ Single +5V Operation
- ◆ Low Power: 2µA Shutdown Current
1.5mA Operating Current
- ◆ Internal 4.096V Buffered Reference (MAX187)
- ◆ 3-Wire Serial Interface, Compatible with SPI, QSPI, and Microwire
- ◆ Small-Footprint 8-Pin DIP and 16-Pin SO

Ordering Information

| PART | TEMP. RANGE | PIN-PACKAGE | ERROR (LSB) |
|------------|--------------|---------------|-------------|
| MAX187ACPA | 0°C to +70°C | 8 Plastic DIP | ±½ |
| MAX187BCPA | 0°C to +70°C | 8 Plastic DIP | ±1 |
| MAX187CCPA | 0°C to +70°C | 8 Plastic DIP | ±2 |
| MAX187ACWE | 0°C to +70°C | 16 Wide SO | ±½ |
| MAX187BCWE | 0°C to +70°C | 16 Wide SO | ±1 |
| MAX187CCWE | 0°C to +70°C | 16 Wide SO | ±2 |
| MAX187BC/D | 0°C to +70°C | Dice* | ±1 |

Ordering Information continued on last page.

* Dice are specified at TA = +25°C, DC parameters only.
** Contact factory for availability and processing to MIL-STD-883.

Pin Configurations

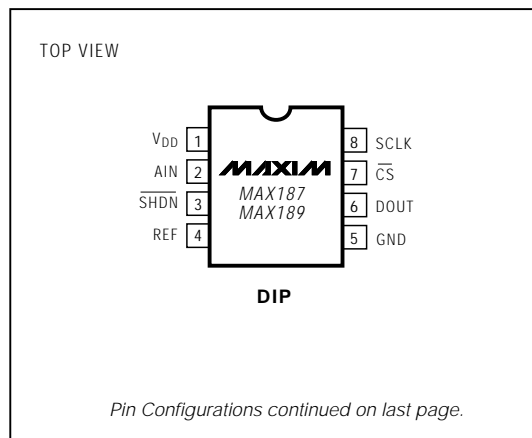

™ SPI and QSPI are trademarks of Motorola. Microwire is a trademark of National Semiconductor.



+5V, Low-Power, 12-Bit Serial ADCs

ABSOLUTE MAXIMUM RATINGS

| | | |
|-------------------------------------|-----------------------------------|---|
| V _{DD} to GND | -0.3V to +6V | Continuous Power Dissipation (T _A = +70°C) |
| AIN to GND | -0.3V to (V _{DD} + 0.3V) | 8-Pin Plastic DIP (derate 9.09mW/°C above +70°C) ...500mW |
| REF to GND | -0.3V to (V _{DD} + 0.3V) | 16-Pin Wide SO (derate 8.70mW/°C above +70°C) ...478mW |
| Digital Inputs to GND | -0.3V to (V _{DD} + 0.3V) | 8-Pin CERDIP (derate 8.00mW/°C above +70°C)440mW |
| Digital Outputs to GND | -0.3V to (V _{DD} + 0.3V) | Operating Temperature Ranges: |
| SHDN to GND | -0.3V to (V _{DD} + 0.3V) | MAX187_C_/MAX189_C_0°C to +70°C |
| REF Load Current (MAX187) | 4.0mA Continuous | MAX187_E_/MAX189_E_-40°C to +85°C |
| REF Short-Circuit Duration (MAX187) | 20sec | MAX187_MJA/MAX189_MJA-55°C to +125°C |
| DOUT Current | ±20mA | Storage Temperature Range-60°C to +150°C |
| | | Lead Temperature (soldering, 10sec)+300°C |

Stresses beyond those listed under "Absolute Maximum Ratings" may cause permanent damage to the device. These are stress ratings only, and functional operation of the device at these or any other conditions beyond those indicated in the operational sections of the specifications is not implied. Exposure to absolute maximum rating conditions for extended periods may affect device reliability.

ELECTRICAL CHARACTERISTICS

(V_{DD} = +5V ±5%; GND = 0V; unipolar input mode; 75ksps, f_{CLK} = 4.0MHz, external clock (50% duty cycle); MAX187—internal reference: V_{REF} = 4.096V, 4.7μF capacitor at REF pin, or MAX189—external reference: V_{REF} = 4.096V applied to REF pin, 4.7μF capacitor at REF pin; T_A = T_{MIN} to T_{MAX}; unless otherwise noted.)

| PARAMETER | SYMBOL | CONDITIONS | MIN | TYP | MAX | UNITS |
|---|--------|-----------------------------------|-----|-----|--------|--------|
| DC ACCURACY (Note 1) | | | | | | |
| Resolution | | | | | 12 | Bits |
| Relative Accuracy (Note 2) | | MAX18_A | | | ±1/2 | LSB |
| | | MAX18_B | | | ±1 | |
| | | MAX18_C | | | ±2 | |
| Differential Nonlinearity | DNL | No missing codes over temperature | | | ±1 | LSB |
| Offset Error | | MAX18_A | | | ±1 1/2 | LSB |
| | | MAX18_B/C | | | ±3 | |
| Gain Error (Note 3) | | MAX187 | | | ±3 | LSB |
| | | MAX189A | | | ±1 | |
| | | MAX189B/C | | | ±3 | |
| Gain Temperature Coefficient | | External reference, 4.096V | | | ±0.8 | ppm/°C |
| DYNAMIC SPECIFICATIONS (10kHz sine wave input, 0V to 4.096V _{p-p} , 75ksps) | | | | | | |
| Signal-to-Noise plus Distortion Ratio | SINAD | | 70 | | | dB |
| Total Harmonic Distortion (up to the 5th harmonic) | THD | | | | -80 | dB |
| Spurious-Free Dynamic Range | SFDR | | 80 | | | dB |
| Small-Signal Bandwidth | | Rolloff -3dB | | 4.5 | | MHz |
| Full-Power Bandwidth | | | | 0.8 | | MHz |

+5V, Low-Power, 12-Bit Serial ADCs

MAX187/MAX189

ELECTRICAL CHARACTERISTICS (continued)

($V_{DD} = +5V \pm 5\%$; $GND = 0V$; unipolar input mode; 75ksps, $f_{CLK} = 4.0MHz$, external clock (50% duty cycle); MAX187—internal reference: $V_{REF} = 4.096V$, 4.7 μF capacitor at REF pin, or MAX189—external reference: $V_{REF} = 4.096V$ applied to REF pin, 4.7 μF capacitor at REF pin; $T_A = T_{MIN}$ to T_{MAX} ; unless otherwise noted.)

| PARAMETER | SYMBOL | CONDITIONS | MIN | TYP | MAX | UNITS | |
|---|------------|---------------------------------|----------|----------|-----------------|-----------------|---|
| CONVERSION RATE | | | | | | | |
| Conversion Time | t_{CONV} | | 5.5 | | 8.5 | μs | |
| Track/Hold Acquisition Time | t_{ACO} | | 1.5 | | | μs | |
| Throughput Rate | | External clock, 4MHz, 13 clocks | | | 75 | ksps | |
| Aperture Delay | t_{APR} | | | 10 | | ns | |
| Aperture Jitter | | | | <50 | | ps | |
| ANALOG INPUT | | | | | | | |
| Input Voltage Range | | | | | 0 to V_{REF} | V | |
| Input Capacitance (Note 4) | | | | 16 | | pF | |
| INTERNAL REFERENCE (MAX187 only, reference buffer enabled) | | | | | | | |
| REF Output Voltage | V_{REF} | $T_A = +25^\circ C$ | | 4.076 | 4.096 | 4.116 | V |
| | | $T_A = T_{MIN}$ to T_{MAX} | MAX187_C | 4.060 | | 4.132 | |
| | | | MAX187_E | 4.050 | | 4.140 | |
| | | | MAX187_M | 4.040 | | 4.150 | |
| REF Short-Circuit Current | | | | 30 | | mA | |
| REF Tempco | | MAX187AC/BC | | ± 30 | ± 50 | ppm/ $^\circ C$ | |
| | | MAX187AE/BE | | ± 30 | ± 60 | | |
| | | MAX187AM/BM | | ± 30 | ± 80 | | |
| | | MAX187C | | ± 30 | | | |
| Load Regulation (Note 5) | | 0mA to 0.6mA output load | | 1 | | mV | |
| EXTERNAL REFERENCE AT REF (Buffer disabled, $V_{REF} = 4.096V$) | | | | | | | |
| Input Voltage Range | | | 2.50 | | $V_{DD} + 50mV$ | V | |
| Input Current | | | | 200 | 350 | μA | |
| Input Resistance | | | 12 | 20 | | k Ω | |
| Shutdown REF Input Current | | | | 1.5 | 10 | μA | |

+5V, Low-Power, 12-Bit Serial ADCs

MAX187/MAX189

ELECTRICAL CHARACTERISTICS (continued)

($V_{DD} = +5V \pm 5\%$; $GND = 0V$; unipolar input mode; 75ksps, $f_{CLK} = 4.0MHz$, external clock (50% duty cycle); MAX187—internal reference: $V_{REF} = 4.096V$, 4.7 μF capacitor at REF pin, or MAX189—external reference: $V_{REF} = 4.096V$ applied to REF pin, 4.7 μF capacitor at REF pin; $T_A = T_{MIN}$ to T_{MAX} ; unless otherwise noted.)

| PARAMETER | SYMBOL | CONDITIONS | MIN | TYP | MAX | UNITS |
|--|------------|---|----------------|------------|----------------|---------|
| DIGITAL INPUTS (SCLK, \overline{CS}, SHDN) | | | | | | |
| SCLK, \overline{CS} Input High Voltage | V_{INH} | | 2.4 | | | V |
| SCLK, \overline{CS} Input Low Voltage | V_{INL} | | | | 0.8 | V |
| SCLK, \overline{CS} Input Hysteresis | V_{HYST} | | | 0.15 | | V |
| SCLK, \overline{CS} Input Leakage | I_{IN} | $V_{IN} = 0V$ or V_{DD} | | | ± 1 | μA |
| SCLK, \overline{CS} Input Capacitance | C_{IN} | (Note 4) | | | 15 | pF |
| SHDN Input High Voltage | V_{INSH} | | $V_{DD} - 0.5$ | | | V |
| SHDN Input Low Voltage | V_{INSL} | | | | 0.5 | V |
| SHDN Input Current | I_{INS} | SHDN = V_{DD} or 0V | | | ± 4.0 | μA |
| SHDN Input Mid Voltage | V_{IM} | | 1.5 | | $V_{DD} - 1.5$ | V |
| SHDN Voltage, Floating | V_{FLT} | SHDN = open | | 2.75 | | V |
| SHDN Maximum Allowed Leakage, Mid Input | | SHDN = open | -100 | | 100 | nA |
| DIGITAL OUTPUT (DOUT) | | | | | | |
| Output Voltage Low | V_{OL} | $I_{SINK} = 5mA$ | | | 0.4 | V |
| | | $I_{SINK} = 16mA$ | | | 0.3 | |
| Output Voltage High | V_{OH} | $I_{SOURCE} = 1mA$ | 4 | | | V |
| Three-State Leakage Current | I_L | $\overline{CS} = 5V$ | | | ± 10 | μA |
| Three-State Output Capacitance | C_{OUT} | $\overline{CS} = 5V$ (Note 4) | | | 15 | pF |
| POWER REQUIREMENTS | | | | | | |
| Supply Voltage | V_{DD} | | 4.75 | | 5.25 | V |
| Supply Current | I_{DD} | Operating mode | MAX187 | 1.5 | 2.5 | mA |
| | | | MAX189 | 1.0 | 2.0 | |
| | | Power-down mode | | 2 | 10 | μA |
| Power-Supply Rejection | PSR | $V_{DD} = +5V, \pm 5\%$; external reference, 4.096V; full-scale input (Note 6) | | ± 0.06 | ± 0.5 | mV |

+5V, Low-Power, 12-Bit Serial ADCs

MAX187/MAX189

TIMING CHARACTERISTICS

($V_{DD} = +5.0V \pm 5\%$, $T_A = T_{MIN}$ to T_{MAX} , unless otherwise noted.)

| PARAMETER | SYMBOL | CONDITIONS | MIN | TYP | MAX | UNITS |
|--------------------------------|------------|--------------------|-------------|-----|-----|---------|
| Track/Hold Acquisition Time | t_{ACQ} | CS = high (Note 7) | 1.5 | | | μs |
| SCLK Fall to Output Data Valid | t_{DO} | $C_{LOAD} = 100pF$ | MAX18_ _C/E | 20 | 150 | ns |
| | | | MAX18_ _M | 20 | 200 | |
| CS Fall to Output Enable | t_{DV} | $C_{LOAD} = 100pF$ | | | 100 | ns |
| CS Rise to Output Disable | t_{TR} | $C_{LOAD} = 100pF$ | | | 100 | ns |
| SCLK Clock Frequency | f_{SCLK} | | | | 5 | MHz |
| SCLK Pulse Width High | t_{CH} | | 100 | | | ns |
| SCLK Pulse Width Low | t_{CL} | | 100 | | | ns |
| SCLK Low to CS Fall Setup Time | t_{CSO} | | 50 | | | ns |
| CS Pulse Width | t_{CS} | | 500 | | | ns |

Note 1: Tested at $V_{DD} = +5V$.

Note 2: Relative accuracy is the deviation of the analog value at any code from its theoretical value after the full-scale range has been calibrated.

Note 3: MAX187—internal reference, offset nulled; MAX189—external +4.096V reference, offset nulled. Excludes reference errors.

Note 4: Guaranteed by design. Not subject to production testing.

Note 5: External load should not change during conversion for specified ADC accuracy.

Note 6: DC test, measured at 4.75V and 5.25V only.

Note 7: To guarantee acquisition time, t_{ACQ} is the maximum time the device takes to acquire the signal, and is also the minimum time needed for the signal to be acquired.

+5V, Low-Power, 12-Bit Serial ADCs

Typical Operating Characteristics

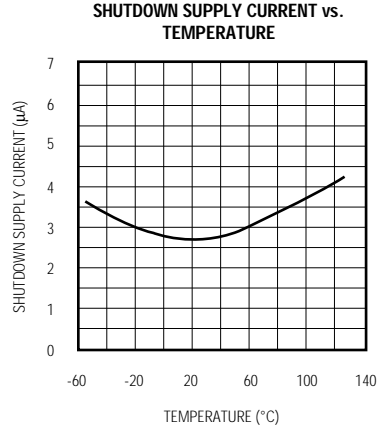
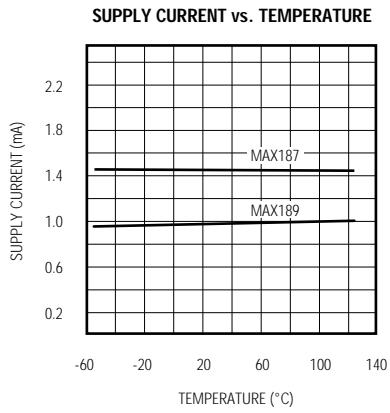
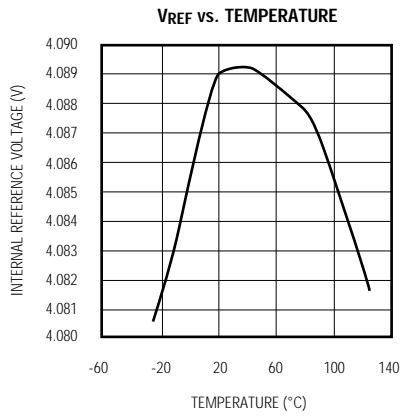
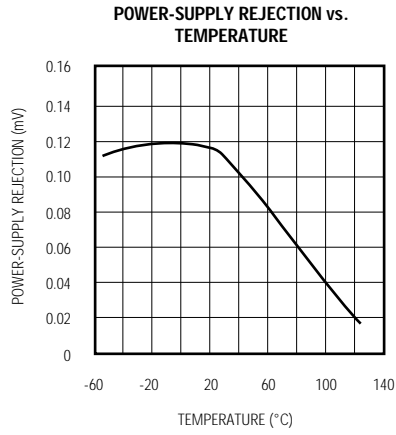

+5V, Low-Power, 12-Bit Serial ADCs

Pin Description

MAX187/MAX189

| PIN | | NAME | FUNCTION |
|-----|-----------------|--------------------------|---|
| DIP | WIDE SO | | |
| 1 | 1 | V _{DD} | Supply voltage, +5V ±5% |
| 2 | 3 | AIN | Sampling analog input, 0V to V _{REF} range |
| 3 | 6 | $\overline{\text{SHDN}}$ | Three-level shutdown input. Pulling $\overline{\text{SHDN}}$ low shuts the MAX187/MAX189 down to 10µA (max) supply current. Both MAX187 and MAX189 are fully operational with either $\overline{\text{SHDN}}$ high or floating. For the MAX187, pulling $\overline{\text{SHDN}}$ high enables the internal reference, and letting $\overline{\text{SHDN}}$ float disables the internal reference and allows for the use of an external reference. |
| 4 | 8 | REF | Reference voltage—sets analog voltage range and functions as a 4.096V output for the MAX187 with enabled internal reference. REF also serves as a +2.5V to V _{DD} input for a precision reference for both MAX187 (disabled internal reference) and MAX189. Bypass with 4.7µF if internal reference is used, and with 0.1µF if an external reference is applied. |
| 5 | — | GND | Analog and digital ground |
| — | 10 | AGND | Analog ground |
| — | 11 | DGND | Digital ground |
| 6 | 12 | DOUT | Serial data output. Data changes state at SCLK's falling edge. |
| 7 | 15 | $\overline{\text{CS}}$ | Active-low chip select initiates conversions on the falling edge. When $\overline{\text{CS}}$ is high, DOUT is high impedance. |
| 8 | 16 | SCLK | Serial clock input. Clocks data out with rates up to 5MHz. |
| — | 2,4,5,7,9,13,14 | N.C. | Not internally connected. Connect to AGND for best noise performance. |

Detailed Description

Converter Operation

The MAX187/MAX189 use input track/hold (T/H) and successive approximation register (SAR) circuitry to convert an analog input signal to a digital 12-bit output. No external hold capacitor is needed for the T/H. Figures 3a and 3b show the MAX187/MAX189 in their simplest configuration. The MAX187/MAX189 convert input signals in the 0V to V_{REF} range in 10µs, including T/H acquisition time. The MAX187's internal reference is trimmed to 4.096V, while the MAX189 requires an external reference. Both devices accept external reference voltages from +2.5V to V_{DD}. The serial interface requires only three digital lines, SCLK, $\overline{\text{CS}}$, and DOUT, and provides easy interface to microprocessors (µPs).

Both converters have two modes: normal and shutdown. Pulling $\overline{\text{SHDN}}$ low shuts the device down and reduces supply current to below 10µA, while pulling $\overline{\text{SHDN}}$ high or leaving it floating puts the device into the operational mode. A conversion is initiated by $\overline{\text{CS}}$ falling. The conversion result is available at DOUT in

unipolar serial format. A high bit, signaling the end of conversion (EOC), followed by the data bits (MSB first), make up the serial data stream.

The MAX187 operates in one of two states: (1) internal reference and (2) external reference. Select internal reference operation by forcing $\overline{\text{SHDN}}$ high, and external reference operation by floating $\overline{\text{SHDN}}$.

Analog Input

Figure 4 illustrates the sampling architecture of the ADC's analog comparator. The full-scale input voltage depends on the voltage at REF.

| REFERENCE | ZERO SCALE | FULL SCALE |
|----------------------------------|------------|------------------|
| Internal Reference (MAX187 only) | 0V | +4.096V |
| External Reference | 0V | V _{REF} |

For specified accuracy, the external reference voltage range spans from +2.5V to V_{DD}.

+5V, Low-Power, 12-Bit Serial ADCs

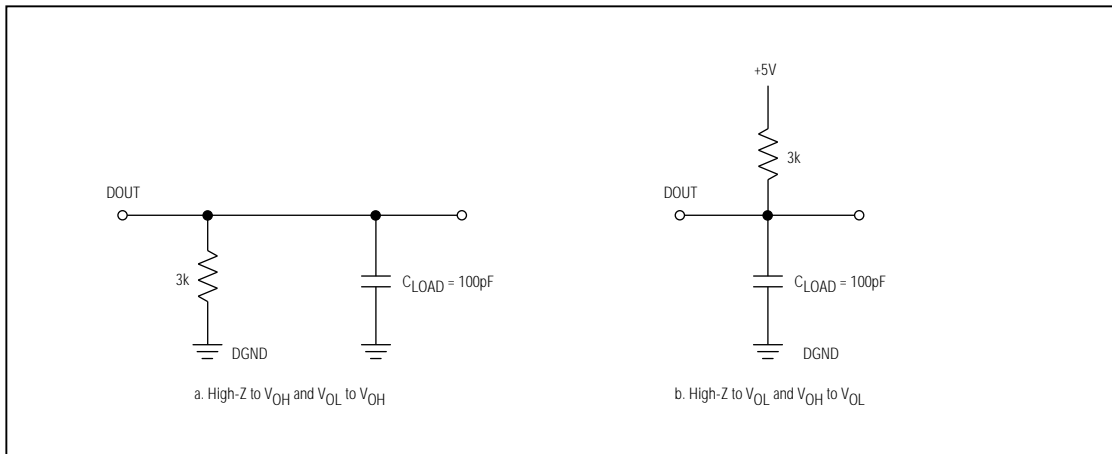

Figure 1. Load Circuits for DOUT Enable Time

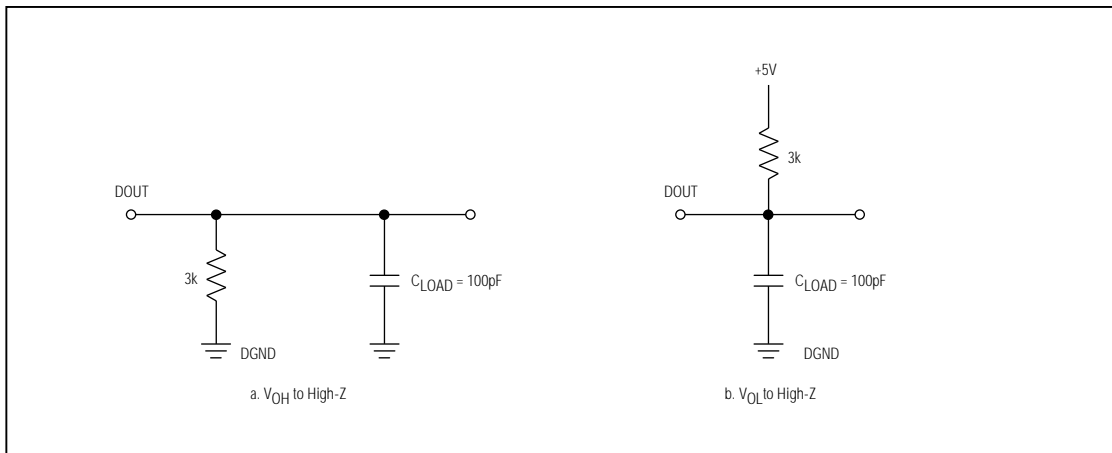

Figure 2. Load Circuits for DOUT Disable Time

+5V, Low-Power, 12-Bit Serial ADCs

Input Bandwidth

The ADCs' input tracking circuitry has a 4.5MHz small-signal bandwidth, and an 8V/ μ s slew rate. It is possible to digitize high-speed transient events and measure periodic signals with bandwidths exceeding the ADC's sampling rate by using undersampling techniques. To avoid aliasing of unwanted high-frequency signals into the frequency band of interest, an anti-alias filter is recommended. See the MAX274/MAX275 continuous-time filters data sheet.

Input Protection

Internal protection diodes that clamp the analog input allow the input to swing from GND - 0.3V to $V_{DD} + 0.3V$ without damage. However, for accurate conversions near full scale, the input must not exceed V_{DD} by more than 50mV, or be lower than GND by 50mV.

If the analog input exceeds the supplies by more than 50mV beyond the supplies, limit the input current to 2mA, since larger currents degrade conversion accuracy.

Driving the Analog Input

The input lines to AIN and GND should be kept as short as possible to minimize noise pickup. Shield longer leads. Also see the *Input Protection* section.

Because the MAX187/MAX189 incorporate a T/H, the drive requirements of the op amp driving AIN are less stringent than those for a successive-approximation ADC without a T/H. The typical input capacitance is 16pF. The amplifier bandwidth should be sufficient to handle the frequency of the input signal. The MAX400 and OP07 work well at lower frequencies. For higher-frequency operation, the MAX427 and OP27 are practical choices. The allowed input frequency range is limited

by the 75ksps sample rate of the MAX187/MAX189. Therefore, the maximum sinusoidal input frequency allowed is 37.5kHz. Higher-frequency signals cause aliasing problems unless undersampling techniques are used.

Reference

The MAX187 can be used with an internal or external reference, while the MAX189 requires an external reference.

Internal Reference

The MAX187 has an on-chip reference with a buffered temperature-compensated bandgap diode, laser-trimmed to $+4.096V \pm 0.5\%$. Its output is connected to REF and also drives the internal DAC. The output can be used as a reference voltage source for other components and can source up to 0.6mA. Decouple REF with a 4.7 μ F capacitor. The internal reference is enabled by pulling the SHDN pin high. Letting SHDN float disables the internal reference, which allows the use of an external reference, as described in the *External Reference* section.

External Reference

The MAX189 operates with an external reference at the REF pin. To use the MAX187 with an external reference, disable the internal reference by letting SHDN float. Stay within the voltage range $+2.5V$ to V_{DD} to achieve specified accuracy. The minimum input impedance is 12k Ω for DC currents. During conversion, the external reference must be able to deliver up to 350 μ A DC load current and have an output impedance of 10 Ω or less. The recommended minimum value for the bypass capacitor is 0.1 μ F. If the reference has higher output impedance or is noisy, bypass it close to the REF pin with a 4.7 μ F capacitor.

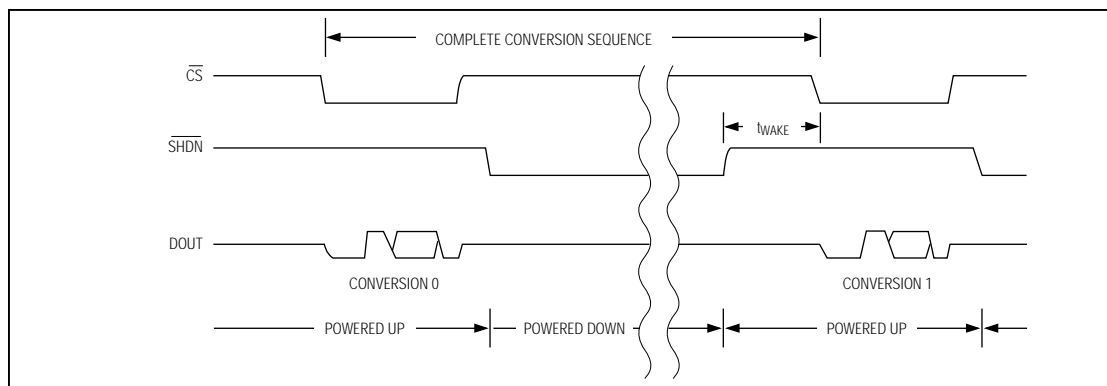

Figure 5. MAX187/MAX189 Shutdown Sequence

+5V, Low-Power, 12-Bit Serial ADCs

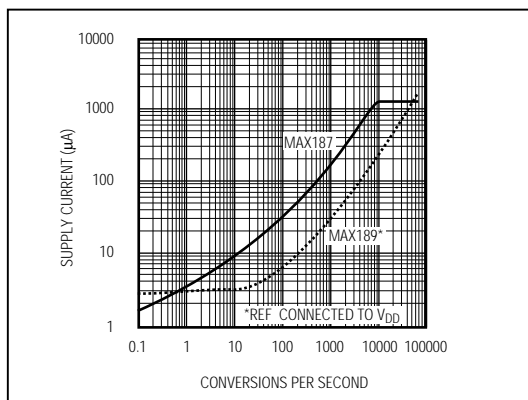

Figure 6. Average Supply Current vs. Conversion Rate

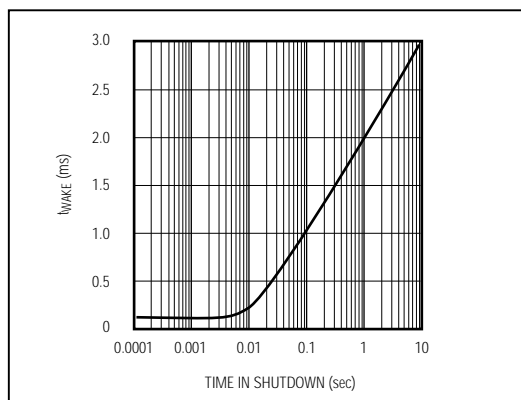

Figure 7. t_{WAKE} vs. Time in Shutdown (MAX187 only)

MAX187/MAX189

Serial Interface

Initialization After Power-Up and Starting a Conversion

When power is first applied, it takes the fully discharged 4.7µF reference bypass capacitor up to 20ms to provide adequate charge for specified accuracy. With \overline{SHDN} not pulled low, the MAX187/MAX189 are now ready to convert.

To start a conversion, pull \overline{CS} low. At \overline{CS} 's falling edge, the T/H enters its hold mode and a conversion is initiated. After an internally timed 8.5µs conversion period, the end of conversion is signaled by DOUT pulling high. Data can then be shifted out serially with the external clock.

Using \overline{SHDN} to Reduce Supply Current

Power consumption can be reduced significantly by shutting down the MAX187/MAX189 between conversions. This is shown in Figure 6, a plot of average supply current vs. conversion rate. Because the MAX189 uses an external reference voltage (assumed to be present continuously), it "wakes up" from shutdown more quickly, and therefore provides lower average supply currents. The wakeup-time, t_{WAKE} , is the time from \overline{SHDN} deasserted to the time when a conversion may be initiated. For the MAX187, this time is 2µs. For the MAX189, this time depends on the time in shutdown (see Figure 7) because the external 4.7µF reference bypass capacitor loses charge slowly during shutdown (see the specifications for shutdown, REF Input Current = 10µA max).

External Clock

The actual conversion does not require the external clock. This frees the µP from the burden of running the SAR conversion clock, and allows the conversion result to be read back at the µP's convenience at any clock rate from 0MHz to 5MHz. The clock duty cycle is unrestricted if each clock phase is at least 100ns. Do not run the clock while a conversion is in progress.

Timing and Control

Conversion-start and data-read operations are controlled by the \overline{CS} and SCLK digital inputs. The timing diagrams of Figures 8 and 9 outline the operation of the serial interface.

A \overline{CS} falling edge initiates a conversion sequence: The T/H stage holds input voltage, the ADC begins to convert, and DOUT changes from high impedance to logic low. SCLK must be kept inactive during the conversion. An internal register stores the data when the conversion is in progress.

End of conversion (EOC) is signaled by DOUT going high. DOUT's rising edge can be used as a framing signal. SCLK shifts the data out of this register any time after the conversion is complete. DOUT transitions on SCLK's falling edge. The next falling clock edge produces the MSB of the conversion at DOUT, followed by the remaining bits. Since there are 12 data bits and one leading high bit, at least 13 falling clock edges are needed to shift out these bits. Extra clock pulses occurring after the conversion result has been clocked out, and prior to a rising edge of \overline{CS} , produce trailing 0s at DOUT and have no effect on converter operation.

+5V, Low-Power, 12-Bit Serial ADCs

MAX187/MAX189

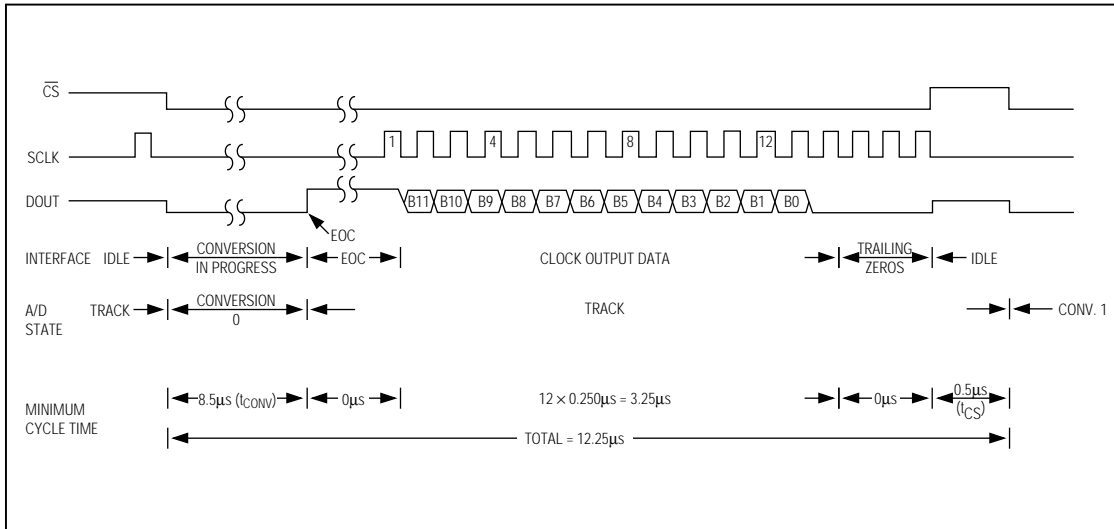

Figure 8. MAX187/MAX189 Interface Timing Sequence

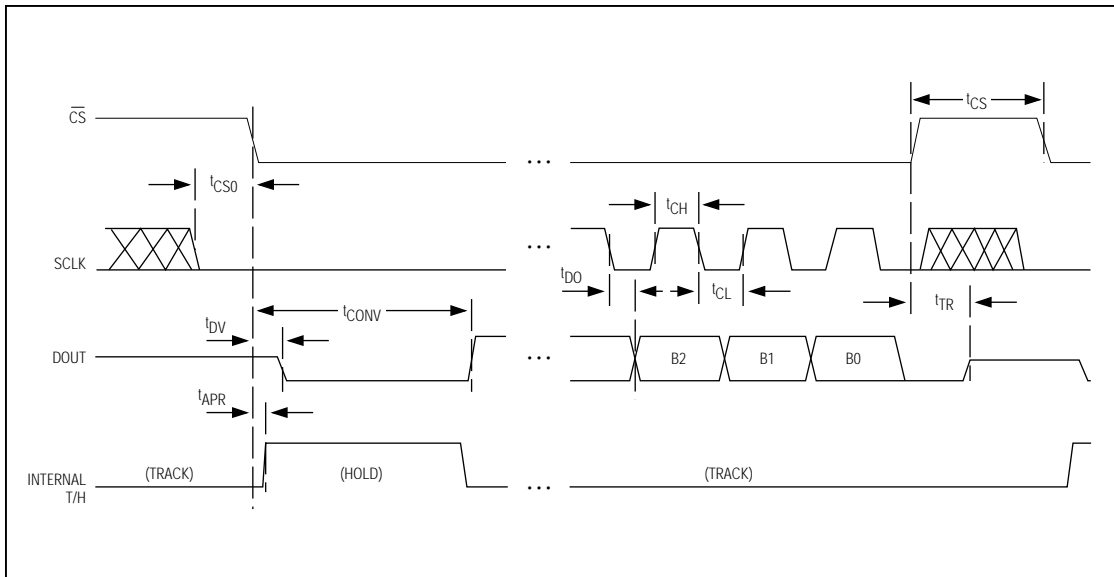

Figure 9. MAX187/MAX189 Detailed Serial-Interface Timing

+5V, Low-Power, 12-Bit Serial ADCs

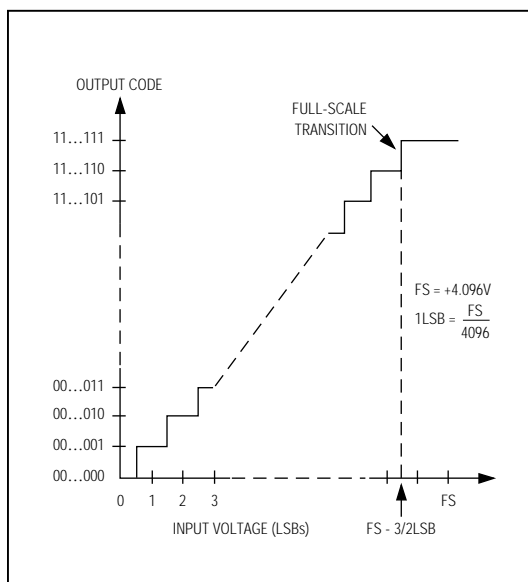

Figure 10. MAX187/MAX189 Unipolar Transfer Function, 4.096V = Full Scale

Minimum cycle time is accomplished by using DOUT's rising edge as the EOC signal. Clock out the data with 13 clock cycles at full speed. Raise \overline{CS} after the conversion's LSB has been read. After the specified minimum time, t_{ACQ} , \overline{CS} can be pulled low again to initiate the next conversion.

Output Coding and Transfer Function

The data output from the MAX187/MAX189 is binary, and Figure 10 depicts the nominal transfer function. Code transitions occur halfway between successive integer LSB values. If $V_{REF} = +4.096V$, then 1 LSB = 1.00mV or $4.096V/4096$.

Dynamic Performance

High-speed sampling capability and a 75ksps throughput make the MAX187/MAX189 ideal for wideband signal processing. To support these and other related applications, Fast Fourier Transform (FFT) test techniques are used to guarantee the ADC's dynamic frequency response, distortion, and noise at the rated throughput. Specifically, this involves applying a low-distortion sine wave to the ADC input and recording the digital conversion results for a specified time. The data is then analyzed using an FFT algorithm that determines its spectral content. Conversion errors are then seen as spectral elements outside of the fundamental

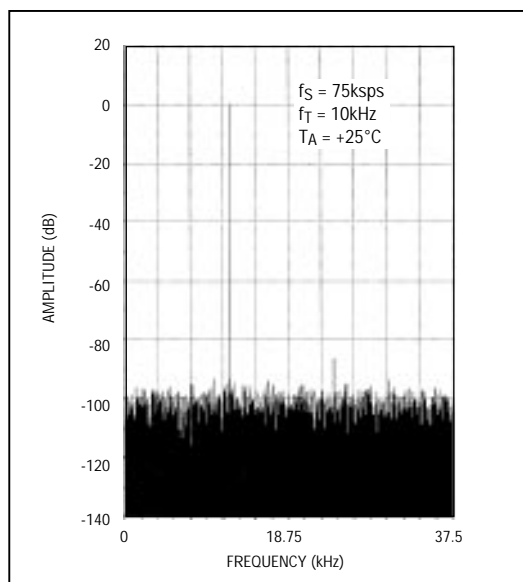

Figure 11. MAX187/MAX189 FFT plot

input frequency. ADCs have traditionally been evaluated by specifications such as Zero and Full-Scale Error, Integral Nonlinearity (INL), and Differential Nonlinearity (DNL). Such parameters are widely accepted for specifying performance with DC and slowly varying signals, but are less useful in signal-processing applications, where the ADC's impact on the system transfer function is the main concern. The significance of various DC errors does not translate well to the dynamic case, so different tests are required.

Signal-to-Noise Ratio and Effective Number of Bits

Signal-to-noise plus distortion (SINAD) is the ratio of the fundamental input frequency's RMS amplitude to the RMS amplitude of all other ADC output signals. The input bandwidth is limited to frequencies above DC and below one-half the ADC sample (conversion) rate.

The theoretical minimum ADC noise is caused by quantization error and is a direct result of the ADC's resolution: $SINAD = (6.02N + 1.76)dB$, where N is the number of bits of resolution. An ideal 12-bit ADC can, therefore, do no better than 74dB. An FFT plot of the output shows the output level in various spectral bands. Figure 11 shows the result of sampling a pure 10kHz sine wave at a 75ksps rate with the MAX187/MAX189.

+5V, Low-Power, 12-Bit Serial ADCs

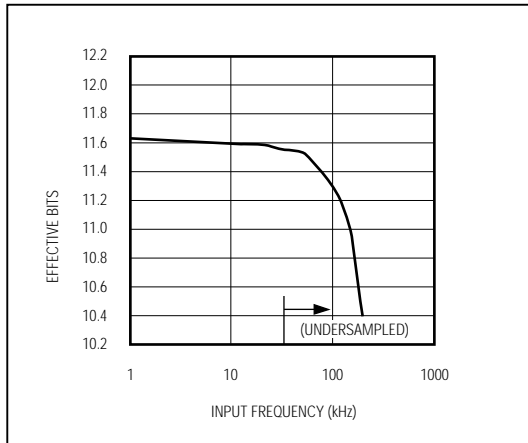

Figure 12. Effective Bits vs. Input Frequency

The effective resolution (effective number of bits) the ADC provides can be determined by transposing the above equation and substituting in the measured SINAD: $N = (\text{SINAD} - 1.76)/6.02$. Figure 12 shows the effective number of bits as a function of the input frequency for the MAX187/MAX189.

Total Harmonic Distortion

If a pure sine wave is sampled by an ADC at greater than the Nyquist frequency, the nonlinearities in the ADC's transfer function create harmonics of the input frequency present in the sampled output data.

Total Harmonic Distortion (THD) is the ratio of the RMS sum of all the harmonics (in the frequency band above DC and below one-half the sample rate, but not including the DC component) to the RMS amplitude of the fundamental frequency. This is expressed as follows:

$$\text{THD} = 20 \log \frac{\sqrt{V_2^2 + V_3^2 + V_4^2 + \dots + V_N^2}}{V_1}$$

where V_1 is the fundamental RMS amplitude, and V_2 through V_N are the amplitudes of the 2nd through Nth harmonics. The THD specification in the *Electrical Characteristics* includes the 2nd through 5th harmonics.

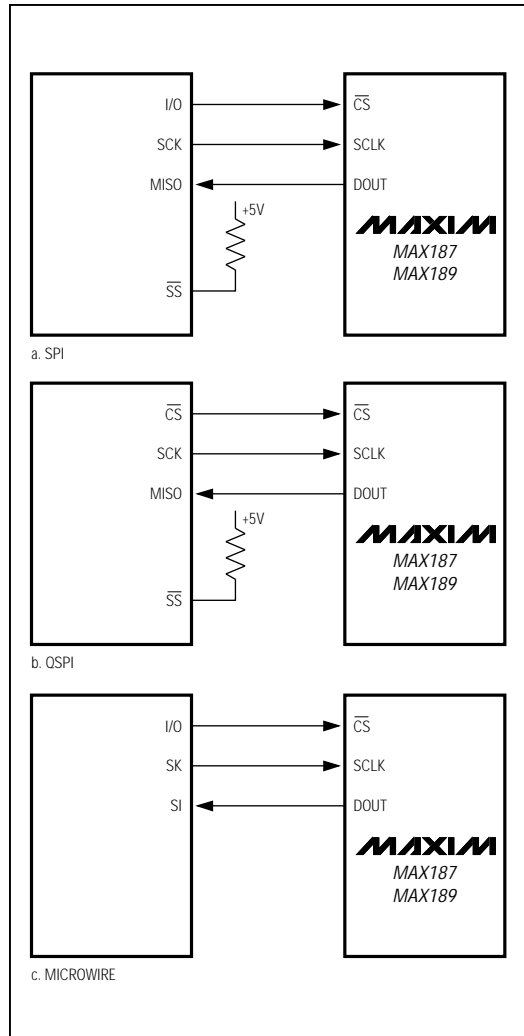

Figure 13. Common Serial-Interface Connections to the MAX187/MAX189

+5V, Low-Power, 12-Bit Serial ADCs

Applications Information

Connection to Standard Interfaces

The MAX187/MAX189 serial interface is fully compatible with SPI, QSPI, and Microwire standard serial interfaces.

If a serial interface is available, set the CPU's serial interface in master mode so the CPU generates the serial clock. Choose a clock frequency up to 2.5MHz.

1. Use a general-purpose I/O line on the CPU to pull \overline{CS} low. Keep SCLK low.
2. Wait for the maximum conversion time specified before activating SCLK. Alternatively, look for a DOUT rising edge to determine the end of conversion.
3. Activate SCLK for a minimum of 13 clock cycles. The first falling clock edge will produce the MSB of the DOUT conversion. DOUT output data transitions on

SCLK's falling edge and is available in MSB-first format. Observe the SCLK to DOUT valid timing characteristic. Data can be clocked into the μP on SCLK's rising edge.

4. Pull \overline{CS} high at or after the 13th falling clock edge. If \overline{CS} remains low, trailing zeros are clocked out after the LSB.
5. With \overline{CS} = high, wait the minimum specified time, t_{CS} , before launching a new conversion by pulling \overline{CS} low. If a conversion is aborted by pulling \overline{CS} high before the conversions end, wait for the minimum acquisition time, t_{ACQ} , before starting a new conversion.

Data can be output in 1-byte chunks or continuously, as shown in Figure 8. The bytes will contain the result of the conversion padded with one leading 1, and trailing 0s if SCLK is still active with \overline{CS} kept low.

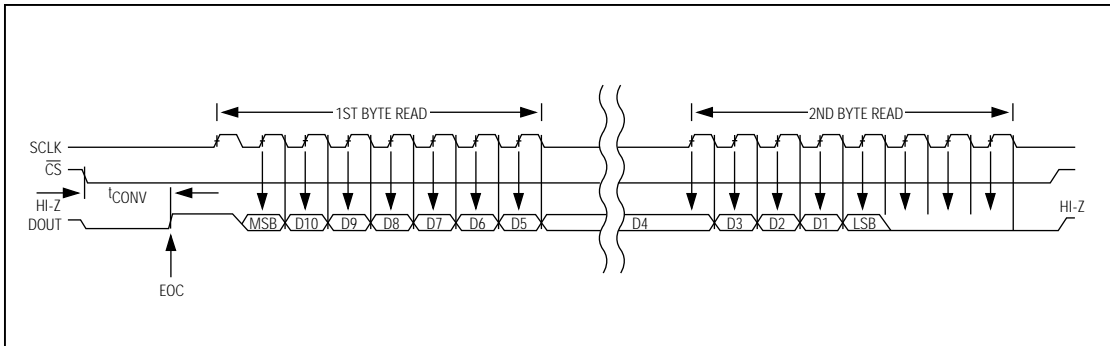

Figure 14. SPI/Microwire Serial Interface Timing ($CPOL = CPHA = 0$)

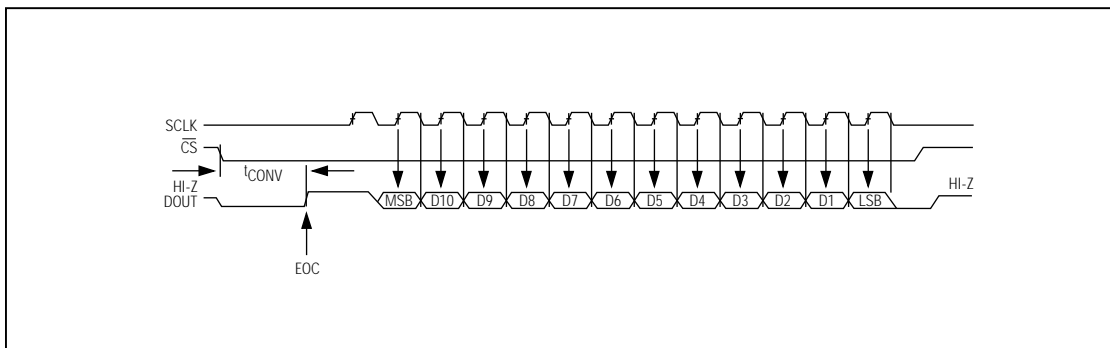

Figure 15. QSPI Serial Interface Timing ($CPOL = CPHA = 0$)

+5V, Low-Power, 12-Bit Serial ADCs

The ADC results are transmitted across a 1500V isolation barrier provided by three 6N136 opto-isolators. Isolated power must be supplied to the converter and the isolated side of the opto-couplers. 74HC595 three-state shift registers are used to construct a 12-bit parallel data output. The timing sequence is identical to the timing shown in Figure 8. Conversion speed is limited by the delay through the opto-isolators. With a 140kHz clock, conversion time is 100 μ s.

The universal 12-bit parallel data output can also be used without the isolation stage when a parallel interface is required. Clock frequencies up to 2.9MHz are possible without violating the 20ns shift-register setup time. Delay or invert the clock signal to the shift registers beyond 2.9MHz.

Layout, Grounding, Bypassing

For best performance, use printed circuit boards. Wire-wrap boards are not recommended. Board layout should ensure that digital and analog signal lines are separated from each other. Do not run analog and digital (especially clock) lines parallel to one another, or digital lines underneath the ADC package.

Figure 17 shows the recommended system ground connections. A single-point analog ground ("star" ground point) should be established at GND, separate from the logic ground. All other analog grounds should be connected to this ground. The 16-pin versions also have a dedicated DGND pin available. Connect DGND to this star ground point for further noise reduction. No other digital system ground should be connected to this single-point analog ground. The ground return to the power supply for this ground should be low impedance and as short as possible for noise-free operation.

High-frequency noise in the V_{DD} power supply may affect the ADC's high-speed comparator. Bypass this supply to the single-point analog ground with 0.01 μ F and 4.7 μ F bypass capacitors. Minimize capacitor lead lengths for best supply-noise rejection. If the +5V power supply is very noisy, a 10 Ω resistor can be connected as a lowpass filter to attenuate supply noise (Figure 17).

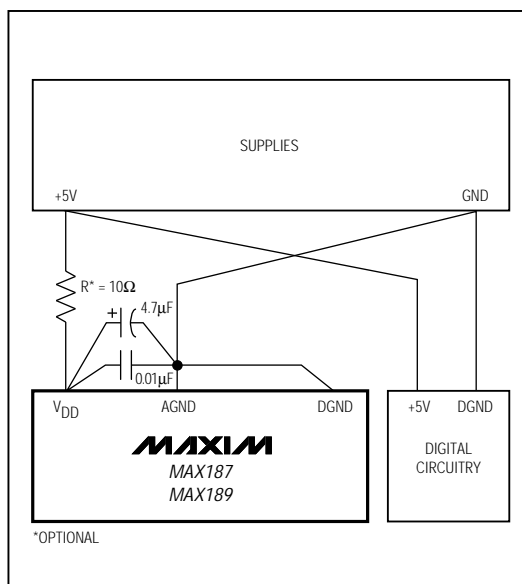

Figure 17. Power-Supply Grounding Condition

MAX187/MAX189

+5V, Low-Power, 12-Bit Serial ADCs

__ Ordering Information (continued)

| PART | TEMP. RANGE | PIN-PACKAGE | ERROR (LSB) |
|-------------------|-----------------|---------------|------------------|
| MAX187AEPA | -40°C to +85°C | 8 Plastic DIP | $\pm\frac{1}{2}$ |
| MAX187BEPA | -40°C to +85°C | 8 Plastic DIP | ± 1 |
| MAX187CEPA | -40°C to +85°C | 8 Plastic DIP | ± 2 |
| MAX187AEWE | -40°C to +85°C | 16 Wide SO | $\pm\frac{1}{2}$ |
| MAX187BEWE | -40°C to +85°C | 16 Wide SO | ± 1 |
| MAX187CEWE | -40°C to +85°C | 16 Wide SO | ± 2 |
| MAX187AMJA | -55°C to +125°C | 8 CERDIP** | $\pm\frac{1}{2}$ |
| MAX187BMJA | -55°C to +125°C | 8 CERDIP** | ± 1 |
| MAX189ACPA | 0°C to +70°C | 8 Plastic DIP | $\pm\frac{1}{2}$ |
| MAX189BCPA | 0°C to +70°C | 8 Plastic DIP | ± 1 |
| MAX189CCPA | 0°C to +70°C | 8 Plastic DIP | ± 2 |
| MAX189ACWE | 0°C to +70°C | 16 Wide SO | $\pm\frac{1}{2}$ |
| MAX189BCWE | 0°C to +70°C | 16 Wide SO | ± 1 |
| MAX189CCWE | 0°C to +70°C | 16 Wide SO | ± 2 |
| MAX189BC/D | 0°C to +70°C | Dice* | ± 1 |
| MAX189AEPA | -40°C to +85°C | 8 Plastic DIP | $\pm\frac{1}{2}$ |
| MAX189BEPA | -40°C to +85°C | 8 Plastic DIP | ± 1 |
| MAX189CEPA | -40°C to +85°C | 8 Plastic DIP | ± 2 |
| MAX189AEWE | -40°C to +85°C | 16 Wide SO | $\pm\frac{1}{2}$ |
| MAX189BEWE | -40°C to +85°C | 16 Wide SO | ± 1 |
| MAX189CEWE | -40°C to +85°C | 16 Wide SO | ± 2 |
| MAX189AMJA | -55°C to +125°C | 8 CERDIP** | $\pm\frac{1}{2}$ |
| MAX189BMJA | -55°C to +125°C | 8 CERDIP** | ± 1 |

* Dice are specified at $T_A = +25^\circ\text{C}$, DC parameters only.

**Contact factory for availability and processing to MIL-STD-883.

___ Pin Configurations (continued)

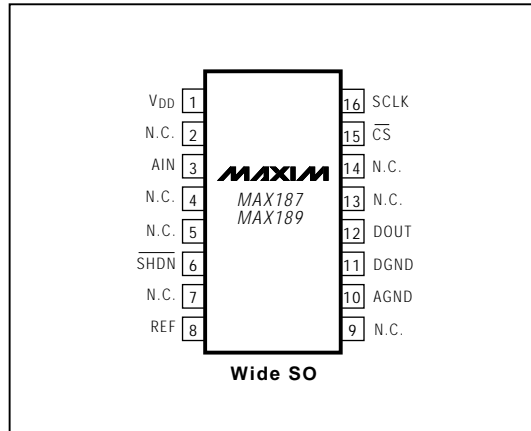

+5V, Low-Power, 12-Bit Serial ADCs

Chip Topography

MAX187/MAX189

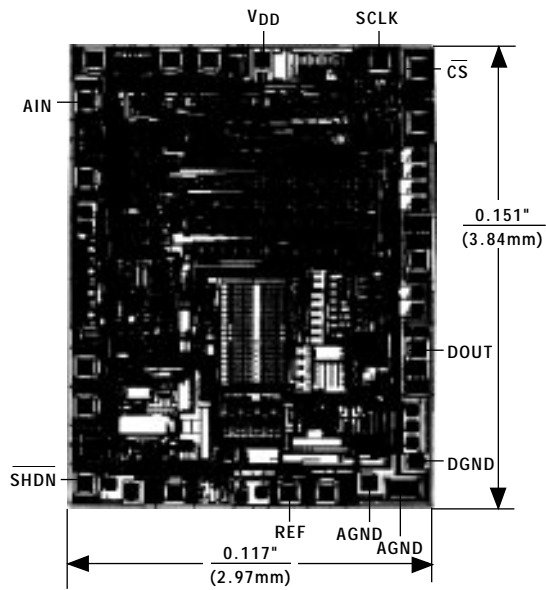

TRANSISTOR COUNT: 2278;
SUBSTRATE CONNECTED TO V_{DD}.

MAX187/MAX189

+5V, Low-Power, 12-Bit Serial ADCs

Package Information

**P PACKAGE
PLASTIC
DUAL-IN-LINE**

| DIM | INCHES | | MILLIMETERS | |
|-----|--------|-------|-------------|-------|
| | MIN | MAX | MIN | MAX |
| A | – | 0.200 | – | 5.08 |
| A1 | 0.015 | – | 0.38 | – |
| A2 | 0.125 | 0.175 | 3.18 | 4.45 |
| A3 | 0.055 | 0.080 | 1.40 | 2.03 |
| B | 0.016 | 0.020 | 0.41 | 0.51 |
| B1 | 0.045 | 0.065 | 1.14 | 1.65 |
| C | 0.008 | 0.012 | 0.20 | 0.30 |
| D1 | 0.050 | 0.090 | 1.27 | 2.29 |
| E | 0.600 | 0.625 | 15.24 | 15.88 |
| E1 | 0.525 | 0.575 | 13.34 | 14.61 |
| e | 0.100 | – | 2.54 | – |
| eA | 0.600 | – | 15.24 | – |
| eB | – | 0.700 | – | 17.78 |
| L | 0.120 | 0.150 | 3.05 | 3.81 |

| DIM | PINS | INCHES | | MILLIMETERS | |
|-----|------|--------|-------|-------------|-------|
| | | MIN | MAX | MIN | MAX |
| D | 24 | 1.230 | 1.270 | 31.24 | 32.26 |
| D | 28 | 1.430 | 1.470 | 36.32 | 37.34 |
| D | 40 | 2.025 | 2.075 | 51.44 | 52.71 |

**W PACKAGE
SMALL
OUTLINE**

| DIM | INCHES | | MILLIMETERS | |
|-----|--------|-------|-------------|-------|
| | MIN | MAX | MIN | MAX |
| A | 0.093 | 0.104 | 2.35 | 2.65 |
| A1 | 0.004 | 0.012 | 0.10 | 0.30 |
| B | 0.014 | 0.019 | 0.35 | 0.49 |
| C | 0.009 | 0.013 | 0.23 | 0.32 |
| E | 0.291 | 0.299 | 7.40 | 7.60 |
| e | – | 0.050 | – | 1.27 |
| H | 0.394 | 0.419 | 10.00 | 10.65 |
| L | 0.016 | 0.050 | 0.40 | 1.27 |

| DIM | PINS | INCHES | | MILLIMETERS | |
|-----|------|--------|-------|-------------|-------|
| | | MIN | MAX | MIN | MAX |
| D | 16 | 0.398 | 0.413 | 10.10 | 10.50 |
| D | 18 | 0.447 | 0.463 | 11.35 | 11.75 |
| D | 20 | 0.496 | 0.512 | 12.60 | 13.00 |
| D | 24 | 0.598 | 0.614 | 15.20 | 15.60 |
| D | 28 | 0.697 | 0.713 | 17.70 | 18.10 |

21-0042A

Maxim cannot assume responsibility for use of any circuitry other than circuitry entirely embodied in a Maxim product. No circuit patent licenses are implied. Maxim reserves the right to change the circuitry and specifications without notice at any time.

20 _____ Maxim Integrated Products, 120 San Gabriel Drive, Sunnyvale, CA 94086 (408) 737-7600