

## 74ALVC162838

### Low Voltage 16-Bit Selectable Register/Buffer with 3.6V Tolerant Inputs/Outputs and 26Ω Series Resistors in the Outputs

#### General Description

The ALVC162838 contains sixteen non-inverting selectable buffered or registered paths. The device can be configured to operate in a registered, or flow through buffer mode by utilizing the register enable (REGE) and Clock (CLK) signals. The device operates in a 16-bit word wide mode. All outputs can be placed into 3-State through the use of the  $\overline{OE}$  pin. These devices are ideally suited for buffered or registered 168 pin and 200 pin SDRAM DIMM memory modules.

The 74ALVC162838 is designed for low voltage (1.65V to 3.6V)  $V_{CC}$  applications with I/O compatibility up to 3.6V. The ALVC162838 is also designed with 26Ω series resistors in the outputs. This design reduces line noise in applications such as memory address drivers, clock drivers, and bus transceivers/transmitters.

The 74ALVC162838 is fabricated with an advanced CMOS technology to achieve high speed operation while maintaining low CMOS power dissipation.

#### Features

- Compatible with PC100 and PC133 DIMM module specifications
- 1.65V–3.6V  $V_{CC}$  supply operation
- 3.6V tolerant inputs and outputs
- 26Ω series resistors in the outputs
- $t_{PD}$  (CLK to  $O_n$ )
  - 4.4 ns max for 3.0V to 3.6V  $V_{CC}$
  - 5.9 ns max for 2.3V to 2.7V  $V_{CC}$
  - 9.8 ns max for 1.65V to 1.95V  $V_{CC}$
- Power-off high impedance inputs and outputs
- Supports live insertion and withdrawal (Note 1)
- Uses patented noise/EMI reduction circuitry
- Latchup conforms to JEDEC JED78
- ESD performance:
  - Human body model > 2000V
  - Machine model > 200V

**Note 1:** To ensure the high-impedance state during power up or power down,  $\overline{OE}$  should be tied to  $V_{CC}$  through a pull-up resistor. The minimum value of the resistor is determined by the current -sourcing capability of the driver.

#### Ordering Code:

Ordering Code	Package Number	Package Descriptions
74ALVC162838T	MTD48	48-Lead Thin Shrink Small Outline Package (TSSOP), JEDEC MO-153, 6.1mm Wide

Devices also available in Tape and Reel. Specify by appending suffix letter "X" to the ordering code.

#### Logic Symbol

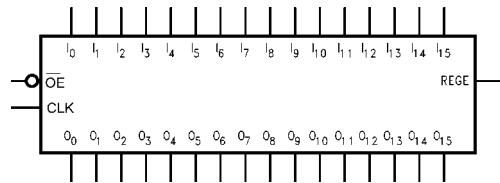

#### Pin Descriptions

Pin Names	Description
$\overline{OE}$	Output Enable Input (Active LOW)
$I_0$ – $I_{15}$	Inputs
$O_0$ – $O_{15}$	Outputs
CLK	Clock Input
REGE	Register Enable Input

### Connection Diagram

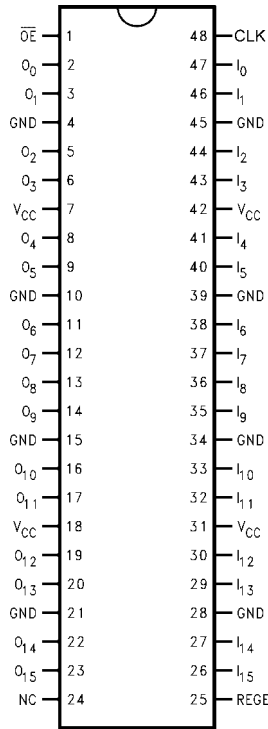

### Truth Table

Inputs				Outputs
CLK	REGE	I <sub>n</sub>	$\overline{OE}$	O <sub>n</sub>
↑	H	H	L	H
↑	H	L	L	L
X	L	H	L	H
X	L	L	L	L
X	X	X	H	Z

H = Logic HIGH  
 L = Logic LOW  
 X = Don't Care, but not floating  
 Z = High Impedance  
 ↑ = LOW-to-HIGH Clock Transition

### Functional Description

The 74ALVC162838 consists of sixteen selectable non-inverting buffers or registers with word wide modes. Mode functionality is selected through operation of the CLK and REGE pin as shown by the truth table. When REGE is held at a logic HIGH the device operates as a 16-bit register. Data is transferred from I<sub>n</sub> to O<sub>n</sub> on the rising edge of the CLK input. When the REGE pin is held at a logic LOW the device operates in a flow through mode and data propagates directly from the I to the O outputs. All outputs can be 3-stated by holding the  $\overline{OE}$  pin at a logic HIGH.

### Logic Diagram

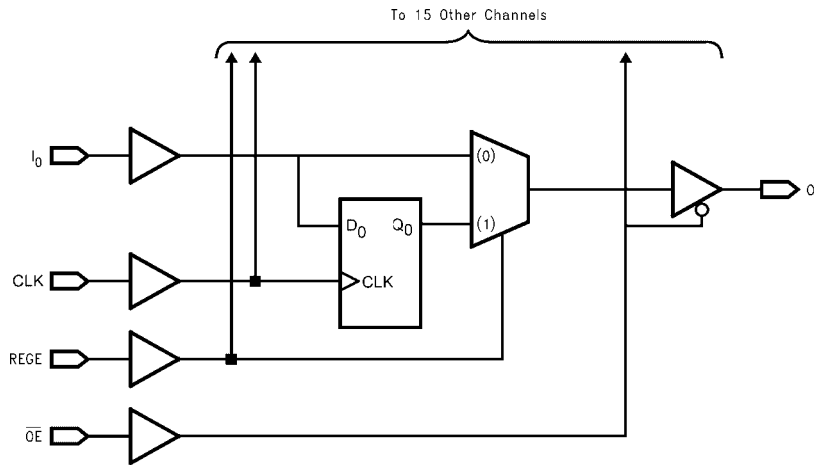

**Absolute Maximum Ratings** (Note 2)

Supply Voltage ( $V_{CC}$ )	-0.5V to +4.6V
DC Input Voltage ( $V_I$ )	-0.5V to 4.6V
Output Voltage ( $V_O$ ) (Note 3)	-0.5V to $V_{CC} + 0.5V$
DC Input Diode Current ( $I_{IK}$ )	
$V_I < 0V$	-50 mA
DC Output Diode Current ( $I_{OK}$ )	
$V_O < 0V$	-50 mA
DC Output Source/Sink Current ( $I_{OH}/I_{OL}$ )	$\pm 50$ mA
DC $V_{CC}$ or GND Current per Supply Pin ( $I_{CC}$ or GND)	$\pm 100$ mA
Storage Temperature Range ( $T_{STG}$ )	-65°C to +150°C

**Recommended Operating Conditions** (Note 4)

Power Supply	
Operating	1.65V to 3.6V
Input Voltage	0V to $V_{CC}$
Output Voltage ( $V_O$ )	0V to $V_{CC}$
Free Air Operating Temperature ( $T_A$ )	-40°C to +85°C
Minimum Input Edge Rate ( $\Delta t/\Delta V$ )	
$V_{IN} = 0.8V$ to 2.0V, $V_{CC} = 3.0V$	10 ns/V

**Note 2:** The Absolute Maximum Ratings are those values beyond which the safety of the device cannot be guaranteed. The device should not be operated at these limits. The parametric values defined in the Electrical Characteristics tables are not guaranteed at the Absolute Maximum Ratings. The "Recommended Operating Conditions" table will define the conditions for actual device operation.

**Note 3:**  $I_O$  Absolute Maximum Rating must be observed.

**Note 4:** Floating or unused control inputs must be held HIGH or LOW.

**DC Electrical Characteristics**

Symbol	Parameter	Conditions	$V_{CC}$ (V)	Min	Max	Units
$V_{IH}$	HIGH Level Input Voltage		1.65 - 1.95 2.3 - 2.7 2.7 - 3.6	$0.65 \times V_{CC}$ 1.7 2.0		V
$V_{IL}$	LOW Level Input Voltage		1.65 - 1.95 2.3 - 2.7 2.7 - 3.6		$0.35 \times V_{CC}$ 0.7 0.8	V
$V_{OH}$	HIGH Level Output Voltage	$I_{OH} = -100 \mu A$	1.65 - 3.6	$V_{CC} - 0.2$		V
		$I_{OH} = -2$ mA	1.65	1.2		
		$I_{OH} = -4$ mA	2.3	1.9		
		$I_{OH} = -6$ mA	2.3	1.7		
		$I_{OH} = -8$ mA	3.0	2.4		
		$I_{OH} = -12$ mA	2.7	2		
$V_{OL}$	LOW Level Output Voltage	$I_{OL} = 100 \mu A$	1.65 - 3.6		0.2	V
		$I_{OL} = 2$ mA	1.65		0.45	
		$I_{OL} = 4$ mA	2.3		0.4	
		$I_{OL} = 6$ mA	2.3		0.55	
		$I_{OL} = 8$ mA	3.0		0.55	
		$I_{OL} = 12$ mA	2.7		0.6	
$I_I$	Input Leakage Current	$0 \leq V_I \leq 3.6V$	1.65 - 3.6		$\pm 5.0$	$\mu A$
$I_{OZ}$	3-STATE Output Leakage	$0 \leq V_O \leq 3.6V$ , $V_I = V_{IH}$ or $V_{IL}$	1.65 - 3.6		$\pm 10$	$\mu A$
$I_{OFF}$	Power Off Leakage Current	$0V \leq (V_I, V_O) \leq 3.6V$	0		10	mA
$I_{CC}$	Quiescent Supply Current	$V_I = V_{CC}$ or GND, $I_O = 0$	3.6		40	$\mu A$
$\Delta I_{CC}$	Increase in $I_{CC}$ per Input	$V_{IH} = V_{CC} - 0.6V$	2.7 - 3.6		750	$\mu A$

## AC Electrical Characteristics

Symbol	Parameter	$T_A = -40^\circ\text{C to } +85^\circ\text{C}, R_L = 500\Omega$								Units
		$C_L = 50\text{ pF}$				$C_L = 30\text{ pF}$				
		$V_{CC} = 3.3V \pm 0.3V$		$V_{CC} = 2.7V$		$V_{CC} = 2.5 \pm 0.2V$		$V_{CC} = 1.8V \pm 0.15V$		
		Min	Max	Min	Max	Min	Max	Min	Max	
$f_{MAX}$	Maximum Clock Frequency	250		200		200		100		MHz
$t_{PHL}, t_{PLH}$	Propagation Delay Bus-to-Bus (REGE = 0)	1.3	4.0	1.5	5.4	1.0	4.9	1.5	9.8	ns
$t_{PHL}, t_{PLH}$	Propagation Delay Clock to Bus (REGE = 1)	1.3	4.4	1.5	5.9	1.0	5.4	1.5	9.8	ns
$t_{PHL}, t_{PLH}$	Propagation Delay REGE to Bus	1.3	4.4	1.5	5.9	1.0	5.4	1.5	9.8	ns
$t_{PZL}, t_{PZH}$	Output Enable Time	1.3	4.5	1.5	6.2	1.0	5.7	1.5	9.8	ns
$t_{PLZ}, t_{PHZ}$	Output Disable Time	1.3	4.6	1.5	5.1	1.0	4.6	1.5	8.3	ns
$t_S$	Setup Time	1.0		1.0		1.0		2.5		ns
$t_H$	Hold Time	0.7		0.7		0.7		1.0		ns
$t_W$	Pulse Width	1.5		1.5		1.5		4.0		ns

## Capacitance

Symbol	Parameter	Conditions	$T_A = +25^\circ\text{C}$		Units	
			$V_{CC}$	Typical		
$C_{IN}$	Input Capacitance	$V_I = 0V$ or $V_{CC}$	3.3	6	pF	
$C_{OUT}$	Output Capacitance	$V_I = 0V$ or $V_{CC}$	3.3	7	pF	
$C_{PD}$	Power Dissipation Capacitance	Outputs Enabled	$f = 10\text{ MHz}, C_L = 0\text{ pF}$	3.3	20	pF
				2.5	20	

## AC Loading and Waveforms

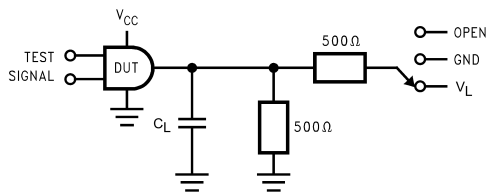

FIGURE 1. AC Test Circuit

TABLE 1. Values for Figure 1

TEST	SWITCH
$t_{PLH}$ , $t_{PHL}$	Open
$t_{PZL}$ , $t_{PLZ}$	$V_L$
$t_{PZH}$ , $t_{PHZ}$	GND

TABLE 2. Variable Matrix  
(Input Characteristics:  $f = 1\text{MHz}$ ;  $t_r = t_f = 2\text{ns}$ ;  $Z_0 = 50\Omega$ )

Symbol	$V_{CC}$			
	$3.3\text{V} \pm 0.3\text{V}$	$2.7\text{V}$	$2.5\text{V} \pm 0.2\text{V}$	$1.8\text{V} \pm 0.15\text{V}$
$V_{mi}$	1.5V	1.5V	$V_{CC}/2$	$V_{CC}/2$
$V_{mo}$	1.5V	1.5V	$V_{CC}/2$	$V_{CC}/2$
$V_X$	$V_{OL} + 0.3\text{V}$	$V_{OL} + 0.3\text{V}$	$V_{OL} + 0.15\text{V}$	$V_{OL} + 0.15\text{V}$
$V_Y$	$V_{OH} - 0.3\text{V}$	$V_{OH} - 0.3\text{V}$	$V_{OH} - 0.15\text{V}$	$V_{OH} - 0.15\text{V}$
$V_L$	6V	6V	$V_{CC} \times 2$	$V_{CC} \times 2$

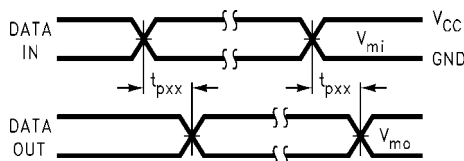

FIGURE 2. Waveform for Inverting and Non-Inverting Functions

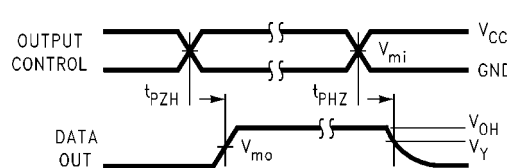

FIGURE 3. 3-STATE Output High Enable and Disable Times for Low Voltage Logic

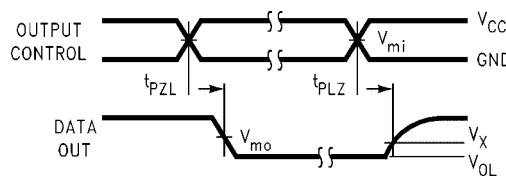

FIGURE 4. 3-STATE Output Low Enable and Disable Times for Low Voltage Logic

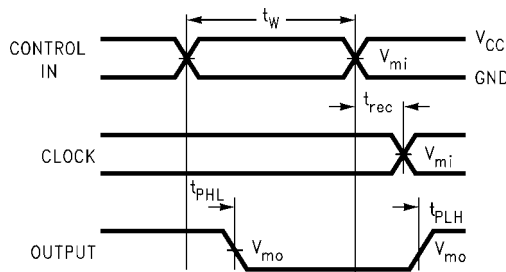

FIGURE 5. Propagation Delay, Pulse Width and  $t_{rec}$  Waveforms

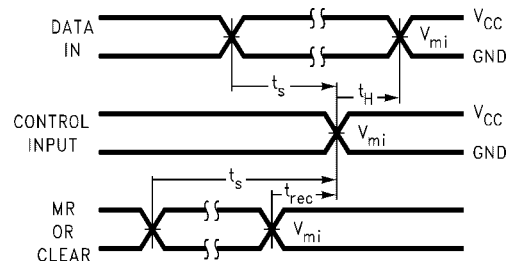
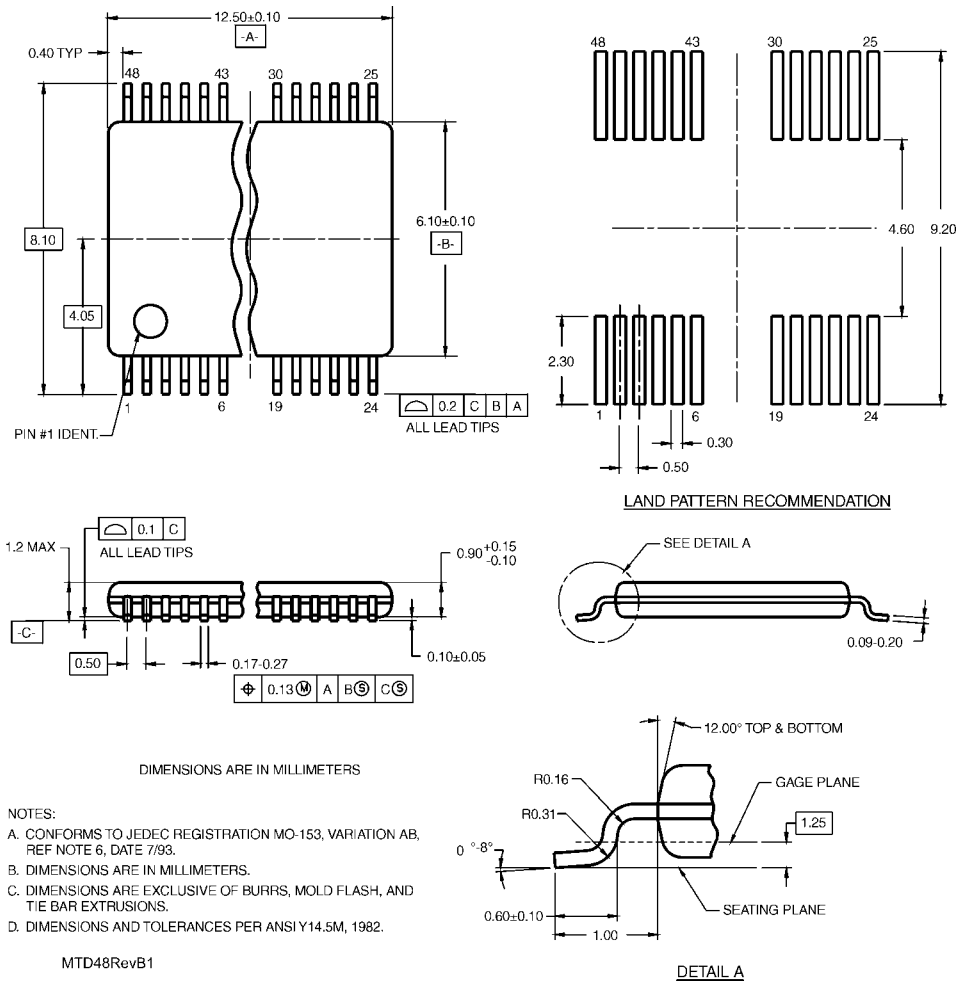

FIGURE 6. Setup Time, Hold Time and Recovery Time for Low Voltage Logic

**Physical Dimensions** inches (millimeters) unless otherwise noted



Fairchild does not assume any responsibility for use of any circuitry described, no circuit patent licenses are implied and Fairchild reserves the right at any time without notice to change said circuitry and specifications.

**LIFE SUPPORT POLICY**

FAIRCHILD'S PRODUCTS ARE NOT AUTHORIZED FOR USE AS CRITICAL COMPONENTS IN LIFE SUPPORT DEVICES OR SYSTEMS WITHOUT THE EXPRESS WRITTEN APPROVAL OF THE PRESIDENT OF FAIRCHILD SEMICONDUCTOR CORPORATION. As used herein:

1. Life support devices or systems are devices or systems which, (a) are intended for surgical implant into the body, or (b) support or sustain life, and (c) whose failure to perform when properly used in accordance with instructions for use provided in the labeling, can be reasonably expected to result in a significant injury to the user.
2. A critical component in any component of a life support device or system whose failure to perform can be reasonably expected to cause the failure of the life support device or system, or to affect its safety or effectiveness.

[www.fairchildsemi.com](http://www.fairchildsemi.com)