

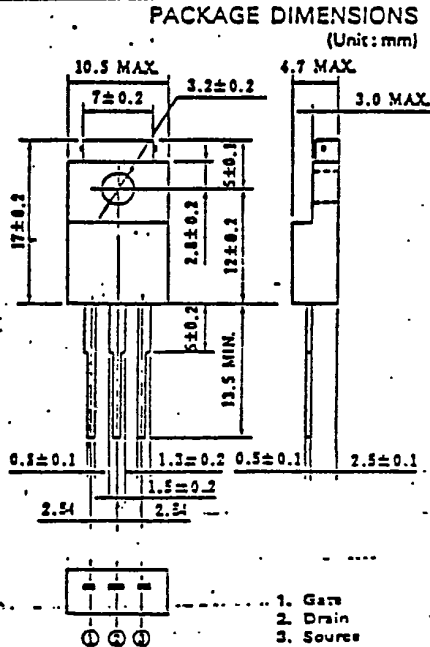

MOS FIELD EFFECT TRANSISTOR

2SJ142

**FAST SWITCHING
P-CHANNEL SILICON POWER MOS FET**



Features

- Suitable for switching power supplies, actuator controls and pulse circuits
- 4V Gate Drive — Logic Level —
- Large current switching : $I_D(DC)=13A$
- Low $R_{DS(on)}$
- No Secondary Breakdown

Absolute Maximum Ratings ($T_a=25^\circ C$)

Drain to Source Voltage	V_{DS}	-100V
Gate to Source Voltage	V_{GS}	$\pm 20V$
Continuous Drain Current	$I_D(DC)$	$\pm 13A$
Pulse Drain Current	$I_D(pulse)$	$\pm 52A$
Total Power Dissipation	PT	2.0W
Total Power Dissipation	PT**	35W
Channel Temperature	T_{ch}	150 °C
Storage Temperature	T_{stg}	-55to+150 °C

* $T_{ch} \leq 150^\circ C$
** $T_c=25^\circ C$

Electrical Characteristics ($T_a=25^\circ C$)

Characteristics	Symbol	Min.	Typ.	Max.	Unit	Test Conditions
Drain Leakage Current	I_{DSS}			- 10	μA	$V_{DS}=-100V, V_{GS}=0$
Gate to Source Leakage Current	I_{GSS}			100	nA	$V_{GS}=20V, V_{DS}=0$
Gate to Source Cutoff Voltage	$V_{GS(off)}$	-1.0		-3.0	V	$V_{DS}=-10V, I_D=-1.0mA$
Forward Transfer Admittance	$ y_{fs} $	5.0			S	$V_{DS}=-10V, I_D=-10A$
Drain to Source On-State Resistance	$R_{DS(on)}$			0.2	Ω	$V_{GS}=-10V, I_D=-10A$
Drain to Source On-State Resistance	$R_{DS(on)}$			0.3	Ω	$V_{GS}=-1.0V, I_D=-3.0A$
Input Capacitance	C_{iss}		3200		pF	$V_{DS}=-10V$
Output Capacitance	C_{oss}		700		pF	$V_{GS}=0$
Reverse Transfer Capacitance	C_{rss}		150		pF	$f=1.0MHz$
Turn-On Delay Time	$t_d(on)$		18		ns	$I_D=-10A$
Rise Time	t_r		100		ns	$V_{GS(on)}=-10V$
Turn-Off Delay Time	$t_d(off)$		90		ns	$V_{CC}=-50V$
Fall Time	t_f		100		ns	$R_L=5\Omega$

NEC cannot assume any responsibility for any circuits shown or represent that they are free from patent infringement.

TURN-ON AND TURN-OFF TIME TEST CIRCUIT

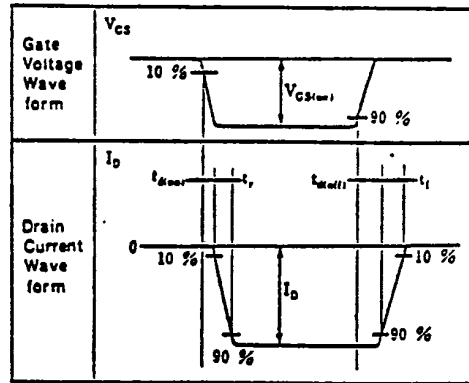
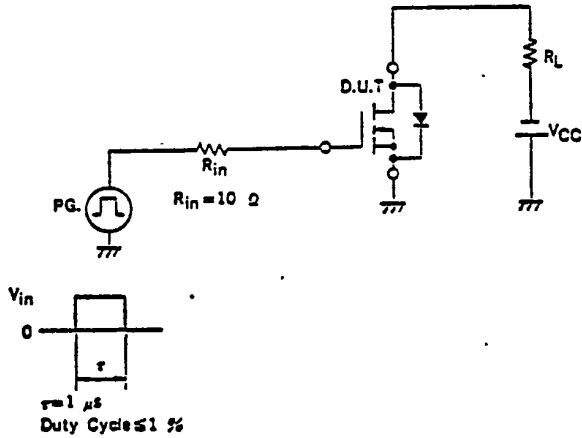

DERATING FACTOR OF FORWARD BIAS SAFE OPERATING AREA

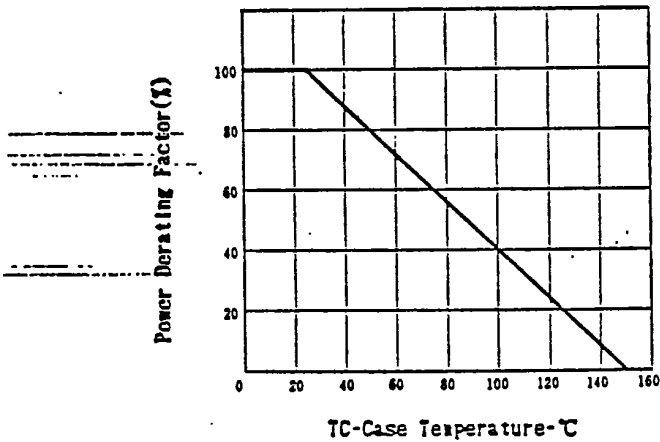

FORWARD BIAS SAFE OPERATING AREA

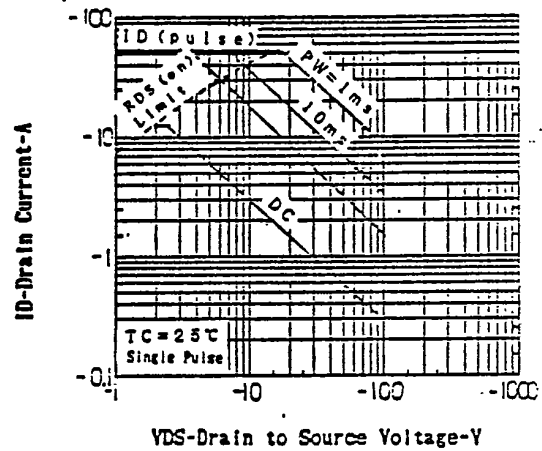

TOTAL POWER DISSIPATION vs. CASE TEMPERATURE

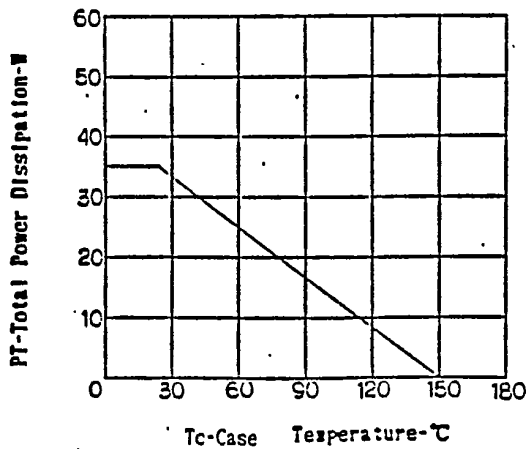

DRAIN CURRENT vs. DRAIN TO SOURCE VOLTAGE

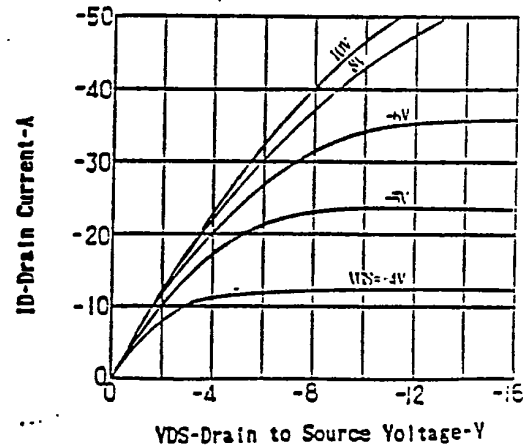

FORWARD TRANSFER ADMITTANCE vs. DRAIN CURRENT

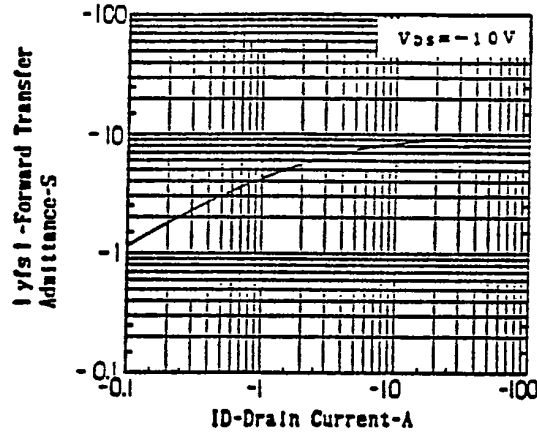

SOURCE TO DRAIN DIODE FORWARD VOLTAGE

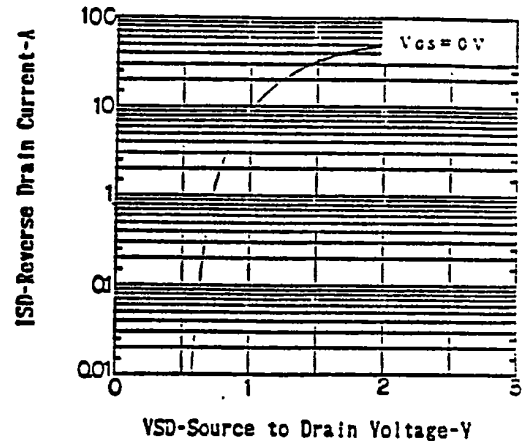

CAPACITANCE vs. DRAIN TO SOURCE VOLTAGE

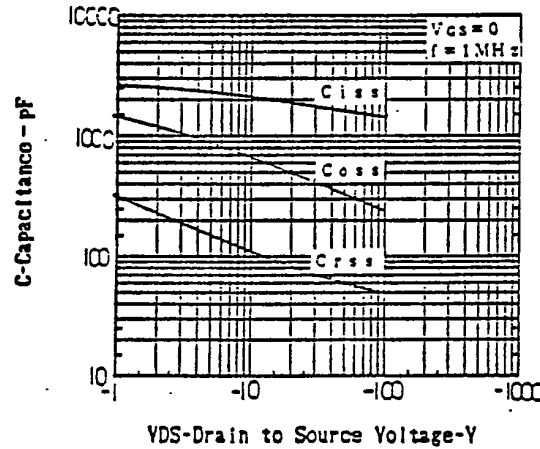

DRAIN TO SOURCE ON-STATE RESISTANCE vs. GATE TO SOURCE VOLTAGE

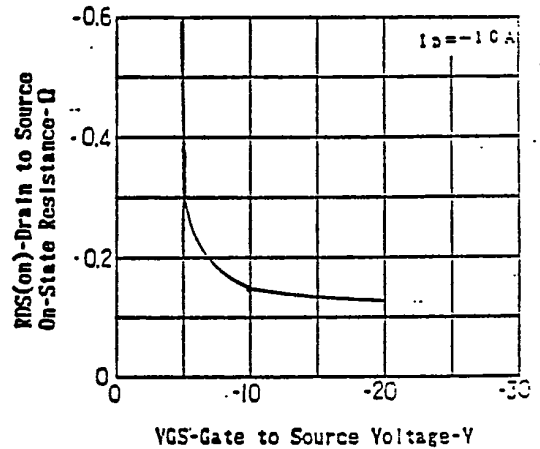

DRAIN TO SOURCE ON-STATE RESISTANCE vs. CHANNEL TEMPERATURE

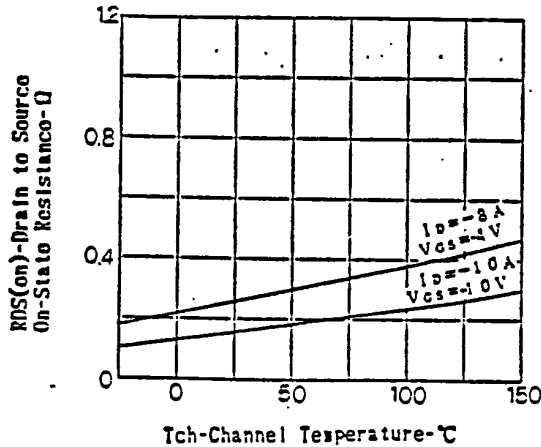

DRAIN TO SOURCE ON-STATE RESISTANCE vs. DRAIN CURRENT

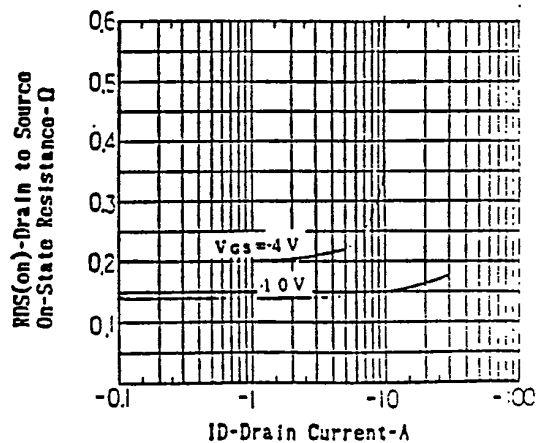



TRANSFER CHARACTERISTICS

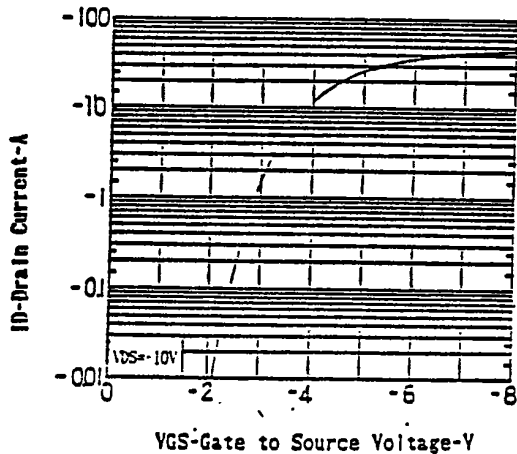

GATE TO SOURCE CUTOFF VOLTAGE vs. CHANNEL TEMPERATURE

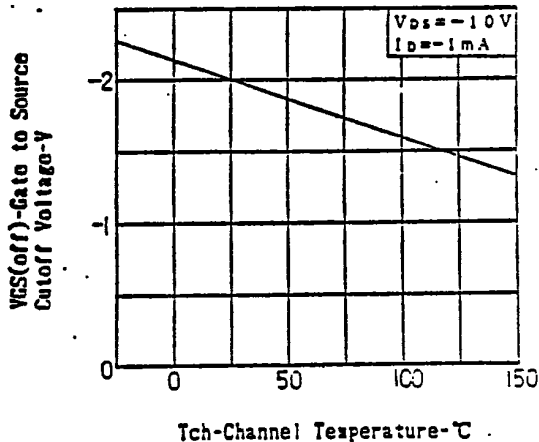

SWITCHING TIME vs. DRAIN CURRENT

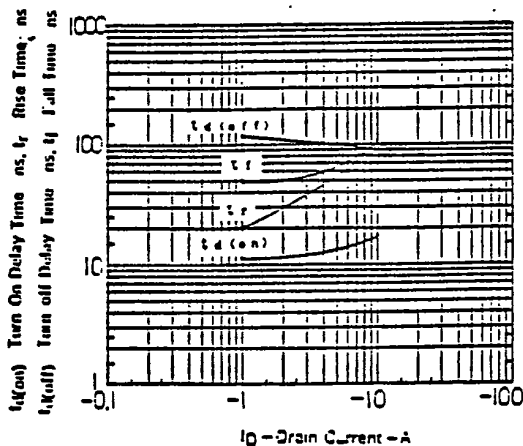

NEC Corporation

INTERNATIONAL ELECTRON DEVICES DIV.
 NEC Building, 33-1, Shiba Gochome
 Minato-ku, Tokyo 108, Japan
 Tel: Tokyo 454-1111
 Telex Address: NECTOK J22686
 Cable Address: MICROPHONE TOKYO

4