

2SD2137, 2SD2137A

Silicon NPN triple diffusion planar type

For power amplification

Complementary to 2SB1417 and 2SB1417A

Features

- High forward current transfer ratio h_{FE} which has satisfactory linearity
- Low collector to emitter saturation voltage $V_{CE(sat)}$
- Allowing supply with the radial tapering

Absolute Maximum Ratings ($T_C=25^\circ\text{C}$)

Parameter	Symbol	Ratings	Unit	
Collector to base voltage	V_{CBO}	60	V	
2SD2137A		80		
Collector to emitter voltage	V_{CEO}	60	V	
2SD2137A		80		
Emitter to base voltage	V_{EBO}	6	V	
Peak collector current	I_{CP}	5	A	
Collector current	I_C	3	A	
Collector power dissipation	P_C	$T_C=25^\circ\text{C}$	15	W
$T_a=25^\circ\text{C}$		2		
Junction temperature	T_j	150	$^\circ\text{C}$	
Storage temperature	T_{stg}	-55 to +150	$^\circ\text{C}$	

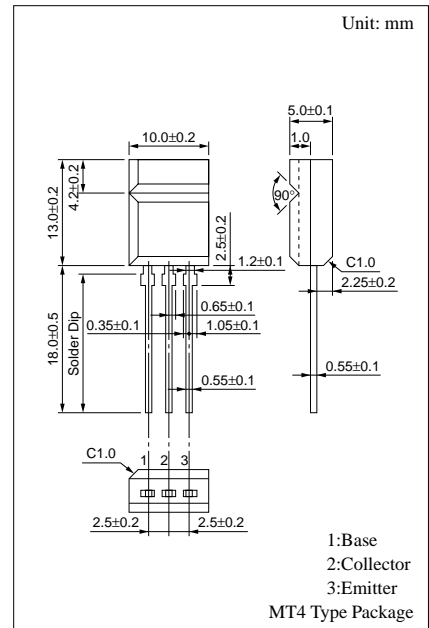

Electrical Characteristics ($T_C=25^\circ\text{C}$)

Parameter	Symbol	Conditions	min	typ	max	Unit
Collector cutoff current	I_{CES}	$V_{CE} = 60\text{V}, V_{BE} = 0$			100	μA
2SD2137A		$V_{CE} = 80\text{V}, V_{BE} = 0$			100	
Collector cutoff current	I_{CEO}	$V_{CE} = 30\text{V}, I_B = 0$			100	μA
2SD2137A		$V_{CE} = 60\text{V}, I_B = 0$			100	
Emitter cutoff current	I_{EBO}	$V_{EB} = 6\text{V}, I_C = 0$			100	μA
Collector to emitter voltage	V_{CEO}	$I_C = 30\text{mA}, I_B = 0$	60			V
2SD2137A			80			
Forward current transfer ratio	h_{FE1}^*	$V_{CE} = 4\text{V}, I_C = 1\text{A}$	70		250	
	h_{FE2}	$V_{CE} = 4\text{V}, I_C = 3\text{A}$	10			
Base to emitter voltage	V_{BE}	$V_{CE} = 4\text{V}, I_C = 3\text{A}$			1.8	V
Collector to emitter saturation voltage	$V_{CE(sat)}$	$I_C = 3\text{A}, I_B = 0.375\text{A}$			1.2	V
Transition frequency	f_T	$V_{CE} = 5\text{V}, I_C = 0.2\text{A}, f = 10\text{MHz}$		30		MHz
Turn-on time	t_{on}	$I_C = 1\text{A}, I_{B1} = 0.1\text{A}, I_{B2} = -0.1\text{A}, V_{CC} = 50\text{V}$		0.3		μs
Storage time	t_{stg}			2.5		μs
Fall time	t_f			0.2		μs

* h_{FE1} Rank classification

Rank	Q	P
h_{FE1}	70 to 150	120 to 250

Note: Ordering can be made by the common rank (PQ rank $h_{FE} = 70$ to 250) in the rank classification.

$P_C - T_a$

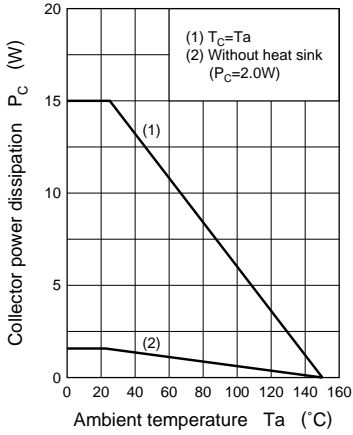

$I_C - V_{CE}$

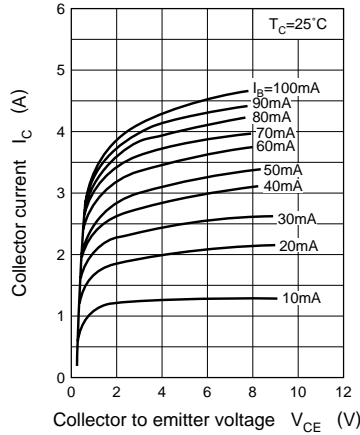

$V_{CE(sat)} - I_C$

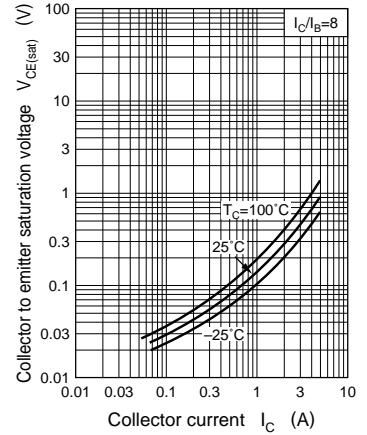

$I_C - V_{BE}$

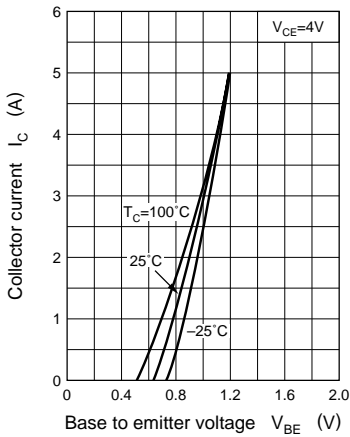

$h_{FE} - I_C$

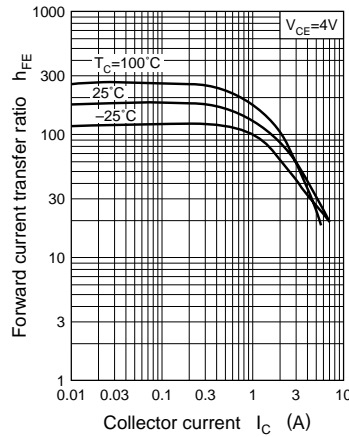

$f_T - I_C$

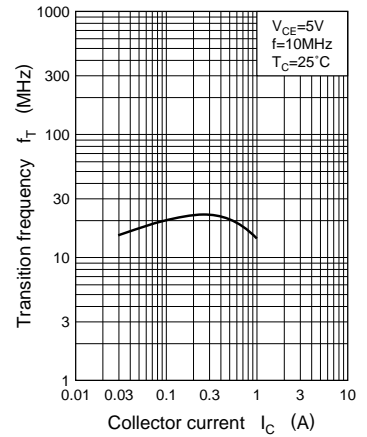

$C_{ob} - V_{CB}$

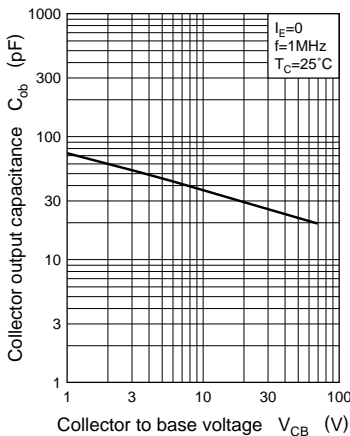

$t_{on}, t_{stg}, t_f - I_C$

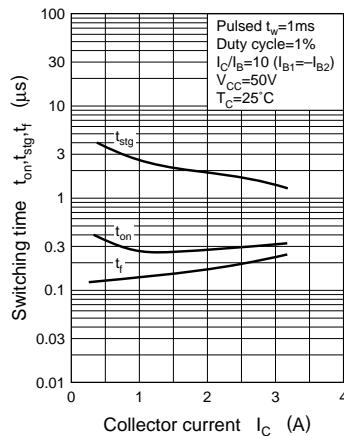

Area of safe operation (ASO)

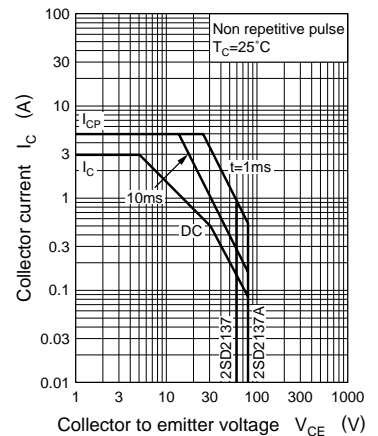

$$R_{th(t)} - t$$

