

**NPN SILICON EPITAXIAL TRANSISTOR**  
**3 PINS ULTRA SUPER MINI MOLD**

**DESCRIPTION**

The 2SC5005 is a low supply voltage transistor designed for UHF OSC/MIX.

It is suitable for a high density surface mount assembly since the transistor has been applied ultra super mini mold package.

**FEATURES**

- High  $f_t$  : 5.5 GHz TYP. (@  $V_{CE} = 5\text{ V}$ ,  $I_c = 5\text{ mA}$ ,  $f = 1\text{ GHz}$ )
- Low  $C_{re}$  : 0.7 pF TYP. (@  $V_{CB} = 5\text{ V}$ ,  $I_E = 0$ ,  $f = 1\text{ MHz}$ )
- Ultra Super Mini Mold Package. (1.6 mm × 0.8 mm)

**ORDERING INFORMATION**

PART NUMBER	QUANTITY	PACKING STYLE
2SC5005	50 pcs./unit	Embossed tape 8 mm wide. Pin 3 (Collector) face to perforation side of the tape.
2SC5005 – T1	3 kpcs./Reel	

\* Please contact with responsible NEC person, if you require evaluation sample. Unit sample quantity shall be 50 pcs.

**ABSOLUTE MAXIMUM RATINGS ( $T_a = 25\text{ °C}$ )**

Collector to Base Voltage	$V_{CBO}$	20	V
Collector to Emitter Voltage	$V_{CEO}$	12	V
Emitter to Base Voltage	$V_{EBO}$	3	V
Collector Current	$I_c$	30	mA
Total Power Dissipation	$P_T$	100	mW
Junction Temperature	$T_j$	125	°C
Storage Temperature	$T_{stg}$	-55 to +125	°C

**PACKAGE DIMENSIONS**

in millimeters

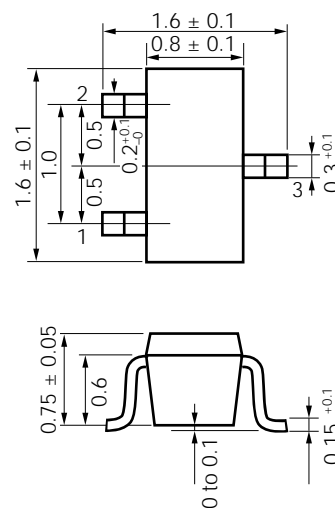

**PIN CONNECTIONS**

1. Emitter
2. Base
3. Collector

**ELECTRICAL CHARACTERISTICS (T<sub>A</sub> = 25 °C)**

CHARACTERISTIC	SYMBOL	MIN.	TYP.	MAX.	UNIT	TEST CONDITION
Collector Cutoff Current	I <sub>CBO</sub>			0.1	μA	V <sub>CB</sub> = 15 V, I <sub>E</sub> = 0
Emitter Cutoff Current	I <sub>EBO</sub>			0.1	μA	V <sub>EB</sub> = 1 V, I <sub>C</sub> = 0
Collector Saturation Voltage	V <sub>CE(sat)</sub>			0.5	V	h <sub>FE</sub> = 10, I <sub>C</sub> = 5 mA
DC Current Gain	h <sub>FE</sub>	60		120		V <sub>CE</sub> = 5 V, I <sub>C</sub> = 5 mA*1
Gain Bandwidth Product	f <sub>T</sub>	3.0	5.5		GHz	V <sub>CE</sub> = 5 V, I <sub>C</sub> = 5 mA
Feed-back Capacitance	C <sub>re</sub>		0.7	0.9	pF	V <sub>CB</sub> = 5 V, I <sub>E</sub> = 0, f = 1 MHz *2
Insertion Power Gain	S <sub>21e</sub>   <sup>2</sup>	5.0			dB	V <sub>CE</sub> = 5 V, I <sub>C</sub> = 5 mA, f = 1 GHz

\*1 Pulse Measurement PW ≤ 350 μs, Duty Cycle ≤ 2 %

\*2 The emitter terminal and the case shall be connected to the guard terminal of the three-terminal capacitance bridge.

**h<sub>FE</sub> Classification**

Rank	FB
Marking	73
h <sub>FE</sub>	60 to 120

TYPICAL CHARACTERISTICS (T<sub>A</sub> = 25 °C)

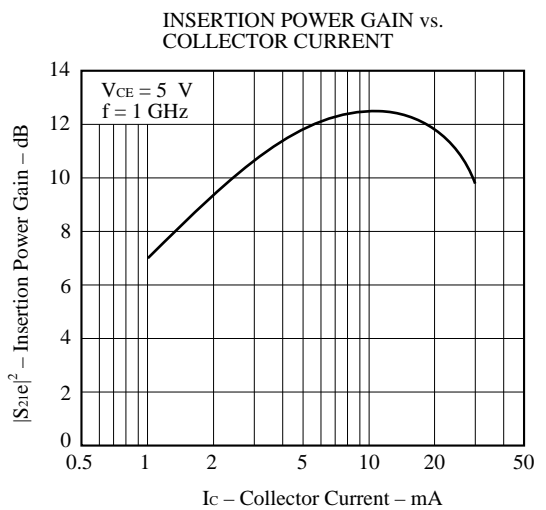
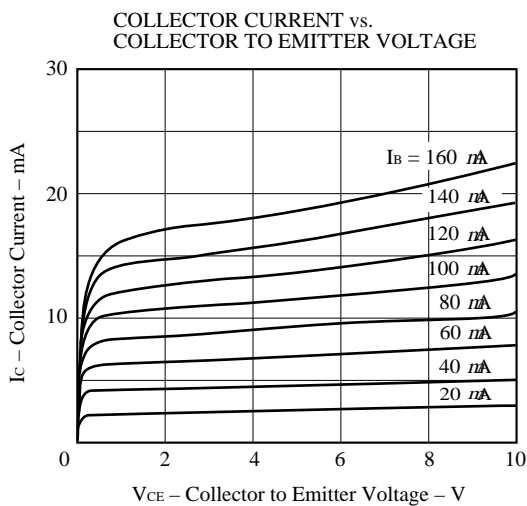
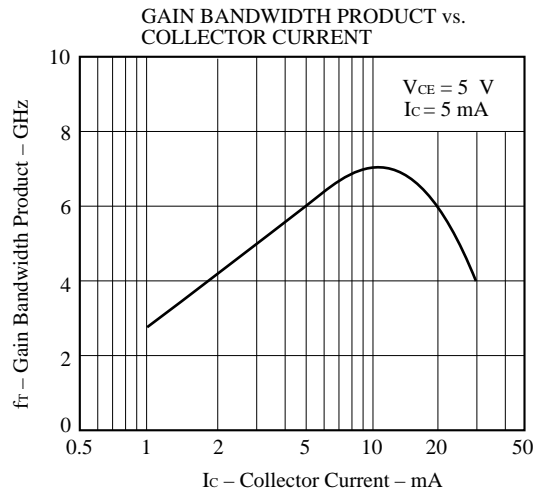
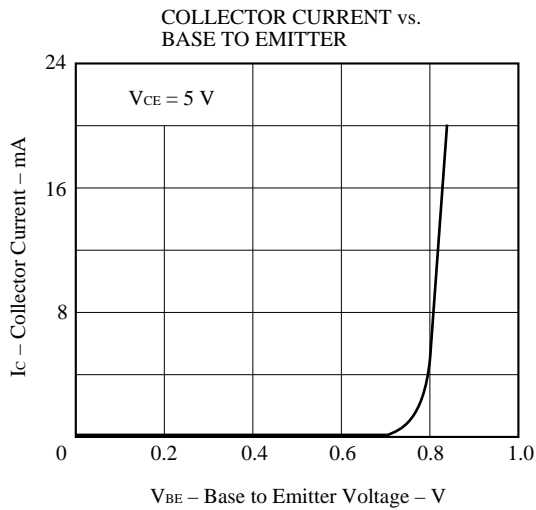
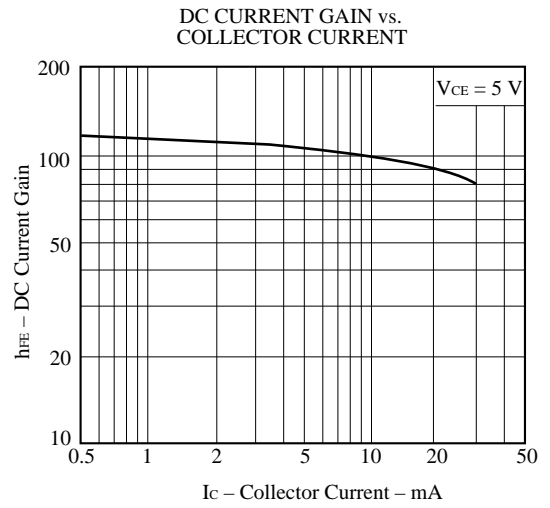
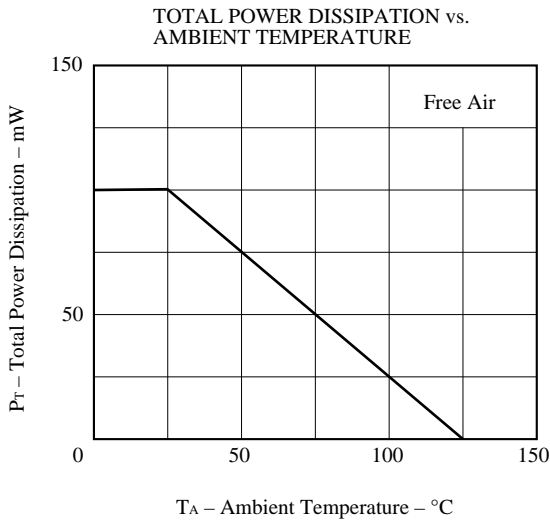

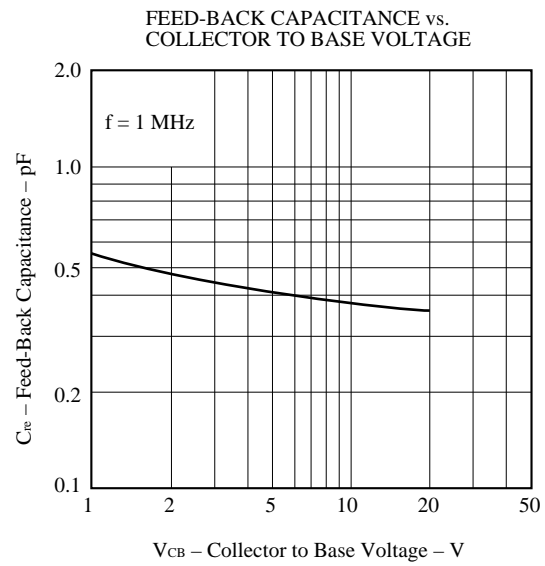
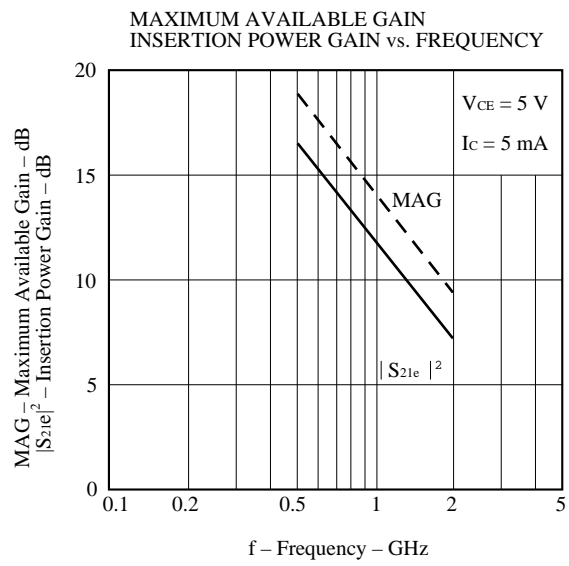

S-PARAMETER

V<sub>CE</sub> = 5 V, I<sub>c</sub> = 5 mA, Z<sub>o</sub> = 50 Ω

FREQUENCY	S <sub>11</sub>		S <sub>21</sub>		S <sub>12</sub>		S <sub>22</sub>	
	MHz	MAG	ANG	MAG	ANG	MAG	ANG	MAG
100.00	.862	-19.6	8.912	154.5	.026	72.7	.940	-14.3
200.00	.769	-37.2	8.353	135.7	.045	61.1	.830	-25.1
300.00	.661	-54.8	7.788	119.9	.059	52.6	.718	-31.2
400.00	.559	-70.7	7.068	106.4	.070	46.6	.638	-34.6
500.00	.468	-85.5	6.414	94.3	.080	43.1	.575	-37.0
600.00	.406	-96.9	5.640	84.3	.088	39.8	.530	-38.4
700.00	.351	-108.2	5.086	75.2	.097	36.5	.495	-39.4
800.00	.315	-118.4	4.580	66.8	.105	32.9	.468	-40.5
900.00	.287	-128.3	4.167	59.2	.114	30.5	.444	-41.3
1000.00	.268	-137.3	3.829	52.2	.123	27.3	.426	-42.7
1100.00	.254	-145.8	3.532	45.5	.131	24.2	.409	-43.5
1200.00	.245	-154.4	3.282	38.9	.140	21.0	.395	-45.0
1300.00	.240	-162.3	3.061	32.6	.149	17.9	.384	-46.4
1400.00	.238	-169.3	2.876	26.6	.158	14.1	.372	-48.2
1500.00	.240	-176.3	2.711	20.7	.167	10.9	.361	-49.8
1600.00	.243	177.2	2.572	14.6	.176	7.4	.350	-51.6
1700.00	.246	171.2	2.446	8.9	.185	3.7	.341	-53.6
1800.00	.252	165.8	2.327	2.9	.194	.3	.330	-55.2
1900.00	.260	160.5	2.222	-2.5	.203	-3.3	.320	-57.7
2000.00	.269	155.5	2.129	-8.3	.213	-7.1	.312	-60.0
2100.00	.278	151.2	2.053	-13.7	.222	-10.8	.300	-62.6
2200.00	.286	147.5	1.974	-19.3	.231	-14.6	.292	-65.4
2300.00	.297	143.4	1.912	-24.7	.241	-18.5	.282	-68.1
2400.00	.307	140.0	1.845	-30.1	.250	-22.4	.271	-71.2
2500.00	.319	136.8	1.789	-35.3	.258	-26.1	.260	-74.2
2600.00	.330	133.8	1.738	-40.7	.267	-30.2	.252	-78.2
2700.00	.341	130.9	1.691	-46.0	.275	-34.2	.242	-82.1
2800.00	.353	128.2	1.638	-51.2	.285	-38.1	.233	-85.9
2900.00	.364	125.4	1.594	-56.3	.293	-42.1	.225	-90.2
3000.00	.378	122.9	1.552	-61.5	.302	-46.0	.218	-94.9

V<sub>CE</sub> = 5 V, I<sub>c</sub> = 3 mA, Z<sub>o</sub> = 50 Ω

FREQUENCY	S <sub>11</sub>		S <sub>21</sub>		S <sub>12</sub>		S <sub>22</sub>	
	MHz	MAG	ANG	MAG	ANG	MAG	ANG	MAG
100.00	.922	-14.0	5.626	157.8	.026	76.4	.968	-10.6
200.00	.862	-28.7	5.479	142.0	.050	64.6	.900	-20.0
300.00	.785	-42.7	5.345	127.7	.067	54.4	.813	-26.3
400.00	.707	-56.1	5.052	115.2	.080	46.8	.742	-31.2
500.00	.623	-69.5	4.849	103.5	.091	40.8	.679	-34.6
600.00	.557	-80.2	4.385	92.9	.101	35.6	.630	-37.2
700.00	.487	-91.6	4.130	82.8	.108	31.8	.588	-39.1
800.00	.434	-102.1	3.838	73.4	.117	28.0	.554	-40.7
900.00	.389	-111.9	3.562	64.8	.124	24.6	.524	-42.2
1000.00	.355	-121.1	3.330	57.0	.131	21.5	.502	-43.5
1100.00	.328	-130.0	3.114	49.5	.138	18.2	.481	-44.8
1200.00	.308	-139.0	2.909	42.5	.146	14.6	.464	-46.4
1300.00	.293	-147.0	2.739	35.7	.155	11.8	.449	-48.0
1400.00	.285	-155.0	2.577	29.1	.161	8.7	.436	-49.7
1500.00	.279	-162.6	2.440	22.7	.168	5.3	.423	-51.4
1600.00	.277	-169.6	2.323	16.6	.176	2.3	.410	-53.2
1700.00	.275	-176.5	2.212	10.3	.184	-1.3	.399	-55.2
1800.00	.277	177.2	2.115	4.2	.193	-4.2	.389	-57.1
1900.00	.281	170.8	2.024	-1.5	.200	-7.6	.378	-59.4
2000.00	.287	165.0	1.951	-7.3	.209	-10.9	.369	-61.8
2100.00	.294	159.6	1.881	-13.2	.217	-14.5	.358	-64.4
2200.00	.300	155.5	1.809	-18.7	.225	-17.8	.350	-66.8
2300.00	.310	150.6	1.756	-24.4	.234	-21.4	.339	-69.7
2400.00	.319	146.6	1.695	-30.0	.242	-25.2	.329	-72.7
2500.00	.330	142.9	1.647	-35.4	.249	-28.8	.318	-75.7
2600.00	.339	139.1	1.598	-40.8	.259	-32.5	.310	-79.4
2700.00	.350	135.6	1.557	-46.3	.268	-36.3	.301	-82.8
2800.00	.361	132.4	1.511	-51.6	.275	-39.6	.291	-86.8
2900.00	.372	129.3	1.473	-56.9	.284	-43.6	.284	-90.6
3000.00	.385	126.4	1.436	-62.1	.293	-47.3	.278	-95.0

**S-PARAMETER**

V<sub>CE</sub> = 5 V, I<sub>c</sub> = 1 mA, Z<sub>o</sub> = 50 Ω

FREQUENCY	S <sub>11</sub>		S <sub>21</sub>		S <sub>12</sub>		S <sub>22</sub>	
	MHz	MAG	ANG	MAG	ANG	MAG	ANG	MAG
100.00	.986	-9.8	1.971	165.5	.029	78.9	.992	-5.8
200.00	.957	-19.8	2.002	150.9	.054	69.6	.973	-11.7
300.00	.929	-28.5	2.041	138.6	.079	60.1	.939	-16.7
400.00	.891	-38.1	2.023	127.1	.100	51.7	.906	-21.3
500.00	.847	-47.4	2.036	117.0	.117	43.6	.868	-25.4
600.00	.803	-55.9	1.913	106.6	.133	36.1	.837	-29.0
700.00	.754	-64.7	1.885	96.6	.144	29.6	.801	-32.2
800.00	.709	-73.6	1.851	86.8	.154	23.3	.769	-35.2
900.00	.662	-82.3	1.806	77.6	.161	17.7	.735	-37.8
1000.00	.613	-91.5	1.794	68.7	.169	12.4	.708	-40.3
1100.00	.568	-100.3	1.765	60.0	.173	7.6	.683	-42.4
1200.00	.528	-109.1	1.731	51.7	.178	3.2	.662	-44.7
1300.00	.498	-117.0	1.667	43.8	.183	-1.2	.644	-46.8
1400.00	.467	125.2	1.623	36.0	.187	-5.1	.626	-49.2
1500.00	.444	-132.9	1.569	28.5	.190	-8.9	.611	-51.4
1600.00	.426	-140.6	1.519	21.4	.193	-12.3	.595	-53.6
1700.00	.407	-148.5	1.479	14.3	.196	-15.7	.584	-55.9
1800.00	.397	-155.6	1.427	7.5	.200	-18.7	.570	-58.0
1900.00	.388	-163.0	1.389	.9	.203	-21.8	.558	-60.6
2000.00	.381	-170.3	1.354	-5.7	.207	-24.7	.549	-63.0
2100.00	.380	-177.0	1.315	-11.9	.210	-27.6	.536	-65.8
2200.00	.378	177.0	1.275	-18.1	.214	-30.5	.530	-68.5
2300.00	.381	170.8	1.251	-24.2	.218	-33.1	.518	-71.5
2400.00	.384	165.1	1.211	-30.2	.222	-35.9	.510	-74.5
2500.00	.390	159.9	1.184	-35.9	.227	-38.4	.499	-77.6
2600.00	.395	154.8	1.157	-41.8	.233	-41.3	.491	-81.1
2700.00	.400	150.1	1.132	-47.5	.239	-44.3	.483	-84.6
2800.00	.410	145.5	1.102	-53.1	.245	-46.9	.477	-88.4
2900.00	.418	141.4	1.078	-58.6	.251	-49.9	.468	-92.1
3000.00	.429	137.4	1.055	-64.1	.258	-52.6	.464	-96.1

V<sub>CE</sub> = 3 V, I<sub>c</sub> = 5 mA, Z<sub>o</sub> = 50 Ω

FREQUENCY	S <sub>11</sub>		S <sub>21</sub>		S <sub>12</sub>		S <sub>22</sub>	
	MHz	MAG	ANG	MAG	ANG	MAG	ANG	MAG
100.00	.867	-19.3	8.773	153.5	.028	71.9	.931	-16.1
200.00	.757	-39.7	8.305	134.5	.050	59.4	.810	-28.1
300.00	.646	-58.4	7.727	118.4	.065	51.1	.690	-34.9
400.00	.546	-75.5	6.944	104.8	.076	44.9	.602	-38.9
500.00	.458	-91.1	6.269	92.7	.087	41.5	.537	-41.7
600.00	.399	-103.1	5.496	82.6	.095	37.5	.488	-43.2
700.00	.350	-115.0	4.931	73.6	.104	34.6	.451	-44.4
800.00	.318	-125.6	4.440	65.3	.113	31.4	.422	-45.6
900.00	.295	-135.6	4.035	57.5	.122	28.7	.399	-46.6
1000.00	.279	-144.5	3.698	50.7	.131	25.4	.377	-48.1
1100.00	.270	-153.1	3.406	44.1	.141	22.2	.360	-49.0
1200.00	.263	-161.3	3.163	37.4	.149	19.0	.345	-50.4
1300.00	.261	-168.6	2.949	31.1	.159	16.0	.332	-51.7
1400.00	.261	-175.4	2.772	25.0	.169	12.3	.320	-54.0
1500.00	.264	178.1	2.613	19.0	.178	9.0	.307	-55.9
1600.00	.268	172.3	2.473	13.2	.187	5.4	.297	-57.7
1700.00	.273	166.4	2.344	7.2	.196	1.8	.286	-60.0
1800.00	.279	161.7	2.242	1.5	.206	-1.9	.275	-62.0
1900.00	.287	156.7	2.140	-4.4	.216	-5.5	.264	-64.8
2000.00	.297	152.1	2.056	-9.7	.225	-9.5	.256	-67.2
2100.00	.306	148.0	1.974	-15.5	.235	-13.3	.244	-70.4
2200.00	.315	144.8	1.906	-20.9	.244	-17.1	.236	-73.5
2300.00	.327	140.7	1.838	-26.4	.253	-21.2	.225	-77.2
2400.00	.336	137.5	1.775	-31.9	.262	-24.9	.215	-80.7
2500.00	.348	134.6	1.721	-37.1	.270	-28.7	.205	-84.7
2600.00	.357	131.2	1.667	-42.4	.280	-32.9	.198	-89.4
2700.00	.369	128.6	1.624	-47.7	.289	-36.8	.188	-94.2
2800.00	.381	125.8	1.573	-53.0	.298	-40.8	.181	-99.4
2900.00	.392	123.4	1.527	-58.1	.307	-45.1	.174	-104.7
3000.00	.404	120.7	1.493	-63.3	.315	-49.0	.168	-110.9

**S-PARAMETER**

V<sub>CE</sub> = 3 V, I<sub>c</sub> = 3 mA, Z<sub>o</sub> = 50 Ω

FREQUENCY	S <sub>11</sub>		S <sub>21</sub>		S <sub>12</sub>		S <sub>22</sub>	
	MHz	MAG	ANG	MAG	ANG	MAG	ANG	MAG
100.00	.927	-15.4	5.565	158.7	.030	74.8	.961	-11.9
200.00	.854	-30.3	5.460	141.0	.055	62.3	.887	-22.2
300.00	.773	-45.0	5.302	126.4	.074	52.8	.792	-29.4
400.00	.695	-59.3	4.990	113.7	.088	45.0	.715	-34.5
500.00	.610	-73.4	4.776	101.8	.100	39.0	.646	-38.3
600.00	.546	-84.6	4.313	91.2	.109	34.2	.595	-41.2
700.00	.477	-96.7	4.041	81.1	.117	29.8	.550	-43.3
800.00	.428	-107.5	3.741	71.6	.125	25.9	.514	-45.2
900.00	.388	-117.9	3.476	63.1	.133	22.3	.484	-46.7
1000.00	.356	-127.6	3.230	55.2	.140	19.4	.458	-48.2
1100.00	.334	-136.5	3.014	47.7	.149	16.0	.437	-49.6
1200.00	.317	-145.4	2.817	40.8	.156	13.2	.419	-51.3
1300.00	.305	-153.4	2.644	33.9	.164	9.7	.403	-52.9
1400.00	.298	-161.0	2.495	27.4	.173	6.7	.389	-55.0
1500.00	.295	-168.4	2.360	20.9	.179	3.1	.375	-56.9
1600.00	.295	-175.2	2.246	14.8	.187	-1	.361	-58.9
1700.00	.295	178.4	2.138	8.6	.195	-3.4	.350	-60.8
1800.00	.297	172.5	2.042	2.5	.205	-6.9	.338	-63.0
1900.00	.304	166.7	1.958	-3.5	.213	-10.1	.326	-65.5
2000.00	.310	161.0	1.885	-9.2	.221	-13.4	.319	-68.4
2100.00	.319	156.1	1.811	-15.0	.229	-17.1	.306	-71.1
2200.00	.325	152.0	1.752	-20.7	.238	-20.7	.297	-74.1
2300.00	.336	147.6	1.695	-26.3	.246	-24.3	.287	-77.3
2400.00	.344	143.7	1.636	-31.8	.254	-27.9	.276	-80.7
2500.00	.355	140.0	1.587	-37.2	.261	-31.5	.267	-84.3
2600.00	.365	136.4	1.541	-42.8	.271	-35.3	.259	-88.4
2700.00	.375	133.3	1.501	-48.1	.280	-38.9	.250	-92.5
2800.00	.386	130.1	1.456	-53.5	.288	-42.9	.241	-97.3
2900.00	.397	127.2	1.415	-58.7	.296	-46.8	.235	-101.9
3000.00	.408	124.2	1.382	-64.0	.305	-50.3	.229	-106.8

V<sub>CE</sub> = 3 V, I<sub>c</sub> = 1 mA, Z<sub>o</sub> = 50 Ω

FREQUENCY	S <sub>11</sub>		S <sub>21</sub>		S <sub>12</sub>		S <sub>22</sub>	
	MHz	MAG	ANG	MAG	ANG	MAG	ANG	MAG
100.00	.983	-9.9	1.946	164.5	.032	79.0	.990	-6.5
200.00	.956	-19.8	2.001	150.1	.062	69.1	.969	-12.7
300.00	.925	-29.7	2.042	137.5	.087	59.7	.931	-18.2
400.00	.884	-39.6	2.016	125.7	.110	50.3	.896	-23.2
500.00	.840	-49.4	2.025	115.5	.130	42.4	.853	-27.7
600.00	.796	-58.1	1.896	104.7	.146	34.2	.818	-31.6
700.00	.744	-67.4	1.869	94.6	.158	27.7	.779	-35.0
800.00	.699	-76.6	1.830	84.7	.169	21.4	.745	-38.2
900.00	.651	-85.6	1.786	75.4	.177	15.6	.708	-40.9
1000.00	.605	-95.0	1.777	66.3	.185	10.0	.680	-43.6
1100.00	.560	-104.0	1.741	57.6	.189	5.3	.653	-46.0
1200.00	.521	-113.1	1.699	49.3	.195	.9	.629	-48.3
1300.00	.493	-121.1	1.638	41.3	.199	-3.5	.611	-50.4
1400.00	.466	-129.5	1.590	33.7	.202	-7.5	.591	-53.0
1500.00	.444	-137.3	1.533	26.2	.205	-11.3	.575	-55.3
1600.00	.428	-145.0	1.486	19.1	.208	-15.0	.560	-57.6
1700.00	.413	-152.8	1.444	11.9	.211	-18.7	.546	-60.1
1800.00	.402	-159.8	1.397	5.2	.213	-21.7	.532	-62.5
1900.00	.397	-167.2	1.356	-1.6	.217	-24.9	.519	-65.2
2000.00	.392	-174.4	1.322	-8.0	.220	-27.9	.511	-67.8
2100.00	.391	179.4	1.280	-14.3	.223	-30.9	.497	-70.8
2200.00	.393	173.5	1.243	-20.5	.228	-33.8	.488	-73.8
2300.00	.396	167.3	1.219	-26.5	.231	-36.8	.477	-76.8
2400.00	.400	162.0	1.180	-32.6	.236	-39.7	.469	-80.2
2500.00	.405	157.1	1.153	-38.3	.241	-42.3	.458	-83.5
2600.00	.410	152.0	1.127	-44.2	.246	-45.2	.451	-87.2
2700.00	.417	147.4	1.101	-49.8	.250	-48.0	.443	-91.1
2800.00	.429	143.3	1.072	-55.5	.256	-50.6	.435	-95.1
2900.00	.435	139.2	1.048	-60.9	.263	-53.8	.428	-99.2
3000.00	.445	135.3	1.024	-66.4	.269	-56.5	.424	-103.6

**[MEMO]**

No part of this document may be copied or reproduced in any form or by any means without the prior written consent of NEC Corporation. NEC Corporation assumes no responsibility for any errors which may appear in this document.

NEC Corporation does not assume any liability for infringement of patents, copyrights or other intellectual property rights of third parties by or arising from use of a device described herein or any other liability arising from use of such device. No license, either express, implied or otherwise, is granted under any patents, copyrights or other intellectual property rights of NEC Corporation or others.

While NEC Corporation has been making continuous effort to enhance the reliability of its semiconductor devices, the possibility of defects cannot be eliminated entirely. To minimize risks of damage or injury to persons or property arising from a defect in an NEC semiconductor device, customer must incorporate sufficient safety measures in its design, such as redundancy, fire-containment, and anti-failure features.

NEC devices are classified into the following three quality grades:

"Standard", "Special", and "Specific". The Specific quality grade applies only to devices developed based on a customer designated "quality assurance program" for a specific application. The recommended applications of a device depend on its quality grade, as indicated below. Customers must check the quality grade of each device before using it in a particular application.

Standard: Computers, office equipment, communications equipment, test and measurement equipment, audio and visual equipment, home electronic appliances, machine tools, personal electronic equipment and industrial robots

Special: Transportation equipment (automobiles, trains, ships, etc.), traffic control systems, anti-disaster systems, anti-crime systems, safety equipment and medical equipment (not specifically designed for life support)

Specific: Aircrafts, aerospace equipment, submersible repeaters, nuclear reactor control systems, life support systems or medical equipment for life support, etc.

The quality grade of NEC devices in "Standard" unless otherwise specified in NEC's Data Sheets or Data Books. If customers intend to use NEC devices for applications other than those specified for Standard quality grade, they should contact NEC Sales Representative in advance.

Anti-radioactive design is not implemented in this product.